

Lecture Notes in Management and Industrial Engineering

José Luis Ayuso Muñoz  
José Luis Yagüe Blanco  
Salvador F. Capuz-Rizo *Editors*

# Project Management and Engineering Research

AEIPRO 2017

 Springer

# **Lecture Notes in Management and Industrial Engineering**

**Series editor**

Adolfo López-Paredes, Valladolid, Spain

This book series provides a means for the dissemination of current theoretical and applied research in the areas of Industrial Engineering & Engineering Management. The latest methodological and computational advances that both researchers and practitioners can widely apply to solve new and classical problems in industries and organizations constitute a growing source of publications written for and by our readership.

The aim of this book series is to facilitate the dissemination of current research in the following topics:

- Strategy and Entrepreneurship;
- Operations Research, Modelling and Simulation;
- Logistics, Production and Information Systems;
- Quality Management;
- Product Management;
- Sustainability and Ecoefficiency;
- Industrial Marketing and Consumer Behavior;
- Knowledge and Project Management;
- Risk Management;
- Service Systems;
- Healthcare Management;
- Human Factors and Ergonomics;
- Emergencies and Disaster Management; and
- Education.

More information about this series at <http://www.springer.com/series/11786>

José Luis Ayuso Muñoz  
José Luis Yagüe Blanco  
Salvador F. Capuz-Rizo  
Editors

# Project Management and Engineering Research

AEIPRO 2017

 Springer

*Editors*

José Luis Ayuso Muñoz  
Universidad de Córdoba  
Córdoba, Spain

Salvador F. Capuz-Rizo  
Universitat Politècnica de València  
Valencia, Spain

José Luis Yagüe Blanco  
Universidad Politécnica de Madrid  
Madrid, Spain

ISSN 2198-0772                      ISSN 2198-0780 (electronic)  
Lecture Notes in Management and Industrial Engineering  
ISBN 978-3-319-92272-0              ISBN 978-3-319-92273-7 (eBook)  
<https://doi.org/10.1007/978-3-319-92273-7>

Library of Congress Control Number: 2018949056

© Springer International Publishing AG, part of Springer Nature 2019

This work is subject to copyright. All rights are reserved by the Publisher, whether the whole or part of the material is concerned, specifically the rights of translation, reprinting, reuse of illustrations, recitation, broadcasting, reproduction on microfilms or in any other physical way, and transmission or information storage and retrieval, electronic adaptation, computer software, or by similar or dissimilar methodology now known or hereafter developed.

The use of general descriptive names, registered names, trademarks, service marks, etc. in this publication does not imply, even in the absence of a specific statement, that such names are exempt from the relevant protective laws and regulations and therefore free for general use.

The publisher, the authors and the editors are safe to assume that the advice and information in this book are believed to be true and accurate at the date of publication. Neither the publisher nor the authors or the editors give a warranty, express or implied, with respect to the material contained herein or for any errors or omissions that may have been made. The publisher remains neutral with regard to jurisdictional claims in published maps and institutional affiliations.

This Springer imprint is published by the registered company Springer Nature Switzerland AG  
The registered company address is: Gewerbestrasse 11, 6330 Cham, Switzerland

# Contents

## Part I Project Management

<b>Predictive Tools for Project Performance Management in the Construction Industry</b> .....	3
A. Cerezo, A. Pastor, M. Otero and J. M. Portela	
<b>Expanding the Knowledge on Project Management Standards: A Look into the PMBOK® with Dynamic Lenses</b> .....	19
V. Hermano and N. Martín-Cruz	
<b>Lean Thinking: A Useful Tool to Integrate Sustainability into Project Management</b> .....	35
C. Cruz-Villazon, J. R. Otegi-Olaso, M. E. Aguilar-Fernandez and L. Fuentes-Ardeo	

## Part II Civil Engineering and Urban Planning: Construction and Architecture

<b>Planning and Control of Civil Engineering Works in Peru: Current State and Improvement Proposal</b> .....	51
P. M. Carbajal, E. Pellicer, S. Santos-Fonseca, C. Torres-Machi and P. Ballesteros-Pérez	
<b>Experiences on MEF Simulation for Linear Concrete Elements with the ATENA Tool</b> .....	67
S. Laserna, E. Alcázar, J. Cervera and J. Montero	

## Part III Product and Process Engineering and Industrial Design

<b>Study on Optimization of the Tuna-Fishing Vessel Construction Project, Through Production Oriented Design</b> .....	85
C. Mascaraque-Ramírez, L. Para-González and D. Moreno-Sánchez	

<b>A Critical Evaluation of Cathode Materials for Lithium-Ion Electric Vehicle Batteries</b> .....	99
Robert Reinhardt, B. Amante García, Lluç Canals Casals and S. Gassó Domingo	
<b>Design and Structural Analysis of a Prosthesis for an Arthroplasty. Definition of the Osseointegration Grade During the Rehabilitation Process</b> .....	111
F. Cavas-Martínez, D. Parras-Burgos, J. Nieto, F. J. F. Cañavate and D. G. Fernández-Pacheco	
<b>MOTIVA-PRO: Innovation Based on Users' Motivations</b> .....	127
D. Justel, A. Retegi, I. Iriarte, G. Lasa and I. González	
<b>Part IV Environmental Engineering and Management of Natural Resources</b>	
<b>Combined System UASB+MBR for the Biological Elimination of Emerging Contaminants, Organic Matter and Nutrients in Urban Waste Water</b> .....	145
M. J. Moya-Llamas, M. A. Bernal-Romero del Hombre Bueno, E. D. Vásquez-Rodríguez, A. Trapote, C. M. López-Ortiz and D. Prats	
<b>Identification of Environmental Risk Areas Using Pollution Indexes and Geographic Information Systems</b> .....	159
J. A. Acosta, M. D. Gómez-López, A. Faz, R. Zornoza and S. Martínez-Martínez	
<b>Part V Energy Efficiency and Renewable Energies</b>	
<b>Review of Numerical Models for Studying the Dynamic Response of Deep Foundations for the Design and Project of Wind Turbines</b> .....	173
G. M. Álamo, J. D. R. Bordón, F. García, J. J. Aznárez, L. A. Padrón, F. Chirino and O. Maeso	
<b>Development and Characterization of Modular Ceramic and Metal Elements in Vertical Gardens and Ventilated Façades in Buildings</b> .....	189
V. Pérez-Andreu, C. Aparicio-Fernández, F. Castilla and J.-L. Vivancos	
<b>Qualitative Analysis on Risk Assessment in Photovoltaic Installations: Case Study in the Dominican Republic</b> .....	203
Guido C. Guerrero-Liquet, M. Socorro García-Cascales and Juan M. Sánchez-Lozano	
<b>Optimal Thickness for Isolating Foams in Buildings</b> .....	217
P. Arrué, A. C. Cárcel, A. M. Romero and C. Aparicio	

**Evaluation of the Biomass Potential in the Region of Murcia (Spain): Application to Heat/Cooling Requirements in Industrial Parks (Energing Life+)** . . . . . 233  
A. Molina-García, J. M. Paredes-Parra, M. S. García-Cascales and J. Serrano

**Financing Models for Sustainable Energy Communities in the United States of America** . . . . . 243  
Romero-Rubio and Díaz De Andrés

**Optimization of Large Offshore Wind Farms Implementation** . . . . . 257  
Bahamonde and Mena

**A Computational Study of the Aerodynamic Hiding Factor Between Panels' Arrays for the Optimization of Support Structures in Solar Parks** . . . . . 271  
R. Escrivá-Pla and C. R. Sánchez-Carratalá

**Part VI Safety, Labour Risks and Ergonomics**

**Assessment of the Thermal Stress Risk During the Construction of a Warehouse** . . . . . 287  
J. L. Fuentes-Bargues, A. M. Revuelta-Arnao and M. C. González-Cruz



**Part I**  
**Project Management**

# Predictive Tools for Project Performance Management in the Construction Industry



A. Cerezo, A. Pastor, M. Otero and J. M. Portela

**Keywords** Predictive tools · Project definition rating index · PDRI  
Earned value management · EVM · Project performance

## 1 Introduction

During the 2009–2015 period, the construction industry in Spain has experienced a state of crisis that has forced companies to rethink their strategies, both for their survival in the present and the carrying out of their activities in the future. On a macroeconomic level, there are numerous economic indicators that reflect the seriousness of this crisis:

- Production has dropped by 82.95% (CSCAE 2016)
- The number of workers has decreased by 65.75% (SGEEE 2016)
- The volume of business has fallen by 67.70% (SGEEE 2016)
- Contribution to the GDP has gone down by 57.20% (INE 2016)

Furthermore, relative to the failure of construction projects, on a worldwide level, it must be noted that (KPMG 2015):

- <31% of projects finish within 110% of the planned budget
- <25% of projects finish within 110% of the planned schedule

Within this context of serious economic crisis, high failure rate of projects undertaken and growing complexity, in both technical and socio-economic terms, of the construction process, the companies belonging to the sector need to establish a competitive advantage, through extending their market share and/or creating new

---

A. Cerezo (✉) · A. Pastor · M. Otero · J. M. Portela  
TEP-955 INTELPREV Research Group, Dept. of Mechanical Engineering and Industrial Design, Higher School of Engineering, University of Cadiz, Universidad de Cádiz Avenue, 10, 11519 Puerto Real, Spain  
e-mail: alberto.cerezo@uca.es

business lines; with project management arising as a solution to this as it provides efficient information on the interests and needs of clients and other stakeholders.

The use of mature project management methods, generates multiple benefits for companies (Fortune et al. 2011), and is therefore becoming an increasingly important topic for companies, as can be appreciated in the growing number of professional bodies, certifications, guidelines and methodologies aimed at reducing the number of projects failing (Davis 2014).

In construction projects, it is necessary, furthermore, for the stakeholders to reflect appropriately their respective requirements from the early stages of the project (Heywood and Smith 2006), with the following being necessary:

- Identification of the elements that must be considered for the definition of the project in the planning stage
- Analysis of the interrelationships and interactions between these elements in order to formulate the network structure model
- Determination of the level of importance of each element, in terms of its contribution to the project
- Investigation of the interests and concerns of the stakeholders in defining the elements of the project, in order to formulate the hierarchical structure model
- Study of the degree of the contribution of each of the stakeholders in the improvement of the integrity of each element of the project scope
- Development of an assessment tool to measure the level of definition of project scope, in accordance with the input of the stakeholders

In this respect, scope management is an instrument that allows project management to have at its disposal sufficient and necessary information to carry the projects to their successful ends (PMI 2013) (IPMA 2015), implying:

- Definition of all the work involved in the project, identifying and including it 100%, breaking it down in order to estimate the effort required for its completion
- Definition of project deliverables, ensuring the implication and commitment of the stakeholders
- Assignment of roles and responsibilities, linking the work breakdown structure -WBS- to the organigram of the project
- Providing the remaining agents with a clear vision of the final results expected from the project, after its execution, covering the needs and expectations of the stakeholders
- Providing a referential framework, that serves as a base for project communication, organizing the information relative to its associated variance
- Control of the project, facilitating a comparison of what is actually carried out with that budgeted
- Generation of more accurate schedules and cost budgets

In contrast, a badly defined scope is one of the main causes of the failure of a project, adversely affecting it in terms of cost, time and operational characteristics (Wang 2002), all of which makes scope management essential.

## 2 Objectives

The general objective of this research is to show the usefulness of predictive tools in project management in the construction sector, both to verify the implantation of associated management systems, and once they have been implemented, to evaluate the planning and execution of the projects run under these systems. As a consequence, at the same time, the status and progress of the projects is also checked, and therefore the management systems implanted are validated and verified.

## 3 Methodology

The methodology employed by this research consists of the following steps:

In the first place, a scope management system is modelled, establishing the preliminary steps necessary to successfully proceed to the implantation of the system, depending on the project management culture of the intervening organizations, on the competence of their members -construction companies- and on their maturity, with skills-based and processes-based approaches being chosen as the appropriate perspectives from which to tackle this.

Below, predictive tools are selected to evaluate the performance of those projects in which the management system will be implanted:

- Project definition rating index -PDRI-
- Earned value management -EVM-

Next, projects were chosen for the implantation of the system. Finally, the results obtained were checked and compared with historical results.

### 3.1 *Modelling of the System*

Scope management considers what can be done in the projects, why it should be done -the needs to be covered-, and how it can be done -in good time, with good quality and within cost-, playing a key role in the definition of the results of the project, in performance terms (Camilleri 2011).

Furthermore, the aim of defining the project is to provide the necessary information to identify the work that, without any major changes, must be carried out

(Chritamara et al. 2001), preparing for its execution and helping to decide whether to continue with the project or not (Fageha and Aibinu 2013).

An incomplete scope definition, in the early stages of the life cycle of a project, is a common source of difficulties in the construction sector. In contrast (Fageha and Aibinu 2014), a complete scope definition guarantees a successful and problem-free application of the execution of the project.

Hence, one of the first steps in the project planning process is to understand what must be defined, with the aim of ensuring in advance that the scope is clear in relation to the different elements, which will facilitate the success of the project (Cho and Gibson 2001), achieving:

- Identification of what must be considered in the project definition
- Investigation of interrelationships
- Determination of the contributions to the general integrity of project definition

In summary, the project scope represents the first of its success criteria, thanks to its globalizing nature and predictive significance, as well as to its tactical importance when faced with changes. Thus, for an effective project management methodology, it is necessary to start by modelling a scope management system based on the proposals of the most important international project management organizations, such as PMI, IPMA and ISO, as shown in Fig. 1.

The individual competence baseline ICB 4 of IPMA (IPMA 2015) provides the necessary professional project management competencies, as they offer the capacity

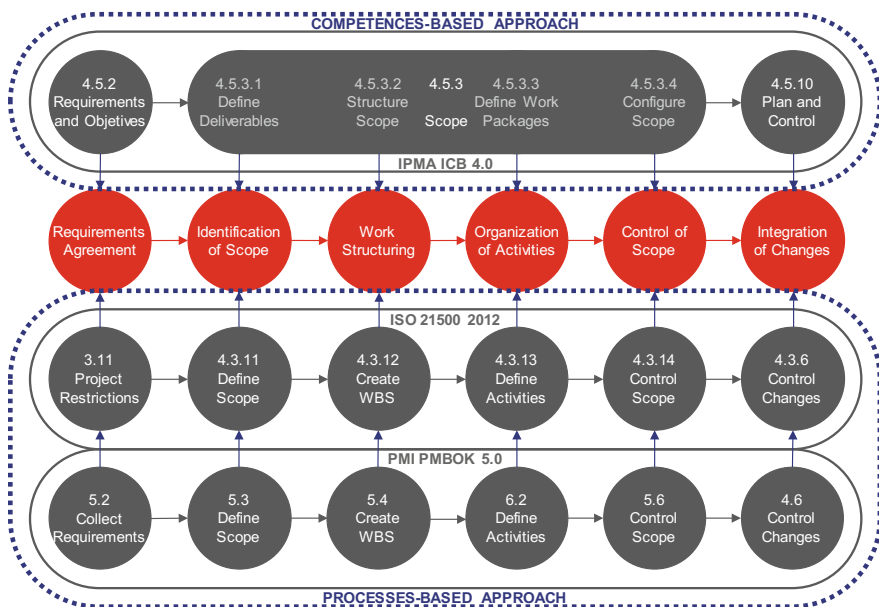


Fig. 1 Scope management model for construction projects

to integrate individual elements. Furthermore, the structure of the PMBOK 5 guide of PMI (PMI 2013) provides a reference framework to apply the system processes, tools and techniques.

Thus, based on the theories proposed by the most prestigious associations worldwide, both PMI -with its research programmes and development opportunities- and IPMA -with its humanist vision-, the theoretical model is aligned with the international standard ISO 21500 (ISO 2012), compatible, not only with PMI PMBOK and IPMA ICB, but also with Axelos PRINCE2, PMAJ P2M, ISO 10006, BS 6079, DIN 69901, ANSI 99-001 and AS 4915, among other benchmark standards.

### 3.2 Project Definition Rating Index -PDRI-

PDRI is a project management tool that helps to calculate a total score representing the level of project definition (Dumont et al. 1997).

There are three validated PDRI models that are each focused on a specific industry sector, for industrial, building and infrastructure projects.

For projects in the construction sector, PDRI is an exhaustive and weighted list of sixty-four elements for defining the scope of a project, which provides project teams and their managers with an objective assessment of the state of the project (Wang 2002).

PDRI is divided into three sections representing the three main stages of the project: viability, planning and execution, with their respective categories, as can be seen in Table 1, which includes the number of elements per section and/or category:

The use of this practice (Wang 2002) generates numerous benefits for the project, and by extension, for its stakeholders, among which must be noted that it:

- Measures the level of development of the project scope
- Identifies elements insufficiently defined, in order to take action
- Improves efficiency in time and cost management in the early stages of the project as it is used as a guide for defining objectives and scope

**Table 1** Sections and categories of PDRI

I. Basis of project decision	(16)	II. Basis of design	(32)	III. Execution approach	(14)
A. Business strategy	(06)	D. Site information	(08)	H. Procurement strategy	(02)
B. Owner philosophies	(04)	E. Project programming	(13)	J. Deliverables	(02)
C. Project requirements	(06)	F. Design parameters	(08)	K. Project control	(05)
		G. Equipment	(03)	L. Project execution plan	(05)

- Allows assessment and tracking of projects throughout their life cycle
- Predicts risk factors that could divert project performance
- Unifies criteria in the evaluation of the state, variance and progress of the project
- Creates an organizational culture for running mature and well-defined projects
- Improves alignment and communication in project management teams

In more detail, PDRI is a scoring tool to measure the adequacy of project scope definition, with the aim of improving complete scope definition: A low PDRI score represents good scope definition and, in general, corresponds to a greater probability that the project will be successful. In contrast, a high score means that certain elements of the scope are not adequately defined (Cho and Gibson 2001).

### 3.3 *Earned Value Management -EVM-*

EVM provides organizations with the methods required to integrate project scope management, schedule and budget, in response to questions that are critical for the success of the project (PMI 2011):

- Current status of the work, compared to planning
- Schedule for project completion
- Current real cost, compared to budget
- Cost of project completion

In general terms (Alsina 2013), EVM offers the following opportunities:

- To check whether the project is progressing over or within budget
- To check whether the project is progressing ahead of or behind schedule
- To observe project trends
- To make projections according to varying project status
- To take actions to mitigate the impact of any problems detected

Nevertheless, the most demanding and critical requirements in EVM are neither the cost nor the timeline of the project, but the total definition of its scope together with its structuring by means of the work breakdown structure -WBS- (Fleming and Koppelman 2010).

Furthermore, if it is rejected that, in construction projects, a schedule reduction implies, unequivocally, a reduction in indirect expenses and general costs, then it is essential to explain the inversely proportional relationship between the length of the project and its direct cost. In this context, the need arises to use a tool that connects these variables to each other and, in addition, to the project scope (Bustos 2014).

In the field of construction, this is a proactive method from the point of view of the project management team, based on compiling information to record the progress of the project and adopting a strategic approach that allows us to make predictions and take measures as a consequence (Valderrama and Guadalupe 2010).

To this end, EVM (PMI 2011) permits the tracking and control of the components of scope, time and cost, measuring:

- Performance, determining the budgeted cost of the work completed to date, also called earned value -EV-, and comparing it to the actual cost of the work completed -AC-
- Variance, comparing earned value -EV- with planned value -PV-

Below, based on the variables EV, PV and AC, are definitions of the indicators that allow to control project status in relation to approved budget and schedule at any time during its execution and not only at completion:

- $CPI = EV/AC$ , measures the efficiency of the use of resources of a project, aiming for values of  $\geq 1$ , reference forecast
- $SPI = EV/PV$ , measures the efficiency of the work and variance of the project, aiming for values of  $\geq 1$ , reference forecast
- $CSI = CPI \times SPI$ , measures how CPI and SPI compensate for each other

## 4 Case Study

In this present study, four construction projects are presented, two historical ones and two in which the management system described in point 3.1 has been implanted, in order to assess and compare their performance; validating both the system modelling and the use of the chosen predictive tools, PDRI and EVM.

The projects chosen, two industrial ones in the planning stage and two commercial ones in the execution stage were run in the same socioeconomic context, between the years 2011 and 2015, and in the same geographical context with all of them being located in the Cadiz town of El Puerto de Santa Maria. Likewise, they were run by the same project management team and have similar typological, technical and construction characteristics.

The projects and construction works selected are:

- Advanced Engineering Firm, as a historical project for contrasting purposes
- Industrial Business Park, as a medium-sized industrial project
- Wine bar, as a historical construction work for contrasting purposes
- Dermatology Clinic, as a small commercial construction work

Table 2 shows the specifications -site, size and completion dates- of the selected projects:



**Table 2** Technical specifications of the selected projects

Project/ Construction	Location	Total surface area (m <sup>2</sup> )	End of project	End of construction
Engineering Firm	Salinas Poniente IE	400	2012	2013
Business Park	Salinas Poniente IE	990	2013	Still underway
Wine Bar	Ribera del Rio St	70	2011	2012
Clinic	Vistahermosa Urb	120	2014	2015

## 5 Results

Below are the results obtained for the four selected projects from the indices provided by the predictive tools under study: PDRI and EVM.

Next, these results are contrasted in order to obtain, on one hand, approval of the management system model, and on the other hand, validation of the predictive tools used.

### 5.1 PDRI Results

In this section the results obtained from the four projects and construction works selected are analysed for the sixty-four indicators of the construction PDRI categories, in their three stages -viability, planning and execution.

As is explained by the Construction Industry Institute -CII-, the elements of the PDRI do not all have the same importance, with respect to their potential impact on the global success of the project (CII 1999). In order to increase their usefulness as risk analysis tools, their scores on the scale of satisfaction are not uniform, being weighted according to a statistical analysis of successful and failed projects in the sector.

The PDRI is obtained from the historical data available from the previous projects and the data recorded for those projects in which a system has been implanted, as can be seen in Table 3:

Figure 2 shows the results obtained for the four chosen projects, demonstrating how the management system succeeds in attaining scores below the target value and, therefore, keeps to the established objectives:

**Table 3** Technical specifications of the selected projects

Section	Level of definition				Section	Level of definition			
Element	IP1	IP2	CC1	CC2	Element	IP1	IP2	CC1	CC2
<i>I. Project viability</i>						136	52	105	48
A1. Building use	12	1	1	1	A2. Business justification	0	0	0	0
A3. Business plan	14	8	0	0	A4. Economic analysis	6	6	0	0
A5. Facility requirements	9	2	16	9	A6. Future expansion	1	1	1	1
A7. Site considerations	8	1	8	1	A8. Objectives statement	4	1	11	4
B1. Reliability philosophy	5	5	5	5	B2. Maintenance philosophy	5	1	9	1
B3. Operating philosophy	5	1	5	1	B4. Design philosophy	1	1	1	1
C1. Value-analysis process	10	6	14	6	C2. Design criteria	13	1	1	1
C3. Existing facilities	2	2	2	2	C4. Scope of work	5	1	5	1
C5. Schedule	15	6	11	6	C6. Cost estimate	21	8	15	8
<i>II. Project planning</i>						157	69	119	52
D1. Site layout	0	1	0	0	D2. Site surveys	8	1	0	0
D3. Geotechnics	19	2	0	0	D4. Legal requirements	1	1	1	1
D5. Environment	12	5	5	1	D6. Utility sources	4	1	7	1
D7. Site life safety	1	1	1	1	D8. Waste treatment	3	1	6	1
E1. Program statement	9	5	12	5	E2. Building summary list	16	6	21	6
E3. Adjacency diagrams	3	3	10	6	E4. Stacking diagrams	4	4	13	4
E5. Growth development	1	1	8	5	E6. Circulations	4	1	1	1
E7. Functional relationships	3	1	1	1	E8. Loading facilities	4	2	1	1
E9. Transport	7	7	1	1	E10. Building finishes	1	1	1	1
E11. Room data Sheets	7	4	4	1	E12. Equipment	4	1	1	1
E13. Window treatment	0	0	0	0	F1. Civil/site design	4	1	1	1
F2. Architectural design	1	1	1	1	F3. Structural design	1	1	0	0
F4. Mechanical design	6	2	0	0	F5. Electrical design	5	1	1	1

(continued)

**Table 3** (continued)

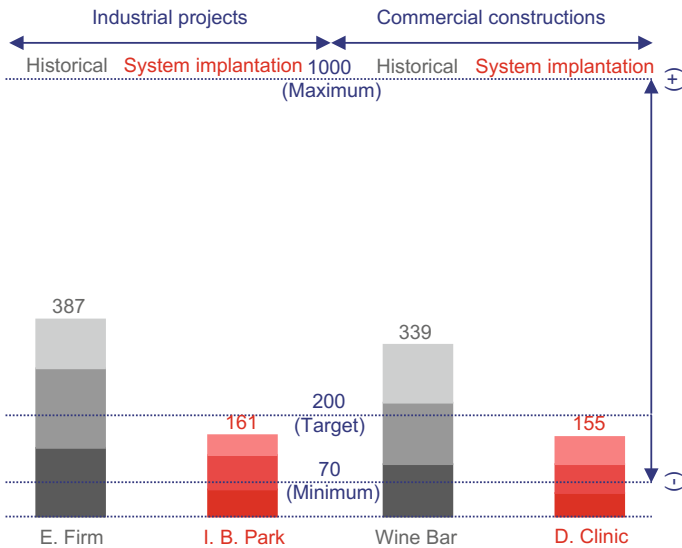
Section	Level of definition				Section	Level of definition			
Element	IP1	IP2	CC1	CC2	Element	IP1	IP2	CC1	CC2
F6. Building life safety	1	1	1	1	F7. Constructability	11	4	4	1
F8. Technology	5	3	5	3	G1. Equipment list	5	1	5	1
G2. Localization drawings	1	1	3	1	G3. Equipment utility	6	4	6	4
<i>III. Project execution</i>						94	40	115	55
H1. Materials	10	1	7	4	H2. Procurement procedures	9	3	11	3
J1. CADD/model	2	0	4	0	J2. Deliverables	2	1	7	2
K1. Quality control	3	1	3	1	K2. Cost control	7	4	7	4
K3. Schedule control	11	4	8	4	K4. Risk management	14	10	18	10
K5. Safety procedures	1	1	1	1	L1. Project organization	5	3	5	3
L2. Owner approval criteria	9	4	9	6	L3. Project delivery method	5	1	15	8
L4. Construction plan	11	4	11	4	L5. Substantial completion	5	3	9	5
<i>Total</i>						387	161	339	155

With: IP1 Industrial Project 1 (historical). Advanced Engineering Firm

IP2 Industrial Project 2. Industrial Business Park

CC1 Commercial Construction 1 (historical). Wine Bar

CC2 Commercial Construction 2. Dermatology Clinic



**Fig. 2** Results obtained in the PDRI for the selected projects

## 5.2 EVM Results

In this section, the results obtained for the four projects and construction works selected are analysed, in relation to keeping within planned budgets and timelines, using the EVM tool, based on historical data from the previous projects and the data available from the projects in which a system has been implanted.

Table 4 shows the percentage of the budget, planned and actual, for each first level of the work breakdown structure -WBS-, both for the industrial projects and for the commercial constructions:

Analogously to Tables 4, 5 shows the schedule percentage, planned y actual, for each first level of the work breakdown structure -WBS- of the projects and construction works chosen:

Based on data from the budgets and schedules of the chosen projects, the final EVM indicators are obtained, from their PV, AC and EV variance curves both in the planning stage, in the case of the industrial projects, and in the execution stage in the case of the commercial constructions, as shown in Fig. 3:

**Table 4** Planned and actual costs of the projects and construction works selected

WBS (level 1)	Budget (%)			
<i>Industrial projects</i>	Advanced engineering firm		Industrial business park	
	Planned (%)	Actual (%)	Planned (%)	Actual (%)
1. Report	12.50	16.10	12.50	12.66
2. Annexes to the report	20.00	25.80	20.00	20.28
3. Tender specifications	7.50	9.67	7.50	8.03
4. Measurements and budget	22.50	28.93	22.50	22.78
5. Drawings	37.50	44.30	37.50	38.25
<i>Total</i>	<i>100.00</i>	<i>128.80</i>	<i>100.00</i>	<i>102.00</i>
WBS (level 1)	Budget (%)			
<i>Commercial constructions</i>	Wine bar		Dermatology clinic	
	Planned (%)	Actual (%)	Planned (%)	Actual (%)
D. Demolitions	6.96	7.74	5.35	9.16
F. Facades	6.68	7.54	9.55	4.90
P. Partitions	14.71	16.64	12.44	17.19
I. Facilities	26.87	30.43	27.42	26.98
N. Insulation and waterproof	0.73	0.92	1.16	0.84
R. Coatings	27.96	31.66	28.28	28.56
S. Signage and equipment	9.43	10.66	12.16	9.08
G. Waste management	2.76	2.80	2.34	2.52
Y. Health and safety	3.90	3.90	1.30	1.99
<i>Total</i>	<i>100.00</i>	<i>112.29</i>	<i>100.00</i>	<i>101.22</i>

**Table 5** Planned and actual schedules of the projects and construction works selected

WBS (level 1)	Schedule (%)			
<i>Industrial projects</i>	Advanced engineering firm		Industrial business park	
	Planned (%)	Actual (%)	Planned (%)	Actual (%)
1. Report	10.00	15.00	12.50	12.25
2. Annexes to the report	20.00	25.00	18.75	18.25
3. Tender specifications	10.00	10.00	10.00	8.25
4. Measurements and budget	25.00	25.00	21.25	25.00
5. Drawings	35.00	45.00	37.50	31.25
<i>Total</i>	<i>100.00</i>	<i>120.00</i>	<i>100.00</i>	<i>95.00</i>
<i>Commercial constructions</i>	Wine bar		Dermatology clinic	
	Planned (%)	Actual (%)	Planned (%)	Actual (%)
D. Demolitions	30.00	40.00	10.00	20.00
F. Facades	30.00	30.00	20.00	30.00
P. Partitions	30.00	40.00	50.00	60.00
I. Facilities	60.00	50.00	50.00	40.00
N. Insulation and waterproof	20.00	10.00	30.00	30.00
R. Coatings	50.00	60.00	50.00	50.00
S. Signage and equipment	10.00	20.00	30.00	40.00
G. Waste management	100.00	100.00	70.00	80.00
Y. Health and safety	100.00	120.00	100.00	100.00
<i>Total</i>	<i>100.00</i>	<i>120.00</i>	<i>100.00</i>	<i>100.00</i>

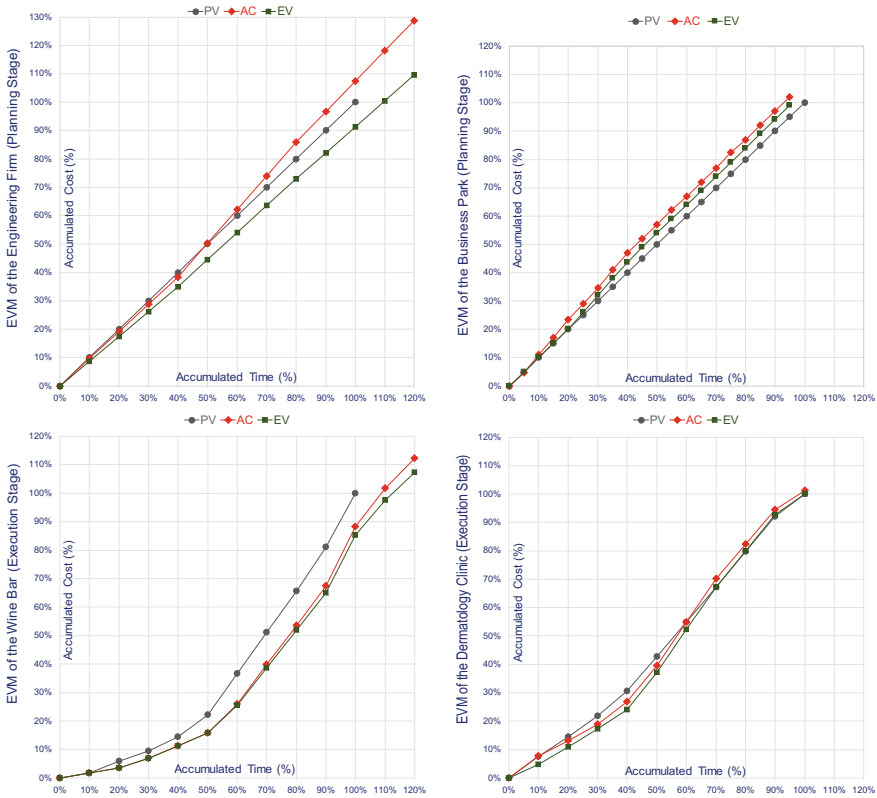
Table 6 shows the final EVM indicators:

### 5.3 Analysis of Results

In the case of the industrial project where the scope management system has been implanted -the industrial business park-, the PDRI was reduced by 58%; and in the case of the commercial construction -the dermatology clinic-, by 54%, with both

**Table 6** EVM analysis for the projects and construction works selected

<i>Type of industrial projects</i>		<i>CPI</i>	<i>SPI</i>	<i>CSI</i>
Historical	Advanced engineering firm	0.851	0.913	0.777
Management System implementation	Industrial business park	0.980	1.035	1.014
<i>Type of commercial constructions</i>		<i>CPI</i>	<i>SPI</i>	<i>CSI</i>
Historical	Wine Bar	0.956	0.852	0.815
Management System implementation	Dermatology clinic	0.988	1.000	0.988



**Fig. 3** EVM variance curves for the projects and construction works selected

cases achieving values of below the target value, thanks to the implications that scope management, reflected in the correct definition of the different parts of the projects, has on strategy, quality, budget and schedule of the projects (Cho and Gibson 2001), among other restrictions.

Likewise, in the case of the industrial project where the scope management system has been implanted, the CSI index of the EVM was increased by 31%; and in the case of the commercial construction, by 21%, in this last case achieving values even higher than the target, as it analyses the possibility of compensating for savings in the budget with delays in the schedule and vice versa, through the addition of resources, outsourcing of tasks, subcontracting of processes or parallelization of activities (Tello 2010).

From the results obtained from the predictive tools, PDRI and EVM, it can be deduced that scope management is the most important of the three restrictions that make up the hard nucleus of the project -together with cost and time- (Shenhar et al. 2001). As a consequence, the management model implanted is accepted and validated by the results shown in Table 7:

**Table 7** Results of the system implantation in terms of performance

<i>Planning stage (industrial types)</i>		<i>Δ Budget</i>	<i>Δ Schedule</i>
Before implantation	Advanced engineering firm	+29%	+20%
After implantation	Industrial business park	+01%	-04%
<i>Execution stage (commercial types)</i>		<i>Δ Budget</i>	<i>Δ Schedule</i>
Before implantation	Wine Bar	+15%	+20%
After implantation	Dermatology clinic	+01%	±00%

Thanks to the implantation of the management model proposed and using the control tools PDRI and EVM, budget overruns -between 15% and 30%- and delays -between 20% and 25%- caused by bad project definition are avoided.

## 6 Conclusions

Within organizations involved in construction projects, actions must be undertaken to minimize negative effects on the budget and timeline, hence adequate control of both is essential to guarantee the success of the project. Likewise, good scope management within a project provides the foundations necessary to allow us to act on the most relevant aspects to be taken into consideration to reduce the causes leading to bad performance in these areas.

By establishing optimum levels of project definition in the early stages, objective-focused practices are proposed which can intervene in those factors that attain management efficiency, aligning with the strategy, as a route to success.

The proposed system documents the competencies and processes necessary in order to carry out efficient and effective scope management, favouring the tracking of the project in all its stages, from its conception to its closure, raising awareness of the importance of defining the project and inspecting the variables that may hinder the achievement of the agreed objectives.

In the projects prior to the implantation of the system, the lack of scope definition in the planning and execution stages generates changes that have repercussions on performance. However, once the system is implanted, there is better project definition, which generates fewer changes caused by project deficiencies and; therefore, fewer contradictions, in addition to more realistic estimations.

As a consequence, the use of predictive tools during the running of the projects and not only at their conclusion, allows management teams to observe the variance and tendencies of the projects based on their status and progress, which means they can pre-empt by undertaking any corrective or preventive actions necessary.

## References

- Alsina J (2013) Gestión de valor ganado “EVM” para control de proyectos. In: Project charter. Available via <http://www.projectcharter.com>. Cited 15 Nov 2016
- Bustos O (2014) Factores latentes de la desviación de presupuestos en proyectos de arquitectura. Universitat Politècnica de València, Un análisis empírico. <https://doi.org/10.13140/RG.2.1.1214.4168>
- Camilleri E (2011) Project success: critical factors and behaviours. Gower Publishing Company, Burlington, NJ, USA
- Cho CS, Gibson GE (2001) Building project scope definition using project definition rating index. *J Architectural Eng* 7:115–125. [https://doi.org/10.1061/\(ASCE\)1076-0431\(2001\)7:4\(115\)](https://doi.org/10.1061/(ASCE)1076-0431(2001)7:4(115))
- Chritamara S, Ogunlana SO, Bach NL (2001) Investigating the effect of initial scope establishment on the performance of a project through system dynamics modelling. *Eng, Constr Architectural Manage* 8:381–392. <https://doi.org/10.1108/eb021198>
- Consejo Superior de los Colegios de Arquitectos de España -CSCAE- (2016) Estadística de la edificación: 4º trimestre 2015. In: Estadística de la edificación. Available via <https://www.cscae.com/index.php/es/servicios58/estadistica/informes36>. Cited 15 Nov 2016
- Construction Industry Institute -CII- (1999) RR155-11. Development of a project definition rating index (PDRI) for building projects. The University of Texas at Austin, TX, USA
- Davis K (2014) Different stakeholder groups and their perceptions of project success. *Int J Project Manage* 32:189–201. <https://doi.org/10.1016/j.ijproman.2013.02.006>
- Dumont PR, Gibson GE, Fish J (1997) Scope management using PDRI. *J Manage Eng* 13:54–60. [https://doi.org/10.1061/\(ASCE\)0742-597X\(1997\)13:5\(54\)](https://doi.org/10.1061/(ASCE)0742-597X(1997)13:5(54))
- Fageha MK, Aibinu AA (2013) Managing project scope definition to improve stakeholders’ participation and enhance project outcome. *Procedia – Soc Behav Sci* 74:154–164. <https://doi.org/10.1016/j.sbspro.2013.03.038>
- Fageha MK, Aibinu AA (2014) Prioritising Project scope definition elements in public building projects. *Australas J Constr Econ Build* 14:18–33. <https://doi.org/10.5130/ajceb.v14i3.4155>
- Fleming QW, Koppelman JM (2010) Earned value project management, 4th edn. Project Management Institute -PMI-, Newtown Square, PA, USA
- Fortune J, White D, Jugdev K, Walker D (2011) Looking again at current practice in project management. *Int J Managing Projects Bus* 4:553–572. <https://doi.org/10.1108/17538371111164010>
- Heywood C, Smith J (2006) Integrating stakeholders during community FM’s early project phases. *Facilities* 24:300–313. <https://doi.org/10.1108/02632770610666152>
- Instituto Nacional de Estadística -INE- (2016) Contabilidad nacional trimestral de España. 4º trimestre 2015. In: Sección Prensa. Available via [http://www.ine.es/prensa/seccion\\_prensa.htm](http://www.ine.es/prensa/seccion_prensa.htm). Cited 15 Nov 2016
- International Project Management Association -IPMA- (2015) Individual competence baseline for project, programme & portfolio management, 4th edn. International Project Management Association -IPMA-, Zurich, Switzerland
- International Organization for Standardization -ISO- (2012) ISO21500: guidance on project management. International Organization for Standardization -ISO-, Geneva, Switzerland
- KPMG (2015) Global construction survey 2015: Climbing the curve. In: *Informes y Tendencias*. Available via <https://home.kpmg.com/es/es/home/tendencias/2015/04/global-construction-survey-2015.html>. Cited 15 Nov 2016
- Project Management Institute -PMI- (2013) A guide to the project management body of knowledge -PMBOK-, 5th edn. Project Management Institute -PMI-, Newtown Square, PA, USA
- Project Management Institute -PMI- (2011) Practice standard for earned value management, 2nd edn. Project Management Institute -PMI-, Newtown Square, PA, USA
- Shenhar AJ, Dvir D, Levy O, Maltz AC (2001) Project success: a multidimensional strategic concept. *Long Range Plan* 34:699–725. [https://doi.org/10.1016/S0024-6301\(01\)00097-8](https://doi.org/10.1016/S0024-6301(01)00097-8)



- Subdirección General de Estudios Económicos y Estadísticas -SGEEE- (2016) Estructura de la construcción 2014. In: Publicaciones Anuales. Available via <http://www.fomento.es/NR/rdonlyres/1F17450D-9AE2-43D6-9C1B-EBA02F9413A7/136574/EC2014.pdf>. Cited 15 Nov 2016
- Tello E (2010) Valor ganado, una operativa a seguir para monitorear un proyecto. In: Proceedings of the Congress Tour PMI Cono Sur 2010. PMI-Buenos Aires Chapter, Mendoza, Argentina
- Valderrama FG, Guadalupe RE (2010) Dos modelos de aplicación del método EVM para el sector de la construcción. In: Proceedings of the 14th international congress on project engineering. Asociación Española de Dirección e Ingeniería de Proyectos -AEIPRO-, Madrid, Spain
- Wang Y (2002) Applying the PDRI in project risk management. The University of Texas at Austin, Tx, USA

# Expanding the Knowledge on Project Management Standards: A Look into the PMBOK® with Dynamic Lenses



V. Hermano and N. Martín-Cruz

**Abstract** Despite the large number of available project management standards and the efforts for improving its content and application, projects still fail. Researchers have identified that project management standards are generic and abstract and there is still the need to expand our knowledge in how to use them properly. The aim of this work is to develop an analytical principle-based approach for project management by highlighting which of the processes contained in the PMBOK® are suitable to manage projects in moderately dynamic environments. Results of the work shows that PMBOK® processes could be considered as micro-foundations of a project management dynamic capability.

**Keywords** Dynamic capabilities · Project success · Principle-based approach Routines

## 1 Introduction

The role projects play in modern organizations has shifted from sporadic endeavors intended to implement changes to widespread practice for developing a firm's daily work and implementing an overall strategy (Irja 2006). This “projectification” process has come along with the rise of a whole discipline, i.e. project management, dedicated to improve the management of projects. In this sense, one of the main focus of project management has been the development of tools and techniques that, gathered in what it is called project management (PM) standards, pretend to

---

V. Hermano (✉) · N. Martín-Cruz  
Department of Business and Marketing, University of Valladolid,  
Avenida Valle Esgueva, 6, 47011 Valladolid, Spain  
e-mail: victor.hermano@uva.es

N. Martín-Cruz  
e-mail: ambiela@eco.uva.es

© Springer International Publishing AG, part of Springer Nature 2019  
J. L. Ayuso Muñoz et al. (eds.), *Project Management and Engineering Research*,  
Lecture Notes in Management and Industrial Engineering,  
[https://doi.org/10.1007/978-3-319-92273-7\\_2](https://doi.org/10.1007/978-3-319-92273-7_2)

increase chances of success in projects, and also serve as a basis for the certification of professional project managers (Hällgren et al. 2012; Vaskimo 2013).

PM standards influence the practices of the project management community and represent an institutionalized collective identity of project managers worldwide (Morris 2012; Hällgren and Söderholm 2010). Moreover, they are expected to harmonize the terminology of the project management field and so reducing conflicts within the project team as well as with a project's stakeholders (Ahlemann et al. 2009). Therefore, PM standards are increasingly considered as an important building block in modern organizations (Ahlemann et al. 2009). In fact, there is a wide range of available PM standards developed by several national and international project management associations, e.g. the Project Management body of Knowledge -PMBOK®- developed by the Project Management Institute, the IPMA Competence Baseline -ICB- developed by the International Project Management Association, the Projects IN Controlled Environments -PRINCE2- developed by the Association for Project Management, etc.

However, despite the efforts for developing and improving the content of PM standards, projects still fail (Lehtonen and Martinsuo 2006). Furthermore, the explanation of the positive relationship between the use of PM standards and the success of projects is still missing both theoretically (Milosevic and Patanakul 2005) and empirically (Joslin and Müller 2015).

Among the different problems that researchers have identified in using PM standards (e.g. Ahlemann et al. 2009; Milosevic and Patanakul 2005; Joslin and Müller 2015; Hällgren et al. 2012) two of them have received greater attention. First, PM standards are generic and abstract (Hällgren et al. 2012; Ahlemann et al. 2009). Since PM standards cannot be unlimited and must fit every project, they only contain those aspects that are easy to codify, while the most challenging or specific ones are missing (Hällgren et al. 2012). Moreover, the PM standards only cover a part of the practice (that which can be written down in a formal document) and present ideal situations that, in the best case, only partially fit into reality (Hällgren et al. 2012). Therefore, PM standards can be considered as creations of a made-up world that fits every theoretical project but do not represent any real one (Hällgren et al. 2012). Second, PM standards suffer from a lack of flexibility and adaptability (Ahlemann et al. 2009). Most PM standards are based on an engineering approach where problems are fully specifiable and can be fully solved through optimal solutions (Dybå and Dingsøy 2008). Thus, PM standards contain predictable, fixed and relatively stable and simple models that allow project managers to specify the whole project management process into a project plan. However, today's projects are carried out in an extremely complex and turbulent environment (Shenhar and Dvir 2007), and so none of them can be specified as a linear sequence of operations (Styhre et al. 2010).

The problem of coping with a dynamic and uncertain environment affects not only the management of projects but the overall management of companies, and so it has been discussed by researchers in the field of strategic management.

Scholars posit that the time has come to broaden the traditional approach to strategic management and decision making with a new perspective founded on complexity science (Snowden and Boone 2007, 1). Managers cannot keep relying on approaches that work well just in a single set of circumstances, but they have to apply more flexible strategies (Snowden and Boone 2007). As an example of a flexible strategy, the Cynefin framework classifies the context into 5 categories based on the existence of cause-effect relationships and the possibility of achieving right decisions (Snowden and Boone 2007). Once managers sense which type of environment they are facing, they can choose an appropriate management style avoiding wrong decisions (Snowden and Boone 2007).

Regarding project management, practitioners have developed a new type of methodologies, i.e. agile methods, which instead of focusing on the development of a baseline plan, these agile methods assume customer satisfaction, continuous work deliver, welcome of changes, etc. as their principles (Beck et al. 2001). Moreover, scholars claim that there is a need to expand knowledge about how to use traditional PM standards by including instructions about which of their tools and methods are appropriate and relevant to each industry or project type (Hällgren et al. 2012). Furthermore, project management research needs a better foundation based on theoretical arguments that can be found in strategic management theories (Hällgren et al. 2012; Shenhar and Dvir 2007; Killen et al. 2012). In this sense, it is worth to mention the application of the dynamic capabilities approach for the treatment of uncertainty (Petit 2012), and for the achievement of project and portfolio performance (Biedenbach and Müller 2012; Killen et al. 2012; Petit and Hobbs 2010).

This article responds to the call for expanding the knowledge on PM standards. Specifically, the article seeks to take the first step for articulating a principle-based approach to project management that is applicable to a widely set of circumstances. Drawing on the dynamic capabilities approach, the aim of this work is to identify the elements of the PMBOK®, the world's leading PM standard (Ahlemann et al. 2009; Milosevic and Patanakul 2005), that are specially relevant for managing projects in moderately dynamic environments, where the introduction of new unknowns is constant as projects progress and there is the need for sensing emerging situations and allowing for plan reconfiguration (Styhre et al. 2010; Collyer and Warren 2009).

Section 2 starts with a review of the dynamic capabilities approach, the role and advancement of PM standards, and then an integrative framework of these two worlds is created. Section 3 identifies the elements of the PMBOK® that are relevant to manage dynamic projects by assessing how they deal with the roles and microfoundations of project dynamic capabilities. Finally, in Sect. 4, the main conclusions, managerial implications, limitations and the directions for future research are presented.

## 2 Theoretical Framework

### 2.1 *The Dynamic Capabilities Approach*

Frequently conceived as an extension of the resource-based view (Barney 1991; Peteraf 1993), the dynamic capabilities approach tries to answer why some organizations achieve abnormal results when performing in turbulent and dynamic environments (Teece et al. 1997; Zollo and Winter 2002; Eisenhardt and Martin 2000). First defined as “the firm’s ability to integrate, build and reconfigure internal and external competences to address rapidly changing environments”, dynamic capabilities are considered as the main source for achieving sustainable competitive advantages (Teece et al. 1997, 516; Teece 2009). Therefore, the dynamic capabilities approach positions itself as a feasible solution for the main problem of the resource-based view, which is no other than *its inherently static nature* (Priem and Butler 2001). Following the words of Di Stefano et al. (2010), there are three main papers building up the theoretical core of the dynamic capabilities framework; that is Teece et al. (1997), Eisenhardt and Martin (2000), and Zollo and Winter (2002). Despite of the fact that these three papers possess some differences, they can also be considered complementary in many respects. First, they offer a clear distinction between dynamic and ordinary capabilities. Second, dynamic capabilities imply change and evolution, and are the potential to do things (Easterby-Smith and Prieto 2008). Therefore, some authors claim that the real output of dynamic capabilities are the changes in ordinary capabilities (Winter 2003). Finally, learning is considered as a core element for building dynamic capabilities since the micro-foundations of the dynamic capabilities are the organizational routines and processes (Helfat and Peteraf 2003; Zollo and Winter 2002).

### 2.2 *The Role of PM Standards*

Throughout more than 60 years of project management as an independent discipline (Morris 2012), one of the most profuse research topics has been that of project success (Joslin and Müller 2015). Specifically, many papers have been written trying to properly identify what has been called critical success factors (CSFs) (e.g. Pinto and Slevin 1987; Fortune and White 2006). Thus, since companies’ effectiveness partially depends on their projects success (Milosevic and Patanakul 2005), PM standards have become an important element for modern organizations and their development and improvement have become one of the main concerns for academics, practitioners, and especially for professional associations. Much of the PM standards, which are also the most widely used, are labeled as plan-based, and follow an engineering-based approach where problems are considered predictable and fully specifiable, hence they can be solved with an optimal solution (Dybå and Dingsøy 2008). The benefits provided through the application of these plan-based

PM standards are helping in terminology harmonization, which facilitates communications, promoting the professionalization of the project management discipline, and enhancing project success (Collyer and Warren 2009).

However, the business environment is changing at an increasing pace and companies are increasingly implementing projects in dynamic and uncertain environments. Traditional plan-based PM standards suffer from several liabilities such as knowledge losing, demotivation of talented project team members and separation between strategy makers (top managers) and strategy implementers (project managers), when applied in dynamic environments (Levitt 2011). In fact, the management of projects in dynamic environments is considered as an unresolved project management issue.

From a theoretical point of view, scholars claim that while classic projects can be managed by following a traditional plan-based approach, projects developed in dynamic environments are better managed under a learning strategy that involves continuum scanning, problem solving and flexibility (Pich et al. 2002). Regarding project management practice, facing the challenges of managing projects in dynamic environments asks for the development of a new type of PM standard - agile methods- that rather than following the engineering plan-based approach, is founded on recurring activities such as feedback loops, interactive reviews and close customer contact (Stettina and Hörz 2015). However, agile methods cannot be considered the silver bullets for managing projects in dynamic environments. Scholars have identified several liabilities in the application of agile methods like the absence of theoretical support for their claims and application problems when the project team is large and their members work in several projects at same time (Dybå and Dingsøyr 2008).

### ***2.3 Theoretical Cross-Fertilization Between Dynamic Capabilities and Project Management***

In some recent studies, different aspects of the project management discipline have been addressed through the dynamic capabilities approach. Theoretically, the building of project dynamic capabilities inside organizations is conceived as a way to overcome the tensions of having a dual structure- both project-based and functional (Melkonian and Picq 2011). Davies and Brady (2000; 2004) claim that only those organizations capable of learning and building project dynamic capabilities would be able to overcome the dichotomy between a projects' short-term objectives and organizations' long-term goals. Empirically, Jugdev et al. (2007) study which of the project management assets support project dynamic capabilities formation. Petit (2012) assesses the role played by project dynamic capabilities when managing portfolios in turbulent environments. Biedenbach and Müller (2012) study how the components of project dynamic capabilities, absorptive, innovative

and adaptive capabilities, enhance the performance of projects, programs and portfolios in the pharmaceutical industry.

As the interest of this work lies in the elements of PM standards especially suitable for managing projects in dynamic and uncertain environments, a dynamic capabilities perspective of project management is conceptualized. Based on previous analyses, it is posited that project managers enhance the development of project dynamic capabilities if they consider the following principles (Petit and Hobbs 2010; Boh 2007; Brady and Davies 2004; Kujala et al. 2010):

- To identify potential changes in a project's scope and in stakeholders behavior.
- To establish action plans and decision-making protocols for the opportunities and threats previously identified within a project environment.
- To modify a project plan and to redesign project activities and project teams as the project proceeds.
- To document lessons learned and to communicate them to subsequent projects.

This principle-based approach for project management highlights that the building of project dynamic capabilities help facing the challenges of managing projects in dynamic and turbulent environments and achieving organizational success through multiple project implementation.

### 3 Identifying the Dynamic Elements of the PMBOK®

#### 3.1 Methodology

In order to take an initial step towards the operationalization of the principle-based approach for project management presented in Sect. 2.3 of the paper, the elements of a plan-based PM standard are identified that might help project managers to manage projects in moderately dynamic environments, i.e. complicated and complex environments. Specifically, the analytical concepts of the literature review performed in Sect. 2 of the paper have been applied on the practices proposed in the PMBOK®, *the global de facto standard for those engaged in project management* (Starkweather and Stevenson 2011, p. 31). First developed as a white paper in 1983, the PMBOK® is a formal document that describes norms, methods, processes and practices generally recognized as good practices by project management professionals (Project Management Institute 2008; Eskerod and Huemann 2013). Moreover, the PMBOK® has been accepted as a standard by the American National Standards Institute and is used globally as a basis for managing projects and certified professionals (Hällgren et al. 2012).

Several papers have referred to PMBOK® for assessing how much their theoretical findings are in agreement with the practices in project management (Milosevic and Patanakul 2005; Hällgren et al. 2012; Eskerod and Huemann 2013; Collyer and Warren 2009). Specifically, for the purpose of this paper the PMBOK®

content is examined in an attempt to determine which of its sections and specific processes might be especially suitable for performing the three roles of dynamic capabilities builders (Teece et al. 1997) and the routines that constitute the microfoundations of project dynamic capabilities (Teece 2009). Moreover, disciplines such as accounting (Carmona and Trombetta 2008) or environmental regulation (Gunningham and Sinclair 1999) have built a principle-based approach by analyzing the available tools and standards, harnessing the strengths of each individual instrument while compensating for their individual weaknesses.

### 3.2 *Performing Dynamic Capabilities’ Roles Through PMBOK® Application*

In their seminal paper, Teece et al. (1997) establish three different roles top managers should perform to develop dynamic capabilities within their firms: coordination/integration, learning, and reconfiguration/transformation (Teece et al. 1997). In this work, the PMBOK®’s content is studied to appoint to the sections and processes especially relevant for performing these roles. Moreover, Table 1 shows in greater detail, different examples and specific sections of the PMBOK® that represent how project managers might perform each of the three roles.

**Table 1** The three roles performed by dynamic capabilities builders through PMBOK® content

Dynamic capabilities roles	PMBOK®’s areas and activities that might allow project managers to perform the three roles
Coordination/Integration role Tasks managers perform for coordinating and integrating activities inside the firm and also for the coordination of external activities and technologies (Teece et al. 1997, p. 518)	Chap. 4 is dedicated to project integration management and it includes the processes and activities needed to identify, define, combine, unify and coordinate the various processes and project management activities within the PM Process Group. Moreover, project integration management includes the activities aimed at ensuring the consistency of project documents, project plans and product deliverables.  The PMBOK® (p. 72) includes an example of a situation where project managers need to perform the coordination/integration role: A cost estimate needed for a contingency plan involves integrating the processes in the cost, time, and risk knowledge areas. When additional risks associated with various staffing alternatives are identified, then one or more of those processes may be revisited. The project deliverables may also need to be integrated with ongoing operations of either the performing organization or the customers’ organization

(continued)



**Table 1** (continued)

<p>Dynamic capabilities roles</p>	<p>PMBOK®’s areas and activities that might allow project managers to perform the three roles</p>
<p>Learning role                  Process by which repetition and experimentation enable tasks to be performed better and quicker (Teece et al. 1997, p. 520).</p>	<p>The concept of learning is pervasive in PMBOK®’s content and it is represented by the lessons learned term, which appears 56 times. The concept of lessons learned is defined in Sect. 2.4.3 where the different knowledge bases of a project are explained. The task of documenting and applying lessons learned is especially relevant during the closing phase (Sect. 4.6), where the PMBOK® talks about the importance of the historical information, when performing quality management, and finally, when developing the communications plan, where lessons learned of past projects might be used for guiding the planning of communication activities of the current project</p>
<p>Reconfiguration/Transformation role                  Refers to the need to reconfigure the organizational asset structure to address environmental changes (Teece et al. 1997, p. 520).</p>	<p>PMBOK® establishes change requests as an output for almost all of its 42 processes. Furthermore, PMBOK® advises project managers to perform the task-integrated change control that is explained in Sects. 3.6 and 4.5. The PMBOK® emphasizes the importance of change requests when describing how to direct and manage project execution. Specifically, it talks about approving change requests as an important part of the process of integrated change control: approved change requests are scheduled for implementation by the project team. Approved change requests are the documented, authorized changes to expand or reduce a project’s scope. The approved change requests can also modify policies, the project management plan, procedures, costs, or budgets, or revise schedules. Approved change requests may require implementation of preventive or corrective actions (Sect. 4.3.1)</p>

The coordination/integration role entails the project management routines performed to coordinate activities both within and outside the firm boundaries (Teece et al. 1997, p. 518). PMBOK®’s chapter four covers and discusses what it is called *project integration management* where the integration role is defined as *the processes and activities needed to identify, define, combine, unify and coordinate the various processes and project management activities within the PM Process Group* (Project Management Institute 2008, p. 71). *Project integration management entails making choices about resource allocation, making trade-offs among competitive objectives and alternatives, and managing the interdependences among the project management knowledge areas* (Project Management Institute 2008, p. 71).

Moreover, project integration management includes those activities aimed at ensuring the consistency of project documents, project plans and product deliverables. Regarding the second role, learning, it is defined as a process by which repetition and experimentation enable tasks to be performed better and quicker (Teece et al. 1997, p. 520). Through the learning role, managers sense dysfunctional routines and avoid strategic blind spots (Teece et al. 1997, p. 520). The learning role is pervasive in the PMBOK®. The PMBOK® includes a routine called *document lessons learned* as a component of the closing process group (Project Management Institute 2008). The concept of lessons learned appears 56 times and it is especially relevant during the closing phase of the project (Sect. 4.6), and when performing project quality management (Sect. 8.3.3) and developing the communications plan (Sect. 10.2). Finally, the reconfiguration/transformation role implies the reconfiguration and update of organizational routines and asset endowment, so environmental changes are addressed (Teece et al. 1997, p. 520). PMBOK® advocates to perform what it is called *change requests* as an output of almost all of its 42 processes. These change requests consist in the changes that should be introduced in project activities, or documents. These changes are sensed by the project team during the life of a project. Moreover, PMBOK® also asks project managers to perform the task called *integrated changed control* (Sects. 3.6 and 4.5). *Integrated changed control* consists on reviewing all change requests, and deciding for any request whether the proposed change has to be made or not (Project Management Institute 2008).

### **3.3 PMBOK® Processes and Outputs as Microfoundations for Dynamic Capabilities**

Project dynamic capabilities lead to achieve project performance under conditions of uncertainty and changes in client needs. Project dynamic capabilities are defined as those routines and processes that allow project teams to detect project opportunities and threats, and to establish and execute decision-making protocols for exploiting these opportunities and defend against these threats. In order to operationalize project dynamic capabilities, Teece's model (2009) is applied, in which dynamic capabilities disaggregate into three different sets of routines: routines to sense opportunities and threats, routines to seize opportunities, and routines to maintain competitiveness by reconfiguring organizational capabilities. As Table 2 shows, the application of some of the processes described in the PMBOK®, mainly those related to monitoring and controlling, generates outputs that might be considered as microfoundations for project dynamic capabilities.

Project sensing routines comprise routines aimed to identify potential changes in a project's scope, to assess stakeholders' behavior and to sense changes in the project environment (Aaltonen and Kujala 2010; Hermano 2013). An updated version of risk management principles claims that despite planning activities are

**Table 2** PMBOK® processes, activities and outputs as microfoundations of project dynamic capabilities

PMBOK® processes (sections they are contained in)	PMBOK® activities and outputs
Monitor and control project work (3.6.1 and 4.4) Process of tracking, reviewing and regulating the progress to meet the performance objectives defined in the PM plan	Sensing: comparing actual project performance against the plan Seizing: change requests Transforming: updates in PM plan and documents
Perform integrated change control (3.6.2 and 4.5) Process of reviewing all change requests, approving changes, and managing changes to the deliverables, organizational process assets and PM plan	Sensing: - Seizing: reviewing all change requests and approving changes Transforming: managing the approve changes/ updates in PM plan and documents
Verify scope (3.6.3 and 5.4) Process of formalizing acceptance of the completed project deliverables	Sensing: measuring and verifying to determine whether work and deliverables meet requirements Seizing: change request Transforming: updates in PM documents
Control Scope (3.6.4 and 5.5) Process of monitoring the status of the project and product scope and managing changes to the scope baseline	Sensing: work performance measurements Seizing: change requests Transforming: updates in organizational process assets, scope baselines, and in the traceability matrix
Control Schedule (3.6.5 and 6.6) Process of monitoring the status of the project to update project progress and manage changes to the schedule baseline	Sensing: work performance measurements (schedule performance index) Seizing: change requests Transforming: updates in organizational process assets, schedule baseline, and schedule data
Control Costs (3.6.6 and 7.3) Process of monitoring the status of the project to update the project’s budget and managing changes to the cost baseline	Sensing: work performance measurements (cost performance index, budget forecasts) Seizing: change requests Transforming: updates in organizational process assets, cost performance baseline, and costs estimates
Perform Quality Control (3.6.7 and 8.3) The process of monitoring and recording results from executing the quality activities in order to assess performance and recommended necessary changes	Sensing: - Seizing: validate changes and deliverables Transforming: updates in quality management plan and process improvement plan
Manage Stakeholders Expectations (5.2.3) Process of communicating and working with stakeholders to meet their needs and addressing issues as they occur	Sensing: identifying concerns that have not become issues yet Seizing: clarifying and resolving issues that have been identified Transforming: updates in stakeholder management strategy, stakeholder register and issue log
Risk Management (Chap. 11) The objective of risk management is to increase the probability and impact of positive events, and decrease the probability and impact of negative effects	Sensing: Identify risks Seizing: Perform both qualitative and quantitative risk analysis; Plan risks responses Transforming: Implementing risks response plans

necessary, there are constraints that cannot be taken into consideration at an early stage (Perminova et al. 2008). Therefore, project managers should scan the project environment during the whole project's life in order to detect uncertainties that could affect the project, both negatively and positively, and may imply changes in a project's scope and plans (Hermano 2013; Pollack 2007).

Besides, the role and influence of stakeholders over project performance is being increasingly studied (Eskerod and Huemann 2013). The sensing of environmental changes must be complemented through the study of stakeholders' behavior, with special attention to their ability to redefine project scope, and project performance (Hermano 2013; Petit and Hobbs 2010). Therefore, by developing sensing routines, project plans become flexible enough to allow for revisions and the incorporation of new ideas, improving their accuracy and suitability with the project dynamic environment (Pollack 2007; Petit and Hobbs 2010). As depicted in Table 2, monitoring and controlling processes (Sects. 3.6.1 and 4.4) described in the PMBOK® capture the essence of sensing routines since they urge project managers to evaluate the progress of the project in an attempt to identify possible deviations and environmental changes.

Project seizing routines are the structures, procedures, designs, and incentives for identifying changes required once an opportunity or threat is sensed (Teece 2009). By developing project seizing routines, project managers evaluate the influence of changes previously sensed over project content and project management decision-making process. Thus, project seizing routines imply establishing action plans for all the opportunities and threats previously sensed in each project (Hermano 2013). First, project managers determine how the opportunities and threats previously sensed would affect project content, and then, decision-making protocols and governance rules must be established to determine the changes that are actually going to be undertaken (e.g. if several changes in customers' needs have been sensed, project managers should establish decision-making protocols determining which of those customers' needs are aligned with the organization's business model and thus, have to be addressed). Seizing routines might be contained into the PMBOK® group of processes named *performing integrated change control* by which project managers review and evaluate the changes requests made due to environmental changes previously sensed (see Table 2).

Finally, project transforming routines imply managing threats and reconfiguration (Teece 2009). When competing in dynamic environments, firms have to address environmental shifts if they want to maintain their competitive advantage. (Teece 2009).

Reconfiguration routines imply the execution of the action plans previously designed for facing environmental shifts previously sensed (Petit 2012). Moreover, by performing reconfiguration routines, project managers modify the project plan and redesign project activities and even the project team (Hermano 2013). Therefore, by developing reconfiguration routines, project managers achieve semi-continuous projects' asset orchestration and PM processes renewal (Teece 2009).

As Table 2 shows, the PMBOK® provides several processes for updating project plan and documents during a project's life-cycle that might be considered as project transforming routines. Moreover, the PMBOK® assumes the need for reconfiguration by establishing the *rolling wave of planning* and *progressive elaboration* as guidelines when developing project plans. Both the rolling wave of planning and progressive elaboration establish a policy where the project plan is not fully developed but only outlined during project initiation and is then developed in greater detail as the project progresses (Collyer and Warren 2009).

## 4 Conclusions, Limitations, and Direction for Future Research

In an empirical study on innovation projects from a major multinational pharmaceutical company, Styhre et al. (2010, 134) state that “no [project] can be fully self-enclosed and rendered as a linear sequence of operations, but there is always a need for recognizing emergent properties of the system and to allow for some deviance from the prescribed procedures.” Thus, in order to manage projects in dynamic and uncertain environments, we have to “expand knowledge of how standards are used” (Hällgren et al. 2012, p. 480).

Drawing on the dynamic capabilities approach, this paper takes an initial step towards a principle-based methodology for project management by identifying the PMBOK® sections and processes that might be especially suitable for managing projects in moderately dynamic environments. Exploring PM standards through a dynamic capabilities lens, might enable development of both strategies and tools to assist project managers when managing projects in dynamic environments, where traditional plan-based standards have been claimed as not suitable or even counterproductive (Koskela and Howell 2002). As an initial step in this direction, this paper maps the fundamental concepts of dynamic capabilities contained in PMBOK®'s content. Mapping the fundamental concepts of the dynamic capabilities approach to the project management processes is the first step in the development of a framework that synthesizes the dynamic capabilities and project management literature.

Furthermore, as many scholars highlight, the application of strategic management theories to the study of projects and project management is highly potential (Grundy 1998; Killen et al. 2012). Specifically, the implications of this PMBOK® revision are threefold. First, we respond to the need to determine which processes and project management methods are appropriate for managing projects in dynamic and uncertain environments (Ahlemann et al. 2009, 294; Collyer and Warren 2009). The specific features of projects developed in dynamic environments drive project managers to abandon methods based on the plan-based approach turning towards learning strategies based on problem scanning and flexibility (Pich et al. 2002).

This paper shows which of the sections and processes of the PMBOK® are especially relevant to develop that learning strategy.

Second, the cross-fertilization among project management and dynamic capabilities approach provides the project management discipline with a strong theoretical framework. The lack of stable theoretical foundations is recognized as one of the most important obstacles for the project management progress (Koskela and Howell 2002; Pollack 2007). Thus, by applying the dynamic capabilities approach to project management, we strengthen the incipient theoretical framework, helping project management discipline to understand its main assumptions. The dynamic capabilities approach might shed light into project management problems, the root cause of which is managerial rather than technical (Koskela and Howell 2002; Kharbanda and Pinto 1996). Specifically, recent studies claim that project management should focus on managerial aspects instead of technical ones (Sausser et al. 2009; Shore 2008; Shepherd et al. 2011).

Finally, this paper provides several implications for project management professionals. On the one hand, project managers should not be slaves of project plans (Hermano 2013). Although planning is necessary, some constraints cannot be sensed at an early stage. Thus, project plans need to be flexible enough to allow for modifications as a project proceeds (Hermano 2013). Project managers need to continuously scan project environment in a search for uncertainties that could affect the project, both negatively and positively. On the other hand, project managers should understand that PM standards are not a panacea that automatically leads to project success, but they have to be interpreted and adapted to the specific features of each project.

Two different limitations can be identified in this paper. First, the analysis made is based on secondary data since PMBOK® was used as the only document in this study. Thus, it cannot be assured that the PMBOK® content represents the project management practices carried out by project management professionals. However, PMBOK® is considered the world's leading standard and it is used as a basis for the certification of project management professionals, hence, it is assumed that many people have studied it, and therefore, its prescriptions and processes are known. Second, although the sections and processes of the PMBOK® especially suitable for managing projects in moderately dynamic environments have been identified, its overall philosophy focuses on bringing activities in line with a plan which ultimately may lead to project failure in turbulent and dynamic environments (Collyer and Warren 2009). Therefore, the majority of the sections and processes of the PMBOK® might hamper the building of project dynamic capabilities, hence shattering the benefits of the dynamic elements previously identified.

It is suggested that future research on the topic should advance the development of the project management principle-based approach by continuing with the strategy of harnessing the strengths of each PM standard. The dynamic review of the PMBOK® should be replicated for all available PM standards in a search for the processes and routines that foster project dynamic capabilities building. Secondly, future studies should include both empirical and case studies where the actual practices developed by project management professionals are analyzed.

Furthermore, the study of project dynamic capabilities could be extended to the portfolio and the overall firm level.

## References

- Aaltonen K, Kujala J (2010) A project lifecycle perspective on stakeholder influence strategies in global projects. *Scand J Manag* 26(4):381–397
- Ahlemann F, Teuteberg F, Vogelsang K (2009) Project management standards–Diffusion and application in Germany and Switzerland. *Int J Project Manage* 27(3):292–303
- Barney J (1991) Firm resources and sustained competitive advantage. *J Manag* 17(1):99–120
- Beck K, Beedle M, Van Bennekum A, Cockburn A, Cunningham W, Fowler M, Jeffries R (2001) Manifesto for agile software development. The Agile Alliance, 2002–2004
- Biedenbach T, Müller R (2012) Absorptive, innovative and adaptive capabilities and their impact on project and project portfolio performance. *Int J Project Manage* 30(5):621–635. <https://doi.org/10.1016/j.ijproman.2012.01.016>
- Boh WF (2007) Mechanisms for sharing knowledge in project-based organizations. *Inf Organ* 17(1):27–58. <https://doi.org/10.1016/j.infoandorg.2006.10.001>
- Brady T, Davies A (2004) Building project capabilities: From exploratory to exploitative learning. *Organ Stud* 25(9):1601–1621
- Carmona S, Trombetta M (2008) On the global acceptance of IAS/IFRS accounting standards: the logic and implications of the principles-based system. *J Account Public Pol* 27(6):455–461
- Collyer S, Warren CMJ (2009) Project management approaches for dynamic environments. *Int J Project Manage* 27(4):355–364
- Davies A, Brady T (2000) Organisational capabilities and learning in complex product systems: Towards repeatable solutions. *Res Policy* 29(7–8):931–953
- Di Stefano G, Peteraf M, Verona G (2010) Dynamic capabilities deconstructed: a bibliographic investigation into the origins, development, and future directions of the research domain. *Ind Corp Change* 19(4):1187–1204
- Dybå T, Dingsøy T (2008) Empirical studies of agile software development: a systematic review. *Inf Softw Technol* 50(9):833–859
- Easterby-Smith M, Prieto IM (2008) Dynamic capabilities and knowledge management: an integrative role for learning?\*. *Br J Manag* 19(3):235–249. <https://doi.org/10.1111/j.1467-8551.2007.00543.x>
- Eisenhardt KM, Martin JA (2000) Dynamic capabilities: what are they? *Strateg Manag J* 21(10–11):1105–1121
- Eskerod P, Huemann M (2013) Sustainable development and project stakeholder management: What standards say. *Int J Manag Projects Bus* 6(1):36–50
- Fortune J, White D (2006) Framing of project critical success factors by a systems model. *Int J Project Manage* 24(1):53–65
- Grundy T (1998) Strategy implementation and project management. *Int J Project Manage* 16(1): 43–50. [https://doi.org/10.1016/S0263-7863\(97\)00016-1](https://doi.org/10.1016/S0263-7863(97)00016-1)
- Gunningham N, Sinclair D (1999) Integrative regulation: a principle-based approach to environmental policy. *Law Soc Inq* 24(4):853–896
- Hällgren M, Lindahl M, Hällgren M, Nilsson A, Blomquist T, Söderholm A (2012) Relevance lost! A critical review of project management standardisation. *Int J Manag Projects Bus* 5(3): 457–485
- Hällgren M, Söderholm A (2010) Orchestrating deviations in global projects: Projects-as-practice observations. *Scand J Manag* 26(4):352–367
- Helfat CE, Peteraf MA (2003) The dynamic resource-based view: capability lifecycles. *Strateg Manag J* 24(10):997–1010

- Hermano V (2013) The Project-Based firm as a new organization form: a dynamic capabilities approach (Doctoral dissertation). Retrieved from UVa Repositorio Documental (Accession No. b1674432)
- Irja H (2006) Project management effectiveness in project-oriented business organizations. *Int J Project Manage* 24(3):216–225
- Joslin R, Müller R (2015) Relationships between a project management methodology and project success in different project governance contexts. *Int J Project Manage* 33(6):1377–1392
- Jugdev K, Mathur G, Fung TS (2007) Project management assets and their relationship with the project management capability of the firm. *Int J Project Manage* 25(6):560–568. <https://doi.org/10.1016/j.ijproman.2007.01.009>
- Kharbanda OP, Pinto JK (1996) What made gertie gallop?: lessons from project failures. Van Nostrand Reinhold, New York
- Killen CP, Jugdev K, Drouin N, Petit Y (2012) Advancing project and portfolio management research: Applying strategic management theories. *Int J Project Manage* 30(5):525–538. <https://doi.org/10.1016/j.ijproman.2011.12.004>
- Koskela L, Howell G (2002) The underlying theory of project management is obsolete. *Proceedings of the PMI research conference* 293–302
- Kujala S, Arto K, Aaltonen P, Turkulainen V (2010) Business models in project-based firms – towards a typology of solution-specific business models. *Int J Project Manage* 28(2):96–106. <https://doi.org/10.1016/j.ijproman.2009.08.008>
- Lehtonen P, Martinsuo M (2006) Three ways to fail in project management and the role of project management methodology. *Project Perspect* 1:6–11
- Levitt RE (2011) Towards project management 2.0. *Eng Project Organ J* 1(3):197–210
- Melkonian T, Picq T (2011) Building project capabilities in PBOs: lessons from the French special forces. *Int J Project Manage* 29(4):455–467
- Milosevic D, Patanakul P (2005) Standardized project management may increase development projects success. *Int J Project Manage* 23(3):181–192
- Morris PW (2012) A brief history of project management. In: *The oxford handbook of project management*, 15–37. OUP Oxford
- Perminova O, Gustafsson M, Wikström K (2008) Defining uncertainty in projects – a new perspective. *Int J Project Manage* 26(1):73–79
- Peteraf MA (1993) The cornerstones of competitive advantage: a resource-based view. *Strateg Manag J* 14(3):179–191
- Petit Y, Hobbs B (2010) Project portfolios in dynamic environments: Sources of uncertainty and sensing mechanisms. *Project Manage J* 41(4):46–58
- Petit Y (2012) Project portfolios in dynamic environments: organizing for uncertainty. *Int J Project Manage* 30(5):539–553
- Pich MT, Loch CH, De Meyer A (2002) On uncertainty, ambiguity, and complexity in project management. *Manage Sci* 48(8):1008–1023
- Pinto JK, Slevin DP (1987) Critical factors in successful project implementation. *IEEE Trans Eng Manage* 1:22–27
- Pollack J (2007) The changing paradigms of project management. *Int J Project Manage* 25(3): 266–274. <https://doi.org/10.1016/j.ijproman.2006.08.002>
- Priem RL, Butler JE (2001) Is the resource-based” view” a useful perspective for strategic management research? *Acad Manag Rev* 26(1):22–40
- Project Management Institute (2008) *A guide to the project management body of knowledge*, 4th edn. Project Management Institute, USA
- Sausser BJ, Reilly RR, Shenhar AJ (2009) Why projects fail? how contingency theory can provide new insights – A comparative analysis of NASA’s mars climate orbiter loss. *Int J Project Manage* 27(7):665–679
- Shenhar AJ, Dvir D (2007) *Reinventing project management: The diamond approach to successful growth and innovation*. Harvard Business Review Press, Boston
- Shepherd DA, Patzelt H, Wolfe M (2011) Moving forward from project failure: negative emotions, affective commitment, and learning from the experience. *Acad Manag J* 54(6):1229–1259



- Shore B (2008) Systematic biases and culture in project failures. *Project Manage J* 39(4):5–16. <https://doi.org/10.1002/pmj.20082>
- Snowden DJ, Boone ME (2007) A leader's framework for decision making. *Harvard Bus Rev* 85(11):68–76
- Starkweather JA, Stevenson DH (2011) PMP® certification as a core competency: Necessary but not sufficient. *Project Manage J* 42(1):31–41
- Stettina CJ, Hörz J (2015) Agile portfolio management: an empirical perspective on the practice in use. *Int J Project Manage* 33(1):140–152
- Styhre A, Wikmalm L, Olilla S, Roth J (2010) Garbage-can decision making and the accommodation of uncertainty in new drug development work. *Creativity Innov Manage* 19(2): 134–146. <https://doi.org/10.1111/j.1467-8691.2010.00551.x>
- Teece DJ (2009) *Dynamic capabilities and strategic management: organizing for innovation and growth*. Oxford University Press, USA
- Teece DJ, Pisano G, Shuen A (1997) Dynamic capabilities and strategic management. *Strateg Manag J* 18(7):509–533
- Vaskimo A (2013) *Project management methodologies: an invitation for research*. Project Perspect, IPMA
- Winter SG (2003) Understanding dynamic capabilities. *Strateg Manag J* 24(10):991–995. <https://doi.org/10.1002/smj.318>
- Zollo M, Winter SG (2002) Deliberate learning and the evolution of dynamic capabilities. *Organ Sci* 13(3):339–351

# Lean Thinking: A Useful Tool to Integrate Sustainability into Project Management



C. Cruz-Villazon, J. R. Otegi-Olaso, M. E. Aguilar-Fernandez and L. Fuentes-Ardeo

**Keywords** Lean thinking · Sustainability · Project management  
Lean project management

## 1 Introduction

Lean Thinking (LT) was first introduced in the Toyota Production System in 1970 (Hines et al. 2004), and it became popular in 1990 following the publication of Womack's, Jones' and Roos' book "The Machine that Changed the World" (Anholon and Sano 2016). The approach has been shown to be a significant success, resulting in its worldwide implementation across a range of sectors, including products and services (Folinas et al. 2013). Womack and Jones (1996) state that LT philosophy is based on "improvement of continuous flow manufacturing, customer-driven production, waste elimination, zero defects, visual management, safe and orderly working environment, the elimination of non-value adding but cost incurring activities, and customer value" (as cited in Anholon and Sano 2016).

LT is viewed from two standpoints that are closely related. In their study, Bortolotti et al. (2015) link the work of Womack and Jones (1996) to a strategic/philosophical perspective, whilst the work of Shah (2003), Shah and Ward (2007) is linked to an operational/technical perspective. Hines et al. (2004) explain that the strategic level refers to value creation and understanding of customer value, whilst the operational level is concerned with improved efficiency and cost reductions.

LT has undergone substantial development in recent decades, which, as a result, has led to great changes in its targets, scope, and techniques for implementation (Hines et al. 2004). The success of LT in manufacturing has prompted other sectors to adopt this philosophy (Hines et al. 2004). Additionally, LT methods and

---

C. Cruz-Villazon (✉) · J. R. Otegi-Olaso · M. E. Aguilar-Fernandez · L. Fuentes-Ardeo  
Departamento de Expresión Gráfica y Proyectos de Ingeniería Escuela Técnica  
Superior de Ingeniería de Bilbao, Universidad del País Vasco (UPV/EHU),  
Alameda Urquijo, S/N, 48013 Bilbao, Spain  
e-mail: ccruz003@ikasle.ehu.eus

mind-sets are being applied in areas outside shop-floor operations (Hines et al. 2004). Aziz (2012) asserts that this philosophy can be extended to Project Management (PM), yet this is still rarely mentioned in the literature. Reusch and Reusch (2013) states that “lean management is a management of values” and it can be applied to improve project management.

In the 1990s, the first investigations emerged with regard to the link between LT and the three aspects of sustainability, but these were mainly conducted through observational case studies (Chianiri 2014). LT, environmental and social practices, as well as their effects on different aspects of the company’s performance have been studied separately (Galeazzo et al. (2014); Wu et al. 2015). Wu et al. (2015), establish that from a sustainability perspective, there is a need to collectively take into account these practices in order to have a more comprehensive framework.

## 2 Methodology

A literature review was conducted to identify the main ideas underlying the links between LT, PM and sustainability. Papers published in peer-reviewed journals and proceedings from the year 2000 up to 2016 were selected (except for Womack’s, Jones’ and Roos’ book “The machine that changed the world” (1990) and “Lean Thinking” (1996). Relevant books, reports, and theses were included. The survey was made using the following major research databases: Scopus, EBSCO, Web of Science and Google Scholar. A search of the literature was conducted by combining the following keywords: “Lean Thinking”, “Lean Thinking Project Management”, “Lean Project Management”, “Lean Sustainability”, “Green Lean”, “Lean environmental” and “Lean Project Management Sustainability”. Articles containing “Sustainable” where the word refers to “capable of being sustained” were excluded.

Articles were chosen for revision if published in English and Spanish (languages spoken by the authors) and contained the mentioned keywords in the title. After carrying out an initial filtering process by reading the abstracts, 20 articles were selected for research contribution (Table 1). Each of the papers was then completely read to ensure that they were relevant to the aims of the current research.

In the majority of the articles, the content was concerned with LT, PM, and sustainability in isolation, whilst only a few explicitly combined two of the concepts. The only document found that alluded to the relationship between the three topics is the paper by Galeazzo et al. (2014) (Fig. 1).

The systematic literature review (SLR) for this paper was based on the model developed by Garza-Reyes (2005). It consists of the following five consecutive phases: (1) question formulation, (2) locating studies, (3) study selection and evaluations, (4) analysis and synthesis, and (5) reporting and using the results. Each of these phases explains its objective, method, and tool along with the section of the paper where the information is located (Fig. 2).

**Table 1** Articles selected for research contribution

No.	Authors	Paper name	Year	Journal	Times cited (G. Scholar/ Scopus)
1	Anholon R. Sano A. T.	Analysis of critical processes in the implementation of lean manufacturing projects using project management guidelines	2015	International Journal of Advanced Manufacturing Technology	0/0
2	Aziz, B.	Improving Project Management with Lean Thinking?	2012	Master thesis. Institute of Technology, Linköping University, Sweden	1/No info
3	Ballard, G. Howell, G.	Lean project management	2003	Building Research & Information	159/69
4	Bortolotti, T. Boscari, S. Danese, P.	Successful lean implementation: Organizational culture and soft lean practices	2015	International Journal of Production Economics	18/5
5	Chiarini, A.	Sustainable manufacturing-greening processes using specific Lean Production tools: an empirical observation from European motorcycle component manufacturers	2014	Journal of Cleaner Production	26/13
6	Dhingra, R. Kress, R. Upreti, G.	Does lean mean green?	2014	Journal of Cleaner Production,	14/3
7	Faulkner, W. Badurdeen, F.	Sustainable Value Stream Mapping (Sus-VSM): methodology to visualize and assess manufacturing sustainability performance	2014	Journal of Cleaner Production	29/10
8	Fliedner, G.	Sustainability: a new lean principle	2008	In Proceedings of the 39th annual meeting of the decision sciences institute	16/No info
9	Folinas, D. Aidonis, D. Triantafyllou, D. Malindretos, G.	Exploring the greening of the food supply chain with lean thinking techniques	2013	Procedia Technology	3/0
10	Galeazzo, A. Furlan, A. Vinelli, A.	Lean and green in action: interdependencies and performance of pollution prevention projects	2014	Journal of Cleaner Production	19/11

(continued)

**Table 1** (continued)

No.	Authors	Paper name	Year	Journal	Times cited (G. Scholar/ Scopus)
11	Hines, P. Holweg, M. Rich, N	Learning to evolve: a review of contemporary lean thinking	2004	International Journal of Operations & Production Management	1027/420
12	Höök, M. Stehn, L.	Lean principles in industrialized housing production: the need for a cultural change	2008	Lean Construction Journal	53/No info
13	Longoni, A. Cagliano, R.	Cross-functional executive involvement and worker involvement in lean manufacturing and sustainability alignment	2015	International Journal of Operations & Production Management	0/0
14	Martínez-Jurado, P. J. Moyano-Fuentes, J.	Lean management, supply chain management and sustainability: a literature review	2014	Journal of Cleaner Production	47/15
15	Reusch, P. J. Reusch, P.	How to develop lean project management?	2013	(IDAACS), 2013 IEEE 7th International Conference	3/1
16	Sousa, R. Voss, C. A.	Quality management: universal or context dependent?	2001	Production and Operations Management	179/No info
17	Staats, B. R. Brunner, D. J. Upton, D. M.	Lean principles, learning, and knowledge work: Evidence from a software services provider	2011	Journal of Operations Management	157/63
18	Womack, J. P. Jones, D. T.	Lean thinking	1996	Book	7084/No info
19	Womack, J. P. Jones, D. T. Roos, D.	Machine that changed the world	1990	Book	13575/No info
20	Yusup, M. Z. Mahmood, W. H. W. Salleh, M. R. Yusof, A. S. M.	Review the influence of lean tools and its performance against the index of manufacturing sustainability	2015	International Journal of Agile Systems and Management	1/0

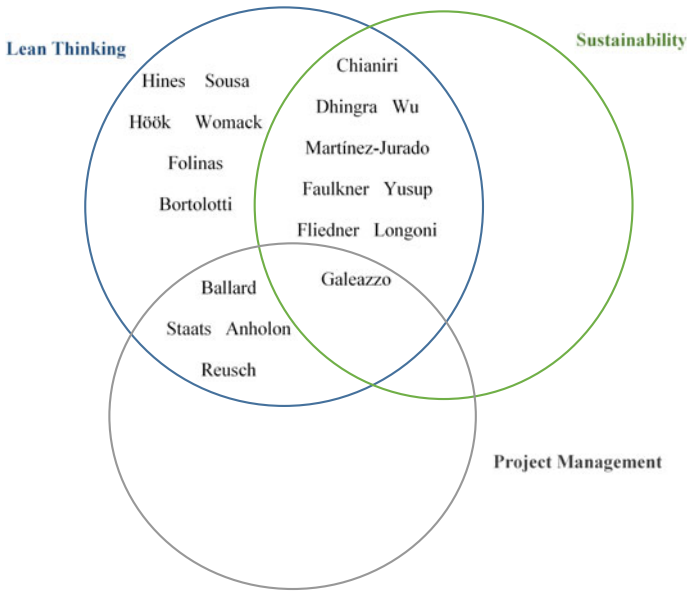


Fig. 1 Authors related by research topic

The following research questions have been addressed based on a SLR of the existing literature on the three topics. The aim of this paper is to answer these using the analysis of the research.

- Question 1: What concepts of LT are relevant for PM and sustainability?
- Question 2: What are the connections between LT and sustainability?
- Question 3: What are the connections between LT and PM?
- Question 4: How can sustainability be integrated in PM practices with LT?

### 3 Results

#### 3.1 *Lean Thinking Principles, Wastes, Tools and Techniques*

##### 3.1.1 Lean Thinking Principles

LT has five principles defined in Womack’s and Jones’ book “Lean Thinking”, which focus on value and elimination of waste. These principles could be applied across a wide range of industrial settings (Sousa and Voss 2001; Hook and Stehn (2008)). The LT principles are:

SRL phases	Objective	Method	Tool	Paper's section
1) Question formulation	Formulating the research questions			2. Methodology
2) Locating studies	Locating, selecting and evaluating relevant literature	Definition and use of electronic database	Emerald, Scencedirect, IEEE, Springer and ProQuest, Scopus, Web of Science and Google Scholar	2. Methodology
3) Study selection and evaluation		Definition of search		
		Definition and use of	"Lean Thinking Project Management", "Lean Project Management", "Lean Sustainability", "Green Lean", "Lean environmental" "Lean Project Management Sustainability" and "Lean Triple Bottom Line".	
4) Analysis and synthesis	Synthesizing and analysing selected articles	Selection of method for synthesis and analysis of qualitative research	Thematic synthesis	2. Methodology
5) Reporting and using the results	Reporting of findings			2. Results and conclusions

Fig. 2 SLR phases, methods, tools and location within the article (Garza-Reyes 2015)

1. Value specification: to define value from the customer’s perspective.
2. Value stream identification: to identify all the steps in the processes that deliver the customer’s values and remove everything that do not add value to the customer.
3. Flow: to take actions that ensure continuous flow in the value stream.
4. Pull: to produce only what the customer wants just in time
5. Perfection: to strive for perfection by delivering what the customer wants and expects through a continuous removal of waste.

**3.1.2 Lean Thinking Wastes**

Every operation involves a mixture of processes that could be regarded as value adding and non-value adding. Non-value adding processes are characterized by wastes of different forms (Folinas et al. 2013). LT classifies these into seven types of waste (Toyota’s seven wastes) in a business process, including the following (Womack and Jones 1996) (Table 2).

**3.1.3 Lean Thinking Tools and Techniques**

The majority of the tools and techniques used in LT aim to bring about changes in a company that enable it to adapt to the needs of the customer (Folinas et al. 2013). The US Environmental Protection Agency (EPA) mentioned eight core methods and tools that organizations use to implement LT systems (EPA 2013). Yusup et al. (2015) investigates how the implementation performance of LT selected tools contributes to establishing sustainable practices (mainly in manufacturing). Table 3 shows the most common tools that are referred to in the reviewed literature.

From the other hand, Hines et al. (2004) go farther and suggest a classification of the LT methods and tools shown in Table 4.

**3.2 Relationship Between Lean Thinking and Project Management**

Currently, PM exists as a universal methodological framework to define the application of knowledge, skills, and tools to manage the projects to meet their requirements. There are several published PM guidelines, and whilst they differ in

**Table 2** Lean thinking types of wastes Womack and Jones (1996)

1. Transport	2. Inventory	3. Motion	4. Waiting
5. Over-processing	6. Overproduction	7. Defects	



**Table 3** LT tools found in the literature reviewed

Authors	LT tool
EPA (2013)	Kaizen, 5S, Total Productive Maintenance (TPM), Cellular Manufacturing/ One-piece Flow Production Systems, Just-in-time (JIT)/Kanban, Six Sigma, Pre-Production Planning (3P) and Lean Enterprise Supplier Networks
Folinas et al. (2013)	Takt Time, Kaizen, Statistical Process Control, Poka-Yoke, 5S, Value Stream Mapping (VSM), Total Quality Management, Kanban, Jidoka
Hines et al. (2004)	TQM, Agile, Drum-buffer-rope, Level scheduling, 6 Sigma, TPM, MRP, TQC, Postponement, TOC, KANBAN, SPC, ERP, Takt Time, APS
PMBok	Cause and effect-diagram, control chart, run charts, scatter diagram and FMEA
Yusup et al. (2015)	5’S, JIT, Root cause analysis, SMED, Takt time, Bottleneck analysis, Standardised work, Jidoka, Poka-yoke, Heijunka, CFA, Kanban and Andon, Visual factory

**Table 4** LT methods and tools classification (Hines et al. 2004)

Quality	Responsiveness	Capacity	Production	Variability	Availability	Control
TQM	Agile	Drum-Buffer-Rope	Level scheduling	6 Sigma	TPM	MRP
TQC	Postponement	TOC	KANBAN	SPC		ERP
			Takt Time			APS

terms of structure, they all cover the same broad principles of PM. Anholon and Sano (2016) mention some relevant publications such as the International Organization for Standardization (ISO), the Project Management Institute (PMI), through the 5th edition of the Project Management Body of Knowledge—PMBok), and the Office of Government Commerce (OGC) in the UK (Prince2 guidelines).

For the aims of the research in this paper, the 5th edition of the PMBok Guide was used. This guideline describes 47 project management processes within five project management process groups, dividing these processes into ten knowledge areas (PMI 2016) (Tables 5 and 6).

**Table 5** PM processes (PMI 2016)

1. Initiating	2. Planning	3. Executing	4. Monitoring & Controlling	5. Closing
---------------	-------------	--------------	-----------------------------	------------

**Table 6** PM areas (PMI 2016)

1. Integration	2. Scope	3. Time	4. Cost	5. Quality
6. Procurement	7. Human Resources	8. Communications	9. Risk Management	10. Stakeholder Management

PMBok refer to the use of several LT tools, including the cause and effect diagram (also known as the fishbone or Ishikawa diagram), control chart, run charts, scatter diagram and FMEA. LT activities are recommended in the Project Quality Management knowledge area. This guide states that “quality improvement initiatives such as Total Quality Management (TQM), Six Sigma, and Lean Six Sigma could improve the quality of the projects” (PMBok 2013).

Reusch and Reusch (2013) stated that “lean management is a management of values” and it can be applied in order to improve project management. In their paper, they cite Stephan Wood, who claims “Quality Management means Lean Management”. Quality Management principles (ISO 9000) such as customer focus, continual improvement, and process approaches, are, among others the bases of lean management (Reusch and Reusch 2013). This is important for linking LT to PM since, as mentioned in the paragraph above, Quality Project Management is one of the ten knowledge areas of PM.

On the other hand, Aziz (2012) relates aspects of LT to PM activities through the following concepts:

- LT is to specify the value of project activities.
- Value is defined by the customer and focuses on long-term strategy benefits.
- Project scope consists of value adding (activities essential for the customer) or non-value adding (waste) activities.
- The elimination of non-value adding activities reduces the project scope.
- Value-adding activities save resources whilst improving the efficiency and effectiveness of projects.

According to this author, “each concept is applicable to all project’s activities including product related activities and administrative activities (project office)”.

### ***3.3 Lean Project Management***

Lean Project Management (LPM), as a concept, was found in some of the documents analysed for this paper. Aziz (2012) proposes the following definition: “LPM is the application of LT in PM, it tends to focus PM toward creating value and preventing waste, LPM improves project productivity”. Reusch and Reusch (2013) based on the definitions of LPM from Leach (2005). Karim and Nekoufar (2011), establish the following LPM principles:

- Specify what creates value from the customer’s perspective.
- Identify all the steps along the process chain.
- Make those processes flow.
- Identify waste—based upon needs and expectations of customers.
- Eliminate waste—based upon needs and expectations of customers.
- Make only what is pulled by the customer.
- Strive for perfection by continually removing wastes.

- Amplify learning.
- Make decisions at the right time.
- Empower the team, build integrity.
- See the whole.

On the other hand, Aziz (2012) analysed the work of Ballard and Howell (2003) who developed a model called the Lean Project Delivery System (LPDS) for construction projects. They state that this model “has emerged from theoretical insights from other industries (lean production). The LPDS focuses on several aspects of project delivery, such as improving dialogue among stakeholders, deferring decisions, process design, eliminating waste, flow and pull” (as cited in Aziz 2012).

Some studies have explored the link between LT and PM in various types of projects. When LT is connected to PM, the construction industry is primarily used as an example (Ballard and Howell 2003). According to Aziz (2012), Staats et al. (2011) explore the possibility to implement LT in software projects, and in doing so, they affirm that organizations learn “through hypothesis-driven problem solving, streamlined communications, simplified processes, and to a lesser degree, specified tasks”.

### ***3.4 Relationship Between Lean Thinking and the Three Sustainability Aspects***

Yusup et al. (2015) links the performance of LT practices with increased levels of sustainability in manufacturing. The author groups them into three aspects of sustainability performance: the competency accomplishment performance (CAP) (related to the social aspect), economic achievement performance (EAP) and environmental responsiveness performance (related to the social aspect) (ERP).

The only document found that mentions the three topics of this research was the paper from Galeazzo et al. (2014). However, the study just focuses on the relation with LT and the environmental aspect of sustainability. Additionally, it uses projects as case studies and not really a relationship with PM practices.

According to Wu et al. (2015), LT is “directly related to a firm’s profitability and indirectly addresses concerns related to environmental and social dimensions”. Fliedner (2008) highlights that “many organizations have found that a by-product of the LT principles is related to environmental performance, even when lean activities were not initiated for environmental reasons”.

Fliender (2008) identifies eight methods and tools that are associated with the environmental benefits (Table 7). The author states that while LT improves processes and saves money through waste reduction and elimination, these methods and tools have also been demonstrated to produce environmental benefits.

Faulkner and Badurdeen (2014) suggest the use of LT tool Value Stream Map (VSM) to identify value added activities or wastes. According to the authors, this

**Table 7** Lean methods and tools associated with environmental benefits (Fliender 2008)

Lean method/Tool	Environmental benefits
Kaizen Events	<ul style="list-style-type: none"> <li>• Uncovering and eliminating hidden wastes and waste generating activities.</li> </ul>
Value Stream Mapping	<ul style="list-style-type: none"> <li>• Magnification of environmental benefits of lean production (e.g., reduced waste through fewer defects, less scrap, less energy usage, etc.) across the network.</li> </ul>
5S	<ul style="list-style-type: none"> <li>• Clean windows reduce lighting requirements.</li> <li>• Spills and leaks noticed more quickly.</li> </ul>
Cellular Manufacturing	<ul style="list-style-type: none"> <li>• Smaller set-up times reduce energy and resource needs.</li> <li>• Fewer product changeovers reduce energy and resource needs.</li> </ul>
Pull Approach	<ul style="list-style-type: none"> <li>• Lower in-process and post-process inventory avoids potential waste from damaged, spoiled, or deteriorated products.</li> </ul>
Total Preventive Maintenance	<ul style="list-style-type: none"> <li>• Increased longevity of equipment decreases need for replacement equipment and associated environmental impacts.</li> </ul>
Six Sigma	<ul style="list-style-type: none"> <li>• Fewer defects which reduce energy and resource needs avoid waste.</li> <li>• Focuses attention on reducing the conditions that result in accidents, spills, and malfunctions, thereby reducing solid and hazardous wastes.</li> </ul>
Pre-production Planning	<ul style="list-style-type: none"> <li>• Reduces waste at the product and process design stage, similar to “Design for Environment” methods</li> <li>• Use of right-sized equipment lowers material and energy requirements.</li> <li>• Reducing the complexity of the production process (“design for manufacturability”) can eliminate or streamline process steps; environmentally sensitive processes can be targeted for elimination, since they are often time-, resource-, and capital-intensive.</li> </ul>
Lean Supplier Networks	<ul style="list-style-type: none"> <li>• Magnification of environmental benefits of lean production (e.g., reduced waste through fewer defects, less scrap, less energy usage, etc.) across the network.</li> </ul>

practice can include metrics for evaluating environmental and societal sustainability performance. A new methodology known as ‘sustainable’ Value Stream Mapping or Sus-VSM was developed and was tested in three case studies (Dhingra et al. 2014).

In a document published online, titled “*Lean Manufacturing and Environment*”, the EPA presented findings from a research study conducted in four American companies by means of observations (EPA 2013). The research underlined how Lean Thinking can be taken into account to improve environmental performance (Chiarini 2014). According to Chiarini (2014) the most relevant outcomes are:

- LT produces an operational and cultural environment that is highly conducive to the minimization of waste and the prevention of pollution.
- LT can be leveraged to produce more environmental improvement, filling key ‘blind spots’ that can arise during Lean implementation.
- LT experiences regulatory ‘friction’ around environmentally sensitive processes.

The US Environmental Protection Agency (EPA) suggests a table of correlation between the LT wastes and their associated environmental effects (EPA 2013). An extract from this table is shown in Table 8.

The relationship between LT implementation and social practices has also emerged in academic research in recent years (Wu et al. 2015). According to Wu et al. (2015), De Treville and Antonakis (2006) establish that LT practices have an impact on social performance, the most important of which is on the internal human resources of the firms. This can be achieved by empowering, educating, motivating, and designing jobs for employees, (Wu et al. 2015).

Wu et al. (2015) make two interesting statements. First, they affirm that “Total Production Maintenance (TPM) activities largely prevent workplace injuries and deaths, contributing to better employee health and safety”. Second, they state that LT practices impact customers primarily through Total Quality Management (TQM) programs. In addition, Wu et al. (2015) remark that researchers such as Jasti and Kodali (2015) recommend covering “a wide range of stakeholders along the supply chain such as suppliers, shareholders, employees, customers, as well as the society as a whole”.

**Table 8** Environmental impacts linked with manufacturing waste taken from EPA (2013) (cited in Chiarini 2014)

Waste type	Environmental impact
Defects	Raw materials consumed in making defective products. Defective components require recycling or disposal. More space required for rework and repair, increasing energy use for heating, cooling, and lighting.
Waiting	Potential material spoilage or component damage causing waste. Wasted energy from heating, cooling, and lighting during production downtime.
Overproduction	More raw materials consumed in making the unneeded products. Extra products may spoil or become obsolete requiring disposal.
Movement and transportation	More energy use for transport. Emissions from transport. More space required for work-in-process (WIP) movement, increasing lighting, heating, and cooling demand and energy consumption. More packaging required to protect components during movement.
Inventory	More packaging to store WIP. Waste from deterioration or damage to stored WIP. More materials needed to replace damaged WIP. More energy used to heat, cool, and light inventory space.
Complexity and Over processing	More parts and raw materials consumed per unit of production. Unnecessary processing increases wastes, energy use, and emissions.
Unused creativity	Fewer suggestions of pollution and waste minimization opportunities.

## 4 Conclusions

In the Results section of this study, the main concepts of the three topics of the literature review were described. It was possible to find theoretical information regarding some links between LT and PM as well as LT and the three concepts of sustainability.

- PMBok guide include the use of LT tools for PM practices.
- This guide states improvement of the project's quality by using LT methodology.
- The LT core elements such as customer focus, continual improvement, process approaches affect positively the PM practices.
- Detection of LT tools and methods associated with environment benefits.
- Relation with firm's profit and LT through waste elimination and costs reduction.
- Impact on social aspect mostly at internal human resources of the organizations and customer.

### *Gaps found in the research which should lead to future research*

The social aspect was not widely developed in the researched articles, just in some cases considered the employee and customer integration but not all the project's stakeholders.

Likewise, there is a lack of information on how LT concepts can contribute to PM to integrate sustainability. A solution could be developed based on a specific model or framework.

## References

- Aziz B (2012) Improving project management with lean thinking? Master thesis. Master of management of innovation and product development. Institute of Technology, Linköping University, Sweden <http://www.diva-portal.org/smash/get/diva2:504715/FULLTEXT01.pdf>. Accessed 10 April 2016
- Anholon R, Sano A (2016) Analysis of critical processes in the implementation of lean manufacturing projects using project management guidelines. *Int J Adv Manuf Technol* 84:2247–2256
- Ballard G, Howell G (2003) Lean project management. *Build Res Inf: Int J Res, Dev Demonstration* 31(2):119–133
- Berggren C, Järkvik J, Söderlund J (2008) 'Agomizing, organic integration, and systems emergency wards: innovative practices in managing complex systems development projects. *Proj Manag J* 39(Supplement 1):S111–S122
- Bortolotti T, Boscari S, Danese P (2015) Successful lean implementation: Organizational culture and soft lean practices. *Int J Prod Econ* 160(1):182–201
- Carvalho H, Duarte S, Cruz Machado V (2011) Lean, agile, resilient and green divergencies and synergies. *Int J Lean Six Sigma* 2(2):151–179
- Chiarini A (2014) Sustainable manufacturing-greening processes using specific Lean Production tools: an empirical observation from European motorcycle component manufacturers. *J Clean Prod* 85(1):226–233

- Chen L, Feldmann A, Tang O (2015) The relationship between disclosures of corporate social performance and financial performance: evidences from GRI reports in manufacturing industry. *Int J Prod Econ* 170(1):445–456
- Dhingra R, Kress R, Upreti G (2014) Does lean mean green? *J Clean Prod* 85(1):1–7
- EPA (2013) Lean manufacturing and environment. US Environmental Protection Agency (EPA)
- Faulkner W, Badurdeen F (2014) Sustainable value stream mapping (Sus-VSM): methodology to visualize and assess manufacturing sustainability performance. *J Clean Prod* 85(1):8–18
- Fliedner G (2008) Sustainability: a new lean principle. In: Proceedings of the 39th annual meeting of the decision sciences institute, Baltimore, Maryland, pp 3321–3326
- Folinas D, Aidonis D, Triantafyllou D, Malindretos G (2013) Exploring the greening of the food supply chain with lean thinking techniques. *Procedia Technol* 8(1):416–424
- Galeazzo A, Furlan A, Vinelli A (2014) Lean and green in action: interdependencies and performance of pollution prevention projects. *J Clean Prod* 85(1):191–200
- Garza-Reyes JA (2015) Lean and green – a systematic review of the state of the art literature. *J Clean Prod* 102(1):18–29
- Goerke M, Schmidt M, Busch J, Nyhuis P (2015) Holistic approach of lean thinking in learning factories. *Procedia CIRP* 32(1):138–143
- Hines P, Holweg M, Rich N (2004) Learning to evolve: a review of contemporary lean thinking. *Int J Oper Prod Manag* 24(10):994–1011
- Hook M, Stehn L (2008) Applicability of lean principles and practices in industrialized housing production. *Constr Manag Econ* 26(10):1091–1100
- Hozak K, Olsen E (2015) Lean psychology and the theories of “Thinking, Fast and Slow”. *Int J Lean Six Sigma* 6(3):206–225
- Khanzode A, Fischer M, Reed D (2005) Case study of the implementation of the lean project delivery system (LPDS) using virtual building technologies on a large healthcare project. In: 13th international group for lean construction conference: proceedings, p. 153, International Group on Lean Construction
- Levy Y, Ellis TJ (2006) A systems approach to conduct an effective literature review in support of information systems research. *Informing Sci: Int J Emerg Transdiscipline* 9(1):181–212
- Longoni A, Cagliano R (2015) Cross-functional executive involvement and worker involvement in lean manufacturing and sustainability alignment. *Int J Oper Prod Manag* 35(9):1332–1358
- Pons D (2008) Project management for new product development. *Project Manag J* 39(2):82–97
- Project Management Institute (PMI) <http://www.pmi.org/en.aspx>. Accessed 15 May 2016
- Reusch PJ, Reusch P (2013) How to develop lean project management? In: 2013 IEEE 7th international conference on intelligent data acquisition and advanced computing systems (IDAACS), vol 2, pp 547–550. IEEE
- Shah R (2003) Lean manufacturing: context, practice bundles, and performance. *J Oper Manage* 21(2):129–149
- Shah R, Ward PT (2007) Defining and developing measures of lean production. *J Oper Manage* 25(4):785–805
- Sousa R, Voss C (2001) Quality management: universal or context dependent? *Prod Oper Manag* 10(4):383–404
- Staats B, Brunner D, Upton D (2011) Lean principles, learning, and knowledge work: evidence from a software services provider. *J Oper Manag* 29(5):376–390
- Womack, J P, Jones, D T, & Roos, D 1990, ‘Machine that changed the world’, Simon and Schuster
- Womack JP, Jones DT (1996) Lean thinking. Simon and Shuster, New York
- Wu L, Subramanian N, Abdulrahman MD, Liu C, Lai KH, Pawar KS (2015) The impact of integrated practices of lean, green, and social management systems on firm sustainability performance—evidence from Chinese fashion auto-parts suppliers. *Sustainability* 7(4):3838–3858
- Yusup M, Mahmood W, Salleh M, Yusof A (2015) Review the influence of lean tools and its performance against the index of manufacturing sustainability. *Int J Agile Syst Manag* 8:2

**Part II**  
**Civil Engineering and Urban Planning:**  
**Construction and Architecture**



# Planning and Control of Civil Engineering Works in Peru: Current State and Improvement Proposal



P. M. Carbajal, E. Pellicer, S. Santos-Fonseca, C. Torres-Machi and P. Ballesteros-Pérez

**Abstract** Planning and control are the basic functions of project management, and this is also true in the construction sector. Peru is growing in the last decade at a very high pace and projected and constructed infrastructure reflects this growing rate. This communication analyzes the use and implementation in that country of different planning and control techniques and methods, as well as the difficulties that arise for a proper implementation of these functions in civil engineering works. It also explores the use of alternative techniques and methods based on Lean Construction. All this will be implemented through a state of the art in-depth review. From this analysis, variables will be extracted that are useful to formulate the questions of the survey. The field research consists in obtaining answers from the professionals involved in infrastructure design, construction and management. Data analysis and results discussion allow to elaborate a proposal to improve construction management in the Peruvian context.

**Keywords** Control · Construction · Planning · Peru · Techniques

---

P. M. Carbajal · E. Pellicer (✉) · S. Santos-Fonseca · C. Torres-Machi  
Universitat Politècnica de València, Camino de Vera S/N, 46022 Valencia, Spain  
e-mail: pellicer@upv.es

P. M. Carbajal  
e-mail: paocar6@cam.upv.es

S. Santos-Fonseca  
e-mail: salazar.santos@grupolobe.com

C. Torres-Machi  
e-mail: critorma@upv.es

P. Ballesteros-Pérez  
University of Reading, Whiteknights, Reading RG6 6AW, UK  
e-mail: p.ballesteros@reading.ac.uk

# 1 Introduction

Project management is the application of knowledge, skills, tools and techniques to project activities, in order to comply with project requirements (PMI 2013). Using a more adapted definition for the construction sector, it can be said that management is the coordination and integration process of project activities to ensure that they are developed in an efficient and effective way using scarce resources. According to the *Project Management Institute* (PMI 2013), project management processes can be grouped in five categories: initiation, planning, execution, control and closure. Planning and control are intrinsically related, because it makes no sense to control if a previous plan does not exist and vice versa (Pellicer et al. 2014); for instance: planning and control processes are necessary in all the knowledge areas defined in the *Project Management Body of Knowledge* (PMBok) (PMI 2013).

Construction sector companies manage and produce through projects (Pellicer et al. 2014); in this case “project” is used as a general term, that can be particularized as “work” when executing the project (infrastructure construction phase (Pellicer et al. 2012). An adequate project and works management in the construction sector is essential to comply with costs, deadlines and quality restrictions; planning and control are the basic processes that lead to success (Pellicer et al. 2014). They can be approached from different points of view, as stated by PMI (2013) by focusing in their ten knowledge areas; nonetheless, aspects related with time and costs are often specially critical in construction (Pellicer et al. 2014).

In the specific case of the Peruvian construction sector, contrary to what is happening in Spain, this sector has grown continually in the last ten years. This is essentially happening due to growing family income, higher public and private investments, and the improvement of house purchase financing conditions. The growth rate in 2015 is about 6% (MRE 2015). This is essentially centered in road infrastructure and residential building (ProInversión 2015).

Considering the described context, the aim of this study is to identify existent problems in temporary planning and control processes in the Peruvian construction sector. The decision to center this study only in the temporary planning and control processes is due to the breadth of the subject. For practical effects, the terms “temporary planning” and “programming” will be used indistinctively. This research has been developed in two phases. In the first, the theoretical and methodological phase, the most significant contributions in the field of works temporary planning and control have been analyzed, with the purpose of identifying the critical variables. The second phase is devoted to empirical and analytic validation, and it is achieved through a survey conducted amongst professionals of the Peruvian construction sector that have participated in temporary planning and control processes. Data analysis is based on statistical sample characterization, descriptive statistics and exploratory factorial analysis. For this purpose, this communication is organized as follows: in the first place, the survey design is explained, justifying the variables used, based on the existing literature. In the next step, the statistical analysis made and the results obtained are reported. Finally,

these results are discussed, providing the most significant contributions of this research.

## 2 Research Design

As it was mentioned above, the survey intends to identify problems present in the temporary planning and control processes in the Peruvian construction sector. The first step is the identification and definition of the variables to be taken into account in the survey. A bibliographic search allowed to identify articles and researches in which subjects related to works temporary planning and control were developed. In these documents variables were identified that allowed to structure and develop the survey; this way, the survey questions are duly referenced and related to the existing literature.

21 questions were formulated, grouped in four initial constructs: (1) management; (2) temporary planning; (3) temporary control; and (4) new philosophies and techniques. The questions, grouped by constructs, are shown in Table 1.

The survey questionnaire is divided in four parts:

1. Brief explanation about the research.
2. Survey respondents' characterization: studies, professional experience, position and sub-sector.
3. Research questions: 21 questions, described in Table 1. Taking into account their measurement scale, there are two types of variables: nominals (N) and interval (I) variables. Nominal variables are used to verify realities and actions happening in the environment (nine questions of this type were considered). For interval variables, the measurement scale used is a five points Likert, where the five answer alternatives are linked to the corresponding numerical values.
4. Comments made by respondents regarding the survey.

The survey is elaborated in an "online" format using the application Google Forms. A link is generated for its subsequent delivery by electronic mail or for publication in social media or different computer support. The survey can be answered easily in less than fifteen minutes.

A pilot test was applied to 18 professionals with experience in planning and control processes. This test allowed clarifying some wording and overcoming deficiencies which are common in this type of research. Subsequently, the survey was disseminated.

Regarding the sampling type, in a first phase it is random or probabilistic: Peruvian professional groups reached through social media Facebook and LinkedIn, as well as professionals from the Association of Engineers of Peru. The second phase is a non-probabilistic sample, of convenience or "snowball". It is not random because the survey is sent to other professionals previously known, and they, at the same time, send the survey to other acquaintances in the same sector.

**Table 1** Survey variables and questions and key references, grouped by constructs

Variable	Type	Question	References
<i>Construct 1: management</i>			
Project objectives	I	Are work objectives and goals expressed a priori in a clear and accurate manner? (P_5)	(Laufer and Tucker 1987; Howell et al. 1993; PMI 2013)
Client requirements	I	Is an activity program prepared and presented to the client to be verified and accepted? (P_6)	(Laufer and Tucker 1987; PMI 2013; Braimah 2014)
Work suitable contract planning	I	Is the chronogram included in the contract the one really used for planning and monitoring the work? (P_7)	(Olawale and Sun 2015)
Motivation	N	What are the reasons for the preparation of a work programming and control? (P_9)	(González et al. 2010; Olawale and Sun 2015)
Identified problems	N	What are the main problems arising during the work execution? (P_21)	(Laufer et al. 1994; Li et al. 2006)
<i>Construct 2: temporary planning</i>			
Appropriate programming for construction	I	Is the planning included in the contract enough for work execution? (P_8)	(Laufer et al. 1994; Li et al. 2006; Olawale and Sun 2015)
Duration estimation	N	How is the activities duration estimation made? (P_10)	(Laufer et al. 1994; Li et al. 2006; Olawale and Sun 2015)
Temporary planning techniques	N	Which technique, method or tool is the most used to elaborate a work programming? (P_11)	(González et al. 2010; Zanen and Hartmann 2010)
Tool justification	N	For what reason is this tool, method or technique used to elaborate a program? (P_12)	(González et al. 2010; Zanen and Hartmann 2010)
Software use	N	Which software is normally used for work program elaboration? (P_13)	(Laufer et al. 1994; Winch and Kelsey 2005; Li et al. 2006)
Utilization frequency	N	How often is the work program updated? (P_14)	(Olawale and Sun 2015)
<i>Construct 3: temporary control</i>			
Greater importance of cost control	I	During work execution, is cost control performed rather than deadline control? (P_15)	(Olawale and Sun 2015)
Planning verification	I	Is any process performed which allows verifying that the work execution is undertaken according to plan? (P_16.1)	(Olawale and Sun 2015)
Reports	I	Is a specific format used to group all the information obtained during the control process? (P_16.2)	(Olawale and Sun 2015)

(continued)

**Table 1** (continued)

Variable	Type	Question	References
Information analysis	I	Is any type of analysis of the information available made that allows to take corrective measures in a timely manner? (P_16.3)	(Olawale and Sun 2015)
Control technique	N	Which technique is used to control work progress? (P_17)	(González et al. 2010; Olawale and Sun 2015)
Control frequency	N	How frequently is work progress control performed? (P_18)	(González et al. 2010; Olawale and Sun 2015)
Feedback	I	Is timetable feedback performed considering changes emerged during execution? (P_19)	(Rodriguez et al. 2011; Pellicer et al. 2014)
<i>Construct 4: new philosophies and technologies</i>			
Final executor participation	I	When programming is made, is the final executor's (subcontractor, supplier, person in charge, foreman, etc.) opinion considered? (P_22)	(Koskela 1992; Botero and Alvarez 2005; Rodriguez et al. 2011)
Final executor feedback	I	Do you consider that there is feedback of the periodic control results for these final executors? P_23)	(Koskela 1992; Botero and Alvarez 2005; Rodriguez et al. 2011)
BIM/4D use	I	Is some type of program elaborated which integrates virtual geometric construction (3D) with another type of information (materials, processes, deadlines or costs)? (P_24)	(Azhar 2011; Sacks et al. 2010; Sacks and Pikas 2013)

Note N, Nominal variable; I, Interval variable

The survey population is integrated by Peruvian professionals from the construction sector, who at some moment in time have performed work planning and control. Due to the existence of professionals belonging to a professional association and others who are not associated, the population is considered infinite regarding statistical representativeness. Thus, the expression that relates the sample size to the statistical error is (Field 2009):

$$n = z^2 pq / e^2 \tag{1}$$

The number of answers (sample size, n) obtained in this research has been 158. This sample is statistically representative for a confidence level of 95% (p = q=0.5; z = 1.96) and an error margin (e) of 7.80%. The reliability of the survey is calculated using the Cronbach Alfa, which allows to determine its internal consistency, obtaining a value of 0.802. This value can be considered good (Field 2009). For the calculation of the Cronbach Alfa only the interval variables were used. All statistical calculations have been performed using the application SPSS version 23.

### 3 Results Analysis

#### 3.1 Sample Characterization

Once the data were obtained, they were purged and subsequently analyzed. The survey respondents can be characterized through four basic variables: studies, professional experience, position and sub-sector. The majority of the respondents are civil engineers (85%) and architects (8%); the remaining respondents are industrial engineers or engineers with another specialization. Table 2 shows the professional experience of the survey respondents indicated in years.

Regarding the sub-sector, 58% is the highest percentage corresponding to professionals working in the building sub-sector, followed by road works (18%). Regarding the work that they perform in the construction field, the most representative percentage corresponds to production manager, with 35%, followed by 21% and 20% for chief of the work control office and control assistance engineer respectively.

#### 3.2 Descriptive Statistical Analysis

The mean and standard deviation values of each of the interval variables are represented in Table 3. The variables with which the respondents are most in agreement are: client requirements (P\_6); information analysis (P\_16.3); planning verification (P\_16.1); and reports (P\_16.2). The variables with which the respondents are most in disagreement are: use of BIM/4D (P\_24); adequate programming for construction (P\_8); contract planning adequate for the work (P\_7); and more importance of cost control (P\_15).

Regarding nominal variables, the results obtained are shown below for the more representative of them, stating their relative frequency:

- Reasons for the elaboration of a work program and control (P\_9):
  - Comply with the work execution in the contractual date: 22.7%
  - Complete the work execution within the contractual budget: 16.7%
  - Execute the work so that all resources are organized and on schedule: 23.5%
  - Elaborate a contingency plan to address unidentified problems: 10.3%

**Table 2** Professional experience of respondents

Professional experience	Percentage (%)
Less than 5 years	41.8
Between 6 and 10 years	44.9
Between 11 and 15 years	7.6
Between 16 and 20 years	3.8
More than 21 years	1.9

**Table 3** Statistical descriptions of interval variables

Variable	Mean	Standard deviation
P_5	3.77	1.199
P_6	4.25	0.886
P_7	2.91	1.191
P_8	2.22	1.013
P_15	3.41	1.017
P_16.1	3.81	1.029
P_16.2	3.82	0.974
P_16.3	3.86	0.967
P_19	3.69	1.021
P_22	3.76	0.718
P_23	3.76	0.980
P_24	3.51	0.969

- Avoid execution of nonproductive works and improve productivity: 14.6%
- Comply with other contractual conditions required by the client: 11.5%
- Other: 0.6%
- Activities duration estimation (P\_10):
  - Experience: 33.0%
  - Historic data base: 18.8%
  - Yield calculation: 41.3%
  - Three values estimation (optimal, appalling and medium): 6.6%
  - Other: 0.3%
- Techniques, tools or methods used to elaborate the activities program (P\_11):
  - Bar or Gantt diagram: 75.9%
  - Network Diagram: 7.0%
  - Technique for programming by milestones: 4.4%
  - Space-time diagram (balance line): 5.1%
  - Earned value method (EVM): 5.1%
  - Other 2.5%
- Software for programming (P\_13):
  - Microsoft Project: 64.6%
  - Primavera: 10.1%
  - Excel: 22.2%
  - Planner Project: 0.6%
  - Power Project: 1.9%
  - Other: 0.6%

- Temporary work control frequency (P\_18):
  - Daily: 20.3%
  - Weekly: 48.1%
  - Bimonthly: 18.4%
  - Monthly: 12.0%
  - Never: 1.3%
  - Other: 10.1%
- Main problems identified during work execution (P\_21):
  - Incomplete blueprints/specifications, techniques/documents: 12.00%
  - Inadequate initial project planning: 10.00%
  - Lack of communication and coordination between the parties: 7.30%
  - Bad work resources management: 6.80%
  - Permissions obtainment/authorization: 6.50%
  - Waiting time for materials approval: 5.40%
  - Productivity overestimation: 5.40%
  - Blueprints preparation and approval: 5.00%
  - Excessive bureaucracy and lack of cooperation on the part of the sponsor: 60%
  - Sponsor's decision making delay: 4.35%

### 3.3 *Exploratory Factorial Analysis*

An exploratory factorial analysis is performed, using the main components method, with the aim of finding which the real constructors are and comparing them with the previously formulated. The exploratory factorial analysis is performed in the first instance, with the 12 interval variables considered in Table 1. As an initial step, it is necessary to verify the commonality of each of these variables. Commonality is the part of the variability of every original variable explained by common factors (Field 2009). It must be taken into account that, the extraction values near to one will adequately explain the variables; on the contrary, values lower than 0.500, do not allow for an adequate explanation of the final solution. Variables P\_16.2, P\_16.3 and P\_16.1, with values 0.848, 0.846 and 0.809, are the ones which better explain the model. However, variables P\_6, P\_15 and P\_22, with values lower than 0.500, do not adequately explain the model. Thus, it was decided not to take them into account in the subsequent factorial analysis.

Next, evaluation tests are carried out, which will indicate if it is possible to perform the factorial analysis for the group of these nine interval variables. These tests are the Kaiser, Meyer and Olkin (KMO) test and the Bartlett sphericity test. The KMO test relates the correlation coefficients observed between variables. As the result of this test approaches one, a higher correlation exists between variables.



**Table 4** KMO and Barlett tests

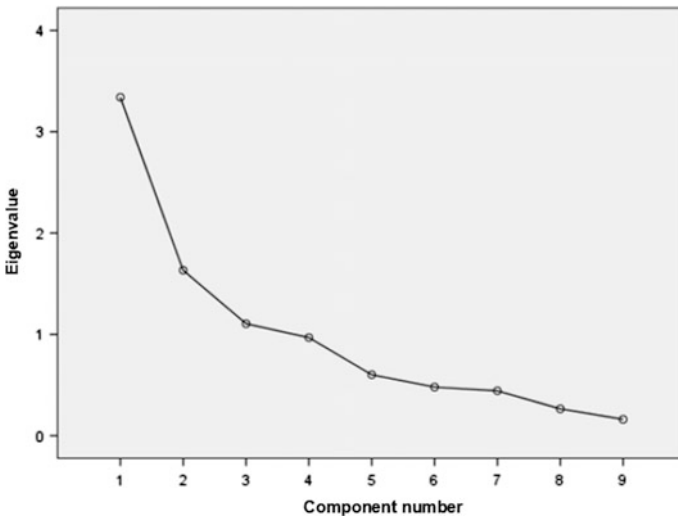
Kaiser-Meyer-Olkin measure of simple adequacy		0.740
Bartlett sphericity test	Approx. Chi-square	526,922
	Gf	36
	Sig.	0.000

In the case study, the obtained value is 0.740, which is considered a good value (Field 2009). Table 4 shows the results.

On the other hand, the sphericity test is used to prove the null hypothesis that the variables are not correlated between them, that is, the correlations matrix is the identity. When this hypothesis is rejected, it is proven that some correlation exists between variables and the analysis can continue. In this test, if Sig. (p-value) < 0.05 the factorial analysis can be applied and if Sig. (p-value) > 0.05 the factorial analysis cannot be applied (Field 2009). In this case, the p-value is 0.00, and thus it is demonstrated that there is no correlation between variables and one can proceed with the principal components analysis. Table 4 shows the results.

Regarding the number of components to be obtained, the sedimentation graph included as Fig. 1, marks the main inflection point in the third component (Field 2009). For this reason, only the first three principal components are considered (or research final constructs).

Table 5 shows the explained percentage of variance each one of the three extracted principal components. Their addition includes the 67.55% of the variability of the nine variables considered. From the total, the first component explains 37.12%, the second one explains 55.26%, and the third one explains 67.55%.



**Fig. 1** Sedimentation graph

**Table 5** Total variance explained

Nº	Initial eigenvalues			Sum of charges removal squared			Sum of charges rotation squared		
	Total	% Variance	% Accumulated	Total	% Variance	% Accumulated	Total	% Variance	% Accumulated
1	3.341	37.117	37.117	3.341	37.117	37.117	2.994	33.272	33.272
2	1.633	18.147	55.264	1.633	18.147	55.264	1.699	18.876	52.148
3	1.106	12.286	67.550	1.106	12.286	67.550	1.386	15.402	67.550
4	0.969	10.764	78.314						
5	0.602	6.687	85.001						
6	0.480	5.330	90.332						
7	0.443	4.926	95.257						
8	0.265	2.948	98.205						
9	0.162	1.795	100.000						

To obtain these results, the Varimax rotation method has been used, with Kaiser normalization; rotation converges in five iterations. As part of the procedure, absolute values lower than 0.400 are removed, in order to discard variables which have no significance (Field 2009). In Table 6, the values of the variables are shown as well as their grouping in the three principal components. After Table 6, a more detailed explanation of these components is offered.

Initially, four components or constructs were devised, which were finally reduced to three principal components. In these three principal components, the form variables are grouped in so that the model can adequately be explained. Consequently, the initial constructs are redefined according to the principal components drawn. Their composition is as follows. In the first construct, P\_16.2, P\_16.3 and P\_16.1 the variables are grouped because they are the most related with this first component. Initially, these variables belonged to the third component called control: therefore, the initial denomination will be still used. In the second construct, variables P\_8, P\_7 and P\_24 are grouped. Initially, variable P\_8 belonged to a component called planning, so this same name will be used. Similarly, variables P\_7 and P\_24 are related to this category. The third construct concentrates variables P\_5 (Project Objectives) and P\_23 (Feedback to Final Executors), and they seek for a relationship between the objectives and the project result, so this name will be assigned to this construct.

**Table 6** Rotated principal components matrix

Variable	C1	C2	C3
Do you perform any type of analysis of the information obtained, which allows to take corrective measures in time? (P_16.3)	0.904		
Do you use any type of format in which the information obtained during the control process is grouped? (P_16.2)	0.886		
Do you perform any process which allows to verify that the work execution is proceeding according to plan? (P_16.1)	0.866		
Do you perform a feedback of the timetable including changes made during execution? (P_19)	0.614		
Is the planning included in the contract enough for work execution? (P_8)		0.827	
Is the timetable included in the contract the one really used for planning and work monitoring? (P_7)		0.816	
Do you prepare any type of program which integrates virtual geometric construction (3D) with other type of information (materials, processes, delivery times or costs)? (P_24)		0.550	
Are work objectives and goals stated a priori in a clear and precise manner? (P_5)			0.847
Do you consider that there is a feedback of the periodic control toward these final executors? (P_23)			0.608

## 4 Discussion

One of the critical success factors in a work is to have clear and accurate goals and objectives. In practice, during the planning stage, the general tendency is to have several and inconsistent objectives. From the survey results obtained, it can be said that, in the context of Peruvian construction, there are differences of opinion regarding the precision and clarity with which projects' goals and objectives are presented to the construction teams (either planning or execution) before the beginning of the construction works. This can be interpreted as one of the problems of construction in Peru and can be considered as part of the factors that inhibit the success of many works.

In the context of the Peruvian construction sector, professionals often prepare a work program (master program) for client approval. This shows that, from the initial stage, the client is usually involved in the project's execution. This involvement is beneficial for problem solving in a fast and timely manner. According to Olawale and Sun (2015), the construction team (either planning or construction) usually prepares a more ambitious schedule than the one included in the contract. From the survey results obtained, it can be concluded that the Peruvian construction sector is not oblivious to this reality. However, this situation can present either benefits or difficulties; benefits because shorter and less costly construction projects could be executed; difficulties, because the product quality could be compromised because of the desire to achieve more ambitious objectives, which could lead to re-works, costs overruns and longer delivering times.

Among the main reasons why it is considered important to elaborate a work program and control scheme, the respondents indicated that the three principal reasons were: to execute the work in such a way that resources (materials, human resources and machinery) were organized, to comply with work execution within the contractual delivery date and to finish the work execution within the budget. This can be interpreted as complying with the essence of planning: strategies formulation for the execution of a certain amount of work, within a predetermined timeline and cost and under quality standards.

Regarding the way to make an estimate of the duration of project activities, these estimates are often made through calculations (of performance) and the use of experience. The literature shows (Li et al. 2006; Olawale and Sun 2015) that activities duration are often based in suppositions frequently inaccurate and only from time to time they are made under a rigorous analysis of the information. The Peruvian construction environment is not unfamiliar with this fact and these types of estimations are still in use to determine activities duration.

Prior studies (González et al. 2010; Zanen and Hartmann 2010) highlight that the majority of the construction sector's businesses and professionals still prefer the use of the bar or Gantt diagram for work programming elaboration; this is verified by analyzing the reality of Peru's environment which, according to the results obtained by the survey, prefers this tool to elaborate activity programs. Moreover, this fact allows to deduce that innovation in programming procedures does not show an

important progress. In order to deepen the analysis of the prior point, the respondents were asked to justify this preference; the vast majority of the respondents indicated that they used the bar diagram because it is easy to read and allows comparing costs and times. Also because it allows to better visualize the sequence of activities and the critical path. However, the generalized use of this type of procedures in high complexity projects can create visualization problems of the relationship between activities and of the activities themselves. Moreover, in large and complex projects, Gantt representation generates visual fatigue, thus executers tend to reject these types of tools.

Regarding software preference for work programming elaboration, results indicated that the most selected was Microsoft Project. The reason is that Microsoft Project is relatively a less expensive program and easy to use; moreover, its use is more standardized among professionals of the Peruvian construction environment.

Regarding the higher importance of cost control over time control, the literature indicates that the majority of the construction professionals apply project control techniques; however, the tendency is to control costs more rigorously than time (Pellicer et al. 2014). Due to the results obtained, it can be concluded that this fact would not be met in the construction environment in Peru, where time is prioritized, according to the survey results.

Regarding tasks (planning, monitoring, reporting and analysis) included in the control process, it can be concluded that in the construction environment in Peru the control process is performed systematically, going through the different control tasks. The frequency of the application of work progress control is often weekly. The generalized concept is met that control is the main concern, more than the adequate use of planning. This is also reflected in the factorial analysis, where the control related component explains more than the one corresponding to planning.

Regarding technology use, such as BIM, it can be concluded that, in the Peruvian construction environment, it is still not being implemented in the planning and control processes in construction. This can be due, according to the literature, to the fact that BIM still does not have standard instructions that allow a better knowledge of its uses and applications. On the one hand, it does not have a software capable of integrating processes in a standardized manner; and in the other hand, resistance to change traditional procedures in order to use more innovative procedures can be due to the fear on the part of the construction company of losing control during the construction process.

## 5 Conclusions

This study allowed identifying the main problems present in work programming and control in Peru, such as lack of clarity in goals and objectives prior to the beginning of work execution. The estimation of project activities' duration is made based on calculations and personal experience; that is, under often inaccurate suppositions. Work programming elaboration still tends to be made using the bar of

Gantt diagram, which is a tool, although popular, excessively simple for some projects. The implementation and use in planning and control processes, of innovative technologies such as the last planner system or the BIM is not generalized.

As it has been previously mentioned, the concern over control is greater than over planning. It is clearly demonstrated by the factorial analysis, as well as in the answer to some specific questions already analyzed. In the examination performed, three macro-variables have been obtained, which explain better the issue of temporary planning and control of works in Peru. These variables have been classified in three categories: control, planning and relationship between objectives and results. The best interpretation is provided by control (a 37% of 68% of the explained variance). It can be deduced that the monitoring process of the principal objectives of the construction project is more important than the clear and concrete definition of those objectives, which should be previously identified in the planning stage.

## References

- Azhar S (2011) Building information modeling (BIM): Trends, benefits, risks, and challenges for the AEC industry. *Leadersh Manag Eng* 11:241–252. [https://doi.org/10.1061/\(ASCE\)LM.1943-5630.0000127](https://doi.org/10.1061/(ASCE)LM.1943-5630.0000127)
- Botero LF, Alvarez ME (2005) Last planner, un avance en la planificación y control de proyectos de construcción: Estudio del caso de la ciudad de Medellín. *Ingeniería y Desarrollo* 17:148–159
- Braimah N (2014) Understanding construction delay analysis and the role of preconstruction programming. *J Manag Eng* 30:04014023. [https://doi.org/10.1061/\(ASCE\)ME.1943-5479.0000216](https://doi.org/10.1061/(ASCE)ME.1943-5479.0000216)
- Field A (2009) *Discovering statistics using SPSS*, 3rd edn. SAGE, London, UK
- González JA, Solís R, Alcudia C (2010) Diagnóstico sobre la planeación y control de proyectos en las PYMES de construcción. *Revista de la Construcción* 9:17–25. <https://doi.org/10.4067/S0718-915X2010000100003>
- Howell G, Laufer A, Ballard G (1993) Uncertainty and project objectives. *Project Appraisal* 8:37–43. <https://doi.org/10.1080/02688867.1993.9726884>
- Koskela L (1992) *Application of the new production philosophy to construction*. Center for Integrated Facility Engineering, Stanford University
- Laufer A, Tucker RL (1987) Is construction project planning really doing its job? A critical examination of focus, role and process. *Constr Manag Econ* 5:243–266. <https://doi.org/10.1080/01446198700000023>
- Laufer A, Tucker RL, Shapira A, Shenhar AJ (1994) The multiplicity concept in construction project planning. *Constr Manag Econ* 12:53–65. <https://doi.org/10.1080/01446199400000007>
- Li B, Austin SA, Thorpe T (2006) Management and planning of a collaborative construction planning process. In: *Proceedings of International Conference on Asia-European Sustainable Urban Development*. Chongqing, China
- MRE, (Ministerio de Relaciones Exteriores) (2015) *Guía de Negocios e Inversión en el Perú*. Lima, Peru
- Olawale Y, Sun M (2015) Construction project control in the UK: Current practice, existing problems and recommendations for future improvement. *Int J Project Manage* 33:623–637. <https://doi.org/10.1016/j.ijproman.2014.10.003>

- Pellicer E, Al-Shubbak A, Catalá J (2012) Hacia una visión sistémica del ciclo de vida de la infraestructura. *Revista de Obras Públicas* 159:41–48
- Pellicer E, Yepes V, Teixeira JC, Moura H, Catalá J (2014) *Construction management*. Wiley-Blackwell, Oxford, United Kingdom
- PMI (2013) *A guide to the project management body of knowledge – PMBoK, 5th edn*. Project Management Institute, Newton Square, USA
- ProInversión (2015) *El Perú en un Instante: Resultados Macroeconómicos*. Ministerio de Economía y Finanzas - Agencia de Promoción de la Inversión Privada (ProInversión), Lima, Peru
- Rodríguez AD, Alarcón LF, Pellicer E (2011) La gestión de la obra desde la perspectiva del último planificador. *Revista de Obras Públicas* 3518:35–44
- Sacks R, Koskela L, Dave BA, Owen R (2010) Interaction of lean and building information modeling in construction. *J Constr Eng Manag* 136:968–980. [https://doi.org/10.1061/\(ASCE\)CO.1943-7862.0000203](https://doi.org/10.1061/(ASCE)CO.1943-7862.0000203)
- Sacks R, Pikas E (2013) Building information modeling education for construction engineering and management: Industry requirements, state of the art, and gap analysis. *J Constr Eng Manag* 139:04013016. [https://doi.org/10.1061/\(ASCE\)CO.1943-7862.0000759](https://doi.org/10.1061/(ASCE)CO.1943-7862.0000759)
- Winch GM, Kelsey J (2005) What do construction project planners do? *Int J Project Manage* 23:141–149. <https://doi.org/10.1016/j.ijproman.2004.06.002>
- Zanen P, Hartmann T (2010) *The application of construction project management tools*. VISICO Center, University of Twente, Twente, Netherlands

# Experiences on MEF Simulation for Linear Concrete Elements with the ATENA Tool



S. Laserna, E. Alcázar, J. Cervera and J. Montero

**Abstract** The modelling of concrete is a very important advance for optimizing structural elements, since it allows to simulate the expected behavior for elements which will be manufactured and determines the weakest points on the design with no need to perform preliminary tests or small scale models. Due to the complex and heterogeneous characteristics of the concrete behavior, research on the material models adapted to the real response of the concrete is getting more advanced. In this way, the ATENA commercial software has been specially developed to perform nonlinear FEM analysis on concrete elements in an easy way. This communication summarizes experience using ATENA for analyzing different lineal elements of structural concrete on the ETSIAM of Albacete. Thereby, different models of (a) reinforced, (b) pre-stressed, and (c) recycled concrete elements have been performed to compare the behavior on real experimental tests with the modelling results. This comparative work allows contrasting and calibrating ATENA for different concrete structural situations. Results of the models show a very good fit to the experimental results and also determine the most important values to calibrate the material models on each situation.

**Keywords** Modelling · Finite element method · Concrete · ATENA

---

S. Laserna · E. Alcázar · J. Cervera · J. Montero (✉)

Dpto. de Producción Vegetal y Tecnología Agraria, Escuela Técnica Superior de Ingenieros Agrónomos y de Montes, Universidad de Castilla-La Mancha, Campus Universitario S/N, 02071 Albacete, Spain

e-mail: [jesus.montero@uclm.es](mailto:jesus.montero@uclm.es)

S. Laserna

e-mail: [santiago.laserna@uclm.es](mailto:santiago.laserna@uclm.es)

E. Alcázar

e-mail: [elena.alcazar@uclm.es](mailto:elena.alcazar@uclm.es)

J. Cervera

e-mail: [jorge.cervera@uclm.es](mailto:jorge.cervera@uclm.es)



# 1 Introduction

Modelling through the Finite Element Method (FEM) represents a fundamental support for complex element design, because it allows to analyze the different designs for an element before its manufacturing, and the behavior results are very near those obtained when the actual element is built.

With these techniques widely known in many sectors, design, optimization and production processes of any element are streamlined. This allows to obtain a final product in less time, with the corresponding economic savings for the manufacturer.

In the field of structural concrete, classical theories of analysis along with experience have been enough for many years to solve simple constructive elements. However, with technological and social development new constructive problems have arisen for which classical theories do not find a reliable answer. This is the reason why many authors propose the use of FEM to find a practical solution. The application of the finite element method to reinforced concrete behavior modeling has been and still is widely studied by many authors. A very thorough bibliographic review on the FEM application for linear and no linear analysis of reinforced concrete structures was performed by the American Society of Civil Engineers (ASCE) (Nilson 1972; Meyer and Okamura 1985; Isenberg 1991).

Nowadays, many research efforts on concrete nonlinear analysis are still ongoing (Karpenkoa et al. 2015; Mihai et al. 2016). These efforts are centered on finding the answer to cracking in concrete elements such as beams, decks or walls caused by tensile stresses. In this way, many specific models are generated which contribute to improve the understanding of this heterogeneous material behavior to the point of finding accurate answers to these issues.

The integration of all these models represents a challenge for their practical application from an engineering point of view, due to their heterogeneity which makes their complete knowledge intractable. Nowadays, calculation tools are available which integrate the main models and all the efforts are now concentrated on verifying their functionality, when comparing the analyses made by these tools with the actual experiences. A revision of multiple damage models and their implementation on numerical simulation programs by FEM can be found in Herrera (2011).

This way, tools such as ANSYS ©, ABAQUS © or SOLIDWORKS ©, use finite elements and constitutive models adapted in a greater or lesser extent to reproduce reinforced concrete behavior. However, in general, material models in finite elements calculation tools implement generic constitutive material models. Thus, to be used, a value has to be assigned to the different parameters that govern equations according to the properties of the concrete to be modeled. This implies that the model should be calibrated from zero in its different behavior states, so at times it is necessary to configure complex curves with some uncertainty degree. This situation hinders material adjustment to the final result, because the knowledge to do that is not always available.

Considering the presence of these complications for the definition of the characteristic properties of concrete, adapted to generic material models, other tools are available which are specifically designed for concrete elements modeling. This is the case of the ATENA © commercial tool, developed by Červenka Consulting (Czech Republic), and designed as a finite element calculation software for the nonlinear analysis of reinforced concrete.

This tool offers the possibility to use constitutive models which allows to auto-complete values based in the desired compression strength. From this point, the remaining values are completed as established in the characteristics described in Eurocode 2 (2004). Prominent among these models is the CC3DNonLin Cementitious2, which reproduces concrete behavior assuming a hardening regime prior to reaching the compressive stress (Červenka et al. 2014a). In this way, the ATENA tool allows simulating actual conventional concrete and reinforced concrete structures behavior in a simple manner, including important parameters such as concrete cracking, crushing and stresses in reinforcements.

## 2 Objectives

In this context, the aim of this communication is to show the different experiments performed with the ATENA tool at the Escuela Técnica Superior de Ingenieros Agrónomos y Montes de Albacete (ETSIAM) over different linear concrete structural elements. Thus, analyses are performed over (a) reinforced elements, (b) pre-stressed elements, and (c) recycled concrete elements; these results being compared with experimental actual tests. This allows to contrast and caliber the tool response in different situations.

## 3 Methodology and Case Studies

### 3.1 Tool and Models Common Description

In order to analyze the different circumstances of elements subjected to bending that are presented in this communication, global configuration patterns are used which allow to analyze the different elements in their entire deformation regime up until the breaking point is reached. Hereafter, the fundamental characteristics of the materials, the border conditions and the analysis configuration are described:

### 3.1.1 Materials

- **CONCRETE.**

As the constitutive model for concrete, the CC3DNonLinCementitious2 model is used. This constitutive model, which belongs to the tool, reproduces the concrete's nonlinear behavior, assuming a hardening regime prior to reaching the compressive stress, and it is based on the failure mechanisms of plastic fracture, combining constitutive models for tensile behavior (fracture) and compression behavior (plastic).

The configuration of the model parameters is conducted as a function of the corresponding resistance classes in the experimentation, among those described in Eurocode 2. Subsequently, the principal model parameters are adjusted: compression strength ( $f_c$ ), tensile strength ( $f_t$ ), secant elasticity modulus ( $E_c$ ), fracture energy ( $G_f$ ) and deformation to the highest peak compression ( $\epsilon_{cp}$ ).

- **REINFORCEMENT.**

The reinforcement model used is made following the embedded bar elements approximation and the adherence model described in Jendele y Cervenka (2006). This model is integrated in the tool for its configuration. Thus, this model is applied to line elements, which are crossed by the volumetric finite elements corresponding to concrete. Element definition for each reinforcement is described by means of the basic parameters such as bar diameter ( $\emptyset$ ), steel strength ( $f_{yd}$ ) and elasticity modulus ( $E$ ), among others that define its behavior, as the bar type (corrugated or cable) or the bar adherence conditions.

- **STEEL IN AUXILIARY ELEMENTS.**

Where concrete elements suffer direct actions, in the analysis small load plates are installed to avoid stress concentration over an element node. These elements that lack analytic interest are modeled using a linear-elastic material model with an elasticity modulus of 210000 MPa.

### 3.1.2 Analysis Configuration

The simulation is configured so the analysis will obtain the complete load-deflection pattern, which allows characterizing the beam behavior to be compared with the one obtained in the experimental analysis. This way, the simulation does not apply a load increase as such, but an evolution of the analysis is configured, by applying a prescribed deformation in those points where the load is applied. This allows simulating a test in which displacement is controlled. This way, data is obtained relative to the complete evolution of the beam behavior, even after attaining plasticizing of the reinforcements or concrete softening.

This load situation through predetermined displacements instead of load steps allows using the Newton-Raphson classic resolution method and obtaining the complete solution for the analyzed element behavior, even after attaining its

maximum strength level. After those points the load is not increasing, yet the beam still shows certain resistance.

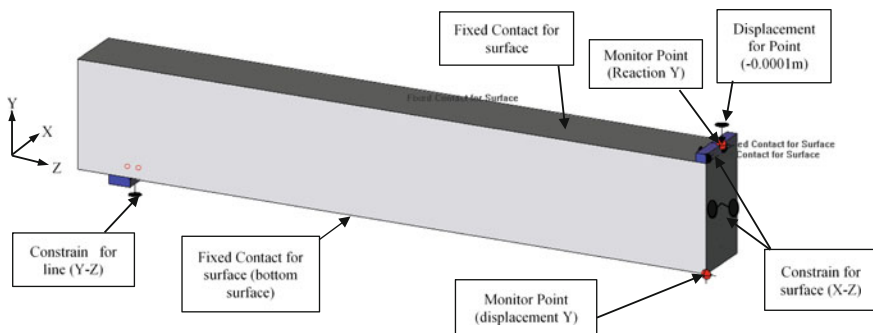
In order to obtain stresses and displacements, the ATENA tool allows using punctual information elements called Monitoring Points, which, for each load step, collect the desired information. In this occasion, two monitoring points are used: the reaction in the load application point and the deformation in the beam center.

As border conditions, conventional restrains are used, applied in the finite element analysis. In this case, a displacement restraint is applied in the support point, a symmetry restriction in the center of the span and contact restrains between steel auxiliary elements and concrete. All volumes here displayed are meshed using hexahedral elements. Also, every reinforcement bar is meshed in a unique linear element. Configuration of the entire analysis can be seen in Fig. 1.

### 3.2 Reinforced Concrete Beams

In the case of reinforced concrete beams, the model MEF response is compared with the obtained situation in experiments, in this case reinforced concrete beams analyzed by Bosco and Debenardi (1993). The aim of these analyses is to use these experimental results to assess if the proposed constitutive method is able to properly reproduce the different failure modes that can be produced in beams with different reinforcement quantities. That is to say, if it is able to reproduce correctly, the transition between the breaking of the reinforcement and the failure of concrete by compression. This reinforced beam analysis, as well as other elements subjected to compression can be found in more detail in Červenka et al. (2014b).

In beams with a low quantity of reinforcement, strength as well as rotational capacity is mainly determined by the elastic resistant capacity of the trusses and their critical elongation until break occurs. Meanwhile, in beams with a high quantity of reinforcement these properties are controlled by the capacity of the



**Fig. 1** Analysis conditions for a standard symmetric beam

**Table 1** Geometry of the analyzed beams (Bosco and Debenardi 1993)

Beam	H	B	L	c	c'	Tension reinforcement	Compression reinforcement	Stirrups diam/spacing
T-1	200	100	2000	24	22	1 Ø 12	1 Ø 8	Ø 6/150
T-2	200	100	2000	24	22	2 Ø 12	2 Ø 8	Ø 6/150
T-3	200	100	2000	24	22	3 Ø 12	2 Ø 8	Ø 6/150
T-8	600	300	6000	35	70	2 Ø 12	2 Ø 12	Ø 6/150
T-9	600	300	6000	35	70	4 Ø 12	2 Ø 12	Ø 6/150
T-10	600	300	6000	35	70	9 Ø 12	2 Ø 12	Ø 6/150
T-11	600	300	6000	35	70	18 Ø 12	2 Ø 12	Ø 6/150

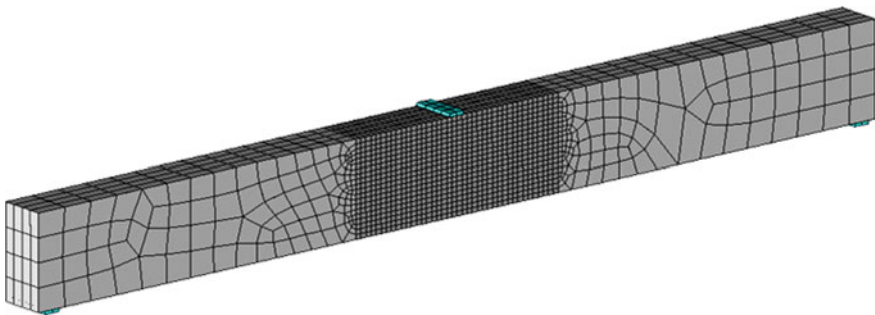
\*All measures in mm

compressed section to absorb compressive deformations without a significant softening of the concrete.

Two beams with different dimensions are analyzed: small beams with dimensions  $100 \times 200 \times 2000$  mm and bigger beams with dimensions  $300 \times 600 \times 6000$  mm. For each of these beam sizes, different reinforcement quantities were analyzed in order to assess the mentioned transition in the failure mode. Table 1 shows the geometric configuration and the characteristics of the analyses performed.

This way, a finite element analysis was configured in ATENA to simulate a three point bending test in accordance to the material models, the border conditions and the simulation configuration earlier described. The modeling of each beam is done through a typical mesh with hexahedral elements, with an element size of 30 mm in the central zone for both beam sizes (Fig. 2).

The characteristic parameters of the model material were: Elasticity (22000 MPa); Poisson coefficient (0.2); compression strength (27.8 MPa), tensile strength (2.2 MPa); deformation up to the peak compression point (0.000933 mm/mm); Fracture Energy (55.0 N/m); Beta coeff. (0.5) and Wd parameter (2.5 mm).

**Fig. 2** Example of mesh for beams T8, T9, T10 y T11

In particular, for these tests two similar analysis types were used to study the tool behavior when the configuration is symmetric. This allows reducing in half the element number in the model and boost calculation velocity, but it can come with sensibility losses in the analysis, especially in the zone near the breaking point.

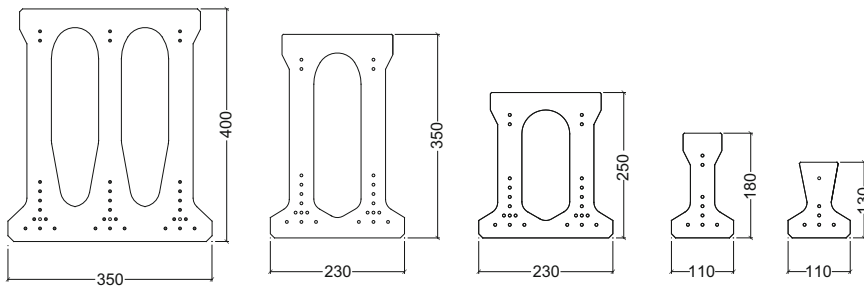
### 3.3 Pre-stressed Concrete Beams

In pre-stressed concrete beams, the ATENA tool is used to study this program's response for element simulation in pre-stressed reinforcements. This is done in order to calibrate the structural response of the element catalog used by any company specialized in prefabricated units. The aim of this analysis is to optimize the resistance characterization of the elements when a classical resistance calculation is performed, and to give answers to the new more resistant structural elements which are highly demanded.

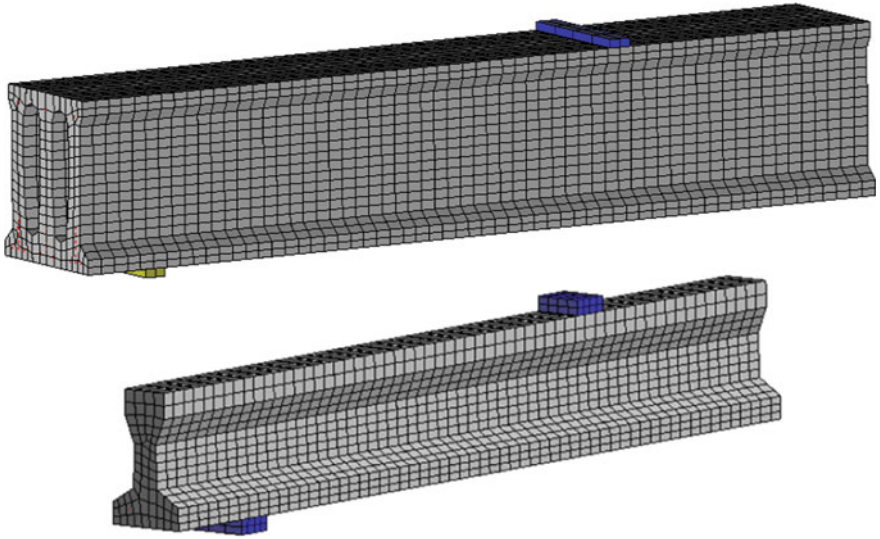
In this case, experimental analyses are performed by the authors, with samples with different resistant sections (simple and double joists), with different pre-stressed amounts and different lengths (between 1.80 and 5 m). Figure 3 shows the section of some of the analyzed typologies.

The analysis configuration is done using four points load tests with displacement control in the load application points. Moreover, following the above mentioned description, beams are symmetric with respect to the span center, so only half of the element is analyzed. Figure 4 shows models for two of these elements.

Materials selected for the model correspond to characteristics defined by the manufacturer for concrete and steel. Using these characteristics, governing parameters for the constitutive model of each material are generated. For example, concrete corresponds to a typology C45–55 according to the resistant properties from Eurocode 2, while steel corresponds to type Y1860C steel. Concrete compressive strength and steel tensile strength have been adjusted to those obtained in the material characterization tests ( $f_{ck} = 40 \text{ N/mm}^2$  and  $f_{yk} = 1667 \text{ N/mm}^2$ ).



**Fig. 3** Sections used in the experimental analysis and the simulation



**Fig. 4** 3D model of the simulated pre-stressed beams (alveolate beam and simple joist)

Specifically for this analysis, the pre-stressing effect is analyzed, as well as the way to incorporate it to the simulation model. Thus, pre-stressing is incorporated by establishing a border condition prior to the beginning of the load state, through a prescribed deformation corresponding to an initial tensional state of  $1275 \text{ N/mm}^2$ . To transform this value to the deformation condition, a steel elastic modulus of  $E = 210.000 \text{ N/mm}^2$  has been considered. It is worth emphasizing that in this process a pre-stressing loss coincident with the manufacturer estimations shown in its technical sheet has been considered. This way, it can be compared to the classical calculation corresponding to these elements, and also to the experimental results.

To compare the analysis and calibration of the models for each simulated element using the finite element method, different experimental bending tests are performed in order to determine the characteristic behavior of the actual element. These tests are performed in the Construction and Geotechnical Laboratory in the E. T.S.I. Agrónomos y Montes on Albacete which has a self-supporting frame of 500 kN for bending test of linear elements with a length up to 5 meters. The geometric configuration of these tests is identical to the configuration of each analysis. Thus, load is applied using displacement control. In these tests, load and displacement measurements occurring in the central point are taken in order to construct the load-deflection diagram up to the breaking point. Additionally, characterization of cracks obtained by high resolution video is performed. This allows obtaining a cracking pattern to be later compared with the analysis results.

### 3.4 Recycled Concrete Beams

An innovative alternative was addressed using this finite element simulation tool to study the adaptation of these models to the bending behavior of the recycled concrete reinforced beams. The special characteristics that recycled concrete confers to the bending behavior of reinforced beams when compared with conventional concrete can be resumed as higher deformation on the beam's central zone for the same load state, as well as a lesser cracking load. The maximum bending load of these elements made with recycled concrete can be considered similar to those made of conventional concrete (Sato et al. 2007; Malešev et al. 2010).

Adaptation to this behavior is addressed with the incorporation of different modifications on the material model, which allow to reproduce a similar structural response to the expected constitutive model response. To this end, the experiment work made by Sato et al. (2007) is used. Sato performs bending analysis in beam elements both of conventional and recycled concrete, and they compare these results in different curing environments to observe resistant capacity evolution differences.

Taking into account these experimental constraints, the finite element analysis is performed on beams with D13 quantities (two  $\varnothing$  13 mm reinforcements). The analyzed concretes are a control concrete (CC) and a recycled concrete (RC) with a 100% substitution rate, with two different manufacturing states according to their curing conditions: saturation conditions (humid) and laboratory conditions (dry). Four analyses were performed corresponding to the two concrete types in their two curing environments with the characteristics shown in Table 2. Reinforcement bars characteristics are  $f_{yd} = 353 \text{ N/mm}^2$  and  $E = 193.2 \text{ GPa}$ .

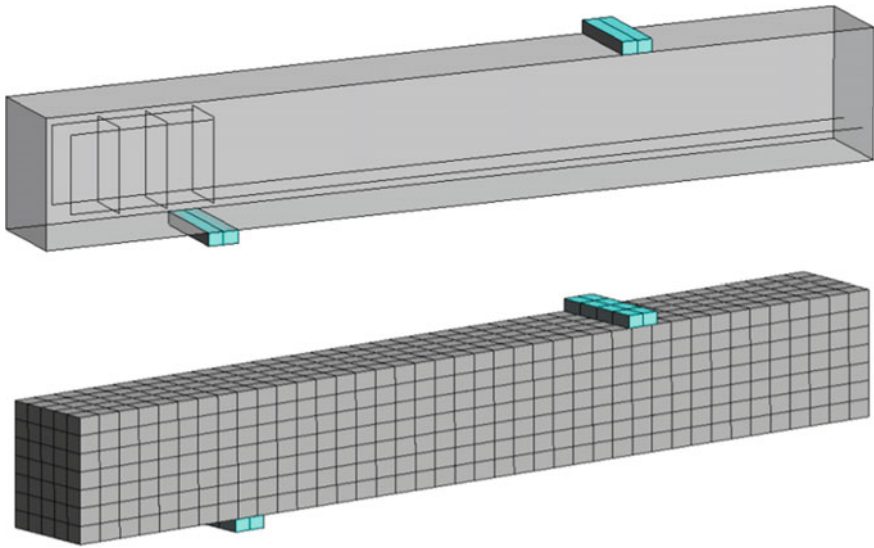
In this case, the analysis is performed through the modeling of half beam  $150 \text{ mm} \times 200 \text{ mm} \times 1400 \text{ mm}$ , meshed with hexahedral elements forming a total of  $5 \times 7 \times 40$  elements (1400). Sizes of these elements are ranging between 28 and 35 mm, and an axial-symmetrical restriction is applied at the central point. Figure 5 shows a diagram with the modeled solid and subsequent meshing generated with hexahedral elements.

The structural response obtained in the tests for each one of the recycled concrete and conventional concrete beam pairs is different; varying with the kind of

**Table 2** Resistant characteristics of concretes used in Sato et al. (2007)

Parameter	CC wet	CC dry	HC wet	HC dry
Compressive strength $f_c$ (MPa)	30.6	32.5	23.5	23.5
Tensile strength $f_t$ (MPa)	2.9	3.0	2.3	2.0
Elasticity modulus $E_c$ (MPa)	22,000	22,000	16,500	16,500
Poisson coef $\nu$	0.2	0.2	0.2	0.2
Fracture Energy $G_f$ (MN/m)	$4.5 \times 10^{-5}$	$4.5 \times 10^{-5}$	$4.5 \times 10^{-5}$	$4.5 \times 10^{-5}$





**Fig. 5** Model and meshing in ATENA to simulate beam tested by Sato et al. (2007)

environment in which the curing has been performed. However, the differences in resistant properties are minimal between the two specimens and thus the material model is not capable of reproducing these differences shown by the experiments. This situation has made necessary to add an additional calibration, which allows producing the extraordinary deformation observed in the dry environment cured elements.

Thus, to obtain these differences in simulation, two actions have been undertaken:

- The maximum aggregated size ( $D$ ) configured in the material model has been reduced. This hypothesis is derived from the fact that the recycled aggregate is a configuration of original aggregate and adhered mortar paste. Thus, sizes  $D = 25-15-10$  and  $5$  mm are analyzed.
- An initial volumetric contraction was applied, to simulate the shrinkage produced by drying, on the concrete cured in dry environment. By means of calibration, a volumetric strain has been introduced as an initial boundary condition. This volumetric deformation is introduced in all volume directions with the following values (mm/mm):  $0$  (without retraction),  $-0.00025$ ;  $-0.00038$ ,  $-0.00050$ ,  $-0.00065$ .

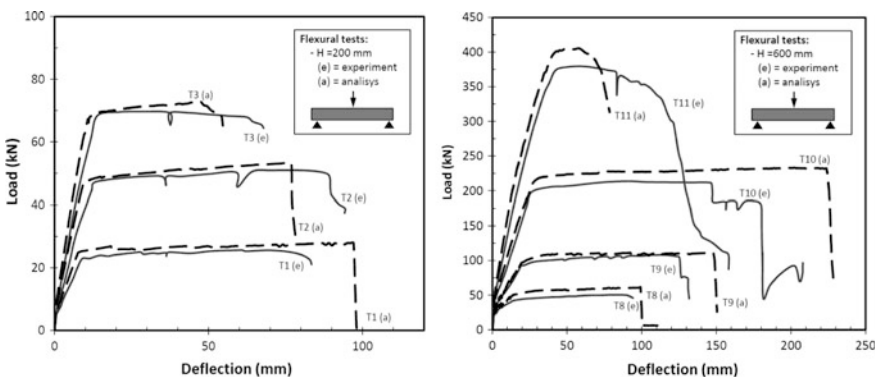
## 4 Results

The main results obtained in the analysis are shown below for each one of the performed experiences.

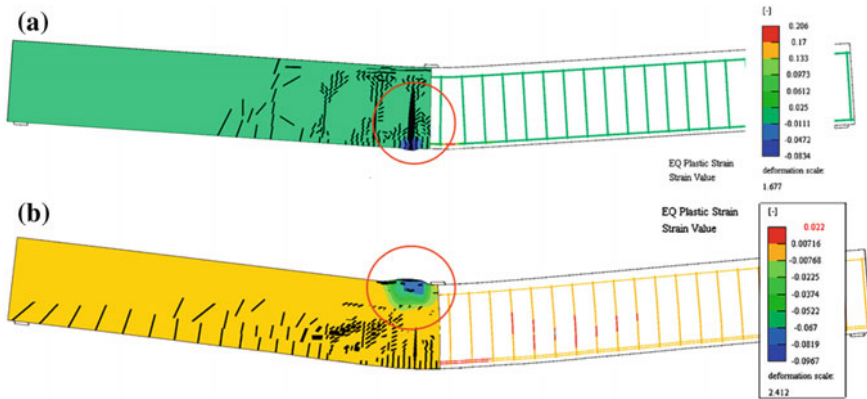
### 4.1 Reinforced Concrete Beams

The load-deflection analysis results, both from the analysis and the experimentation performed by Bosco and Debenardi (1993) are shown in Fig. 6. From these results it can be concluded that the model response to different reinforcement situations and in different geometric configurations shows an adequate enough adjustment. Thus, it can be observed that the model is capable of reproducing transition between fractured beams due to traction in the trusses and concrete compression failure in both situations.

The model with beams, which have a low amount of reinforcement (T1, T2, T8, T9 y T10) results in a rupture failure of the trusses (Fig. 7a). In the case of beams with a high amount of reinforcement (T3 y T11), the analysis shows concrete failure by compression in the zone near the supports (Fig. 7b). Thus, it can be concluded that the tool allows obtaining approximate enough results when compared with the actual situation regarding the beams' failure mode and the behavior of the configuring elements due to the reinforcement quantity. Significant differences have not been found in these analyses, regarding the response obtained with the complete models or the models analyzed by symmetry.



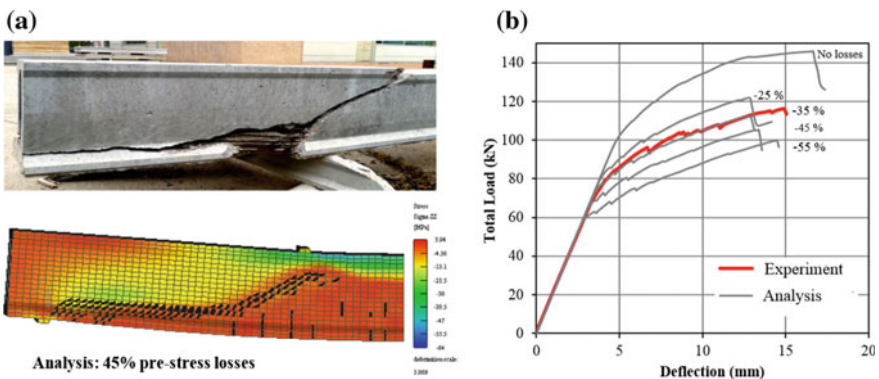
**Fig. 6** Analysis-experimentation comparative of the load-deflection diagrams for beams with  $H = 200$  mm (left) and  $H = 600$  mm (right) of Bosco and Debenardi (1993). (Červenka et al. 2014b)



**Fig. 7** Fracture simulation in beams with low amount of reinforcement (a) and high amount of reinforcement (b) (Bosco and Debenardi 1993)

### 4.2 Pre-stressed Concrete Beams

The pre-stressed concrete beams analysis is an ongoing experimentation. The research team is working on this phase at the moment, so the analysis for element calibration is in its evolution stage. However, the first results show very significant data regarding the adaptation of the analyses to the experimental results. Figure 8 shows the correspondence between experimental and simulation results where it is clearly observed how the progress of the fracture that generates element failure clearly coincides in both cases. Moreover, similarity between the resistant parameters obtained in both cases, allows to consider that the model's result is very adequate to the actual response of the different elements.



**Fig. 8** Comparative analysis-experimentation of the fracture process for the simulation with 45% pre-stress losses (a) and load-deflection diagrams for different loss degree applied to the model for the same element (b)

The first results from this comparative allow to conclude that one of the most important parameters that must be controlled when a simulation is performed is the pre-stress loss quantity applied to the model. Thus, Fig. 8b shows an example of the pre-stress force on the simulation. As can be observed, when pre-stress losses increase the beam response varies significantly, so the best simulation model, when compared with the experimental results, has been achieved for a losses level of 45%. This losses level is almost double the estimated level in the classical calculation, which is between 20–25%.

These results indicate that it is necessary to reflect on the actual pre-stress level obtained on the analyzed elements, achieved after the truss relaxation once concrete is hardened. If the model conditions needed to be capable of adjusting to the experimental test results reflect the actual element behavior, it is very important to assess the main cause of this considerable loss level. This is the focus of a new experimental series on elements, which are similar to those tested on the following sections, to assess:

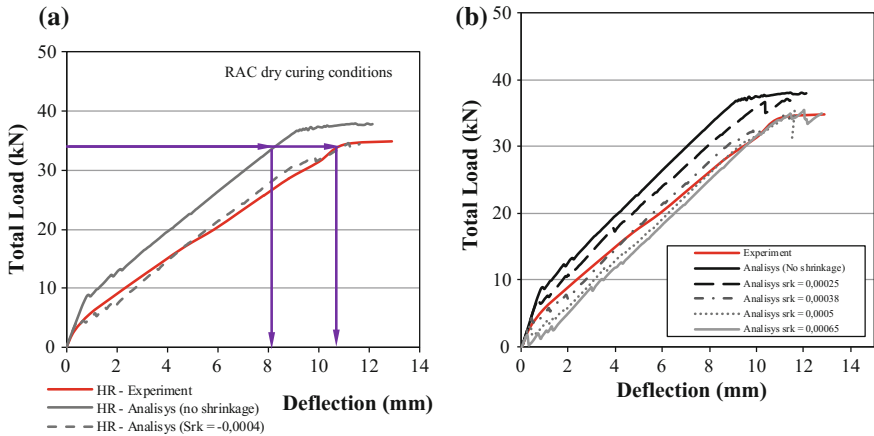
- Excessive pre-stress losses at the time of manufacture, possibly due to:
  - Too short concrete setting time.
  - Existence of some elements which reduce adherence between steel and concrete.
- Pre-stress losses due to a considerable evolution of the element life time.

In spite of this, and due to the fact that a more accurate mean of calibration regarding the pre-stress losses is not available to be applied to each case, the model is considered very suitable to establish resistant levels of the precast concrete components in the actual industry.

### ***4.3 Recycled Concrete Beams***

Regarding the results obtained for the recycled concrete beams, it can be stated that when models are applied to the simulation of reinforced recycled concrete, it is imperative to take into account the shrinkage produced by the element cure in the modeling using ATENA. Figure 9a shows the results for one of these recycled concrete dry environment cured beams and how the analysis corresponding to a non-shrinkage model is not well adjusted to the analysis results (dashed lines).

However, when a volumetric contraction corresponding to the shrinkage effect is introduced, the simulation response shows a cracking load drop and a deflection increase for the same load state. Thus, the application of a volumetric contraction effect of  $-0.0004$  mm/mm allows for an analysis response along the load-deflection curve, which perfectly approximates the one obtained by Sato et al. (2007). Additionally, Fig. 9b shows the influence of different volumetric contractions, which simulate the corresponding shrinkage states on the load-deflection response.



**Fig. 9** Simulation results for the recycled concrete beams, cured in dry (a) and humid (b) environment

As can be observed, as the shrinkage applied to the element is higher, the model shows a proportional cracking load drop as well as a deflection increase, showing a more ductile response when compared to the tested element.

Additionally, the different performed analyses show that this behavior of the recycled elements is not only observed when the cure process is made in a dry environment. Even when the element has been cured in high humidity conditions it is necessary to introduce some retraction level (although it will be lower than the one used when the element is dry cured), in order to adapt the model response to the experimental situation. This situation does not occur in the conventional concrete simulation, where the obtained response with the resistant experimental data of the element cured in humid conditions (or without shrinkage) perfectly reproduces the obtained result. Thus, the main conclusion of these analyses is that in order to reproduce the recycled concrete response, regardless of its curing environment, it is advisable to introduce a previous state to the volumetric contraction load in order to simulate the fact that the recycled concrete shows more shrinkage than the conventional concrete.

The calibration of these models have been performed by comparing the simulation with the results stated in Sato et al. (2007), so the entire information is not available to perform a generalized model adjustment and to stablish recommendations to be used by a third analyst. Thus, the next step would be to perform a series of experimental tests with recycled concrete beams, with different amounts of recycled material (0, 50 y 100%), different reinforcement amounts (low reinforcement and high reinforcement), two different curing environments (dry and humid) and two concrete strengths (HA-25 y HA-45). These tests will have the aim of broadening the analysis casuistry to the possible situations that can be found with this material and to produce a guidebook for analysts interested in performing simulations on recycled concrete elements subjected to bending loads.

## 5 Conclusions

The main conclusions that can be extracted from the comparative of these analyses with the different experimental situations are:

- The results obtained by the models in the simulation of the various beams subjected to bending loads are very good adapted to the available experimental results with which they have been compared. Thus, it is possible to use the ATENA tool for the simulation of this type of elements with a high degree of adjustment to reality, in reinforced, pre-stressed and recycled concrete elements.
- In the case of conventional concrete reinforced beams, the model response has shown perfect adaptation to the different fracture modes (reinforcements tensile or concrete compression) that occur in beams with different reinforcement quantities and for different element sizes.
- In the case of pre-stressed beams, the model response when compared with the experimental tests has been calibrated with a high degree of adjustment. However, it has been necessary to apply a pre-stress loss percentage higher than the one obtained by calculation. For this reason, an additional experimentation has been proposed with the aim to assess the reason and the real amounts of these losses, so generic conclusions with regard to simulation adjustments can be reached.
- Regarding the reinforced recycled concrete elements analysis, the constitutive model is not capable by itself to reproduce the lower cracking load and the higher deformation for the same load state, when compared with the conventional concrete elements. However, this factor can be compensated and with very good results, by applying a restriction to the concrete volume, in order to simulate the significant shrinkage that the recycled concrete undergoes during the curing process.

**Acknowledgements** This work was performed under the research project “Valorización de áridos reciclados procedentes de residuos de la construcción y demolición y su utilización en la construcción de infraestructuras rurales (PPII-2014-004-P) and co-financed by Junta de Comunidades de Castilla-La Mancha (Spain) and Fondo Social Europeo. We acknowledge the collaborating entities for their assistance with this research: SYTECA S.L., CEMENTOS PORTLAND VALDERRIBAS, ALMACENES CANO BARRAX S.L. & TRIALSA EIFFAGE INFRAESTRUCTURAS.

## References

- Bosco C, Debenardi PG (1993) Influence of some basic parameters on the plastic rotation of reinforced elements. Ductility requirements for structural Concrete – Reinforcement. Comité Eurointernational du Breton. CEB Bull 218:25–44
- Červenka V, Jendele L, Červenka J (2014a) ATENA Program Documentation. Part 1. Theory. Červenka Consulting s.r.o. [http://www.cervenka.cz/assets/files/atena-pdf/ATENA\\_Theory.pdf](http://www.cervenka.cz/assets/files/atena-pdf/ATENA_Theory.pdf)

- Červenka V, Červenka J, Laserna S (2014b) On finite element modelling of compressive failure in brittle materials. *Computational Modelling on Concrete Structures*. Euro-C 2014. pp 273–281. Ed Bićanić et al. Taylor y Francais Gropu, London. ISBN: 978-1-138-00145-9
- Eurocódigo 2: Design of Concrete Structures (2004) Part 1-1: General Rules and Rules for Buildings (EN 1992-1-1). European Committe for Standarization (CEN). Brussels, Belgium
- Herrera LA (2011) Modelación Numérica del Concreto Simple con Elementos Finitos Usando un Modelo Constitutivo de Daño. Universidad Nacional de Colombia, Departamento de Ingeniería Civil y Agrícola. Bogotá DC
- Isenberg J (1991) Finite element analysis of reinforced concrete structures II. Committee on Finite Element Analysis of Reinforced Concrete Structures. American Society of Civil Engineers
- Jendele L, Cervenka J (2006) Modelling Bar Reinforcement with Finite Bond. *Comput Struct* 84:1780–1791
- Karpenkoa N, Karpenkob S, Petrovc A et al (2015) Incremental approach to the nonlinear analysis of reinforcement concrete with cracks at plane stress state. *Procedia Eng* 111:386–389
- Malešev M, Radonjanin V, Marinković S (2010) Recycled concrete as aggregate for structural concrete production. *Sustainability* 2:1204–1225
- Meyer C, Okamura H (1985) Finite element analysis of reinforced concrete structures. In: *Proceedings of the US-Japan joint seminar on finite element analysis of reinforced concrete*, Tokyo, Japan
- Mihai I, Jefferson A, Lyons P (2016) A plastic-damage constitutive model for the finite element analysis of fibre reinforced concrete. *Eng Fract Mech* 159:35–62
- Nilson AH (1972) Internal measurement of bond slip. *J ACI* 69(7):439–441
- Sato R, Maruyama I, Sogabe T et al (2007) Flexural behavior of reinforced recycled concrete beams. *J Adv Concrete Technol* 5(1):43–61

**Part III**  
**Product and Process Engineering and**  
**Industrial Design**



# Study on Optimization of the Tuna-Fishing Vessel Construction Project, Through Production Oriented Design



C. Mascaraque-Ramírez, L. Para-González and D. Moreno-Sánchez

**Abstract** Presently, new shipbuilding projects are conditioned by a globalization frame that requires increasingly demanding competitiveness in delivery times and costs. For this reason, it is necessary to continuously study improvement and optimization proposals, both of the vessel project and also of the shipyard facilities. This work exposes a number of improvements focused on two main paths, production oriented design and the restructuring of the shipyard workshops and facilities. It will be shown that with a proper standardization of the components in the design phase, a reduction of their purchase costs is achieved. An improvement of the learning curve of the staff in charge of the assembly and maintenance is also achieved, reducing, as a result, delivery times and labor costs. Furthermore, plant distribution techniques and other Quality Management methodologies applied to production will be analyzed. Their application will allow optimizing workshop facilities and shipyard resources, thus reducing processing times and even diversify new lines of business.

**Keywords** Optimization · Standardization · Production oriented design  
Shipbuilding projects

---

C. Mascaraque-Ramírez (✉) · D. Moreno-Sánchez

Faculty of Naval and Oceanic Engineering, Naval Architecture Technology Department,  
Technical University of Cartagena, Paseo Alfonso XIII, 52, 30203 Cartagena, Spain  
e-mail: carlos.mascaraque@upct.es

L. Para-González

Economics and Juridical Sciences Department, University Centre of Defence at the Spanish  
Air Force Academy, C/Coronel López Peña s/n, 30720 Santiago de la Ribera (Murcia), Spain  
e-mail: lorena.para@tud.upct.es

## 1 Introduction

New ships building industry is currently concerned about globalization. In particular, the European shipbuilding has to compete with the Asian industry, which manages 80% of the worldwide order backlog. By ship-builder country and according to Lloyds-Fairplay (Lloyds-Register 2015), China occupies the first international position, with 34% of all contracts, leaving the second place to South Korea with 29.5% of all contracts and almost half the contract share that this country had in 2011; in third position is Japan with 18.4%. European contracts are further behind, with an 8% of the total. Nonetheless, Europe has recovered some tenths of the market share, in spite of reducing its absolute contract volume in the last year.

The first European country by contract volume has been Germany (29%), followed by Rumania (19%). For their part, Italy and Spain had in 2012 the third and fourth market share of the EU, with a contract share of 11% and 10% respectively.

Chinese shipyards have concentrated their efforts in offering clients low prices and irresistible financing plans. Sometimes they ask only for 10% of the total contract cost as down payment leaving the other 90% to be paid on delivery. At this point, quality, the ships' energy efficiency and complying with delivery dates are of the utmost importance and Chinese shipyards have a notorious deficit in this matter, although their high production volume makes the learning curve very steep in time.

For their part, European shipyards have great difficulties competing with Asian shipyards, which build cheaper ships because they have lower costs, higher production and cheap labor costs, allowing South Korea, for instance, to sell its ships at prices lower than the European production costs. This way, European shipyards cannot make offers by reducing their benefit margins, and the only option they have is to sell under losses and to depend on national or community subsidies. In this situation, China and South Korea increasingly absorb more orders and they already control 70% of the world market. The low prices that the Korean companies offer to ship owners, have allowed taking almost all the work orders from community countries. Spain, as Germany and Italy, is one of the most affected countries, due to this situation.

In big figures, between 2009 and the present, vessel construction represents in Spain an annual production capacity of more than 390,000 CGT (Compensated Gross Tons). This unit is a measurement of the compensated gross tonnage, related to the gross tons by using a compensation coefficient for each ship type and size. It takes into consideration the construction complexity, on the base of the work hours necessary for its manufacture. Spain directly employs around 8,000 workers (3,000 in private shipyards and 5,000 in public shipyards). It also creates another 17,000 jobs in the auxiliary industry.

## 2 Objectives

This research proposes different measures to reduce delivery times and costs in the construction project of a tuna-fishing vessel. It also aims at achieving that the Spanish and European shipyards, which are dedicated to the manufacture of this type of vessels, become more competitive in the present international context and may be able to subsist without community aids.

Since it is not possible to compete in financing conditions or in the labor hourly costs, this study focus must be in the reduction on delivery times and in cost reductions (Ahsan and Gunawan 2010; De Snoo et al. 2011). The costs to be reduced are the ship main materials acquisition costs, that is, the steel sheets and the equipment and components that will be installed on board.

## 3 Methodology and Case Study

This study considers a tuna freezer vessel projected for fish of tuna using the purse-seine fishing system in the fishing grounds of the Atlantic, Indian and Pacific Oceans. It is a sturdy but light vessel, with energy and propulsive efficiency. It has 16 (non-structural) self-supporting barrels for tuna freezing and conservation. Fish catches will be frozen in the barrels using the immersion in brine system, and the tuna will be subsequently conserved freeze dried in those barrels.

The main characteristics of the vessel studied are shown in Table 1:

In order to improve construction times and to reduce costs, the study has been divided in two branches: the first one will be devoted to production oriented design and the second one to shipyard facilities restructuring, with the aim of optimizing them for construction of this type of vessels.

**Table 1** Main characteristics of the tuna freezer vessel

Concept	Value
Overall length	87.00 m
Length between perpendiculars	74.40 m
Molded breadth	14.20 m
Hold depth to upper deck	9.05 m
Hold depth to lower deck	6.55 m
Mean draught	6.30 m
Estimated gross tonnage	2,570 cgt
Water freezing barrels	1750 m <sup>3</sup>
Fuel capacity (approx.)	720 m <sup>3</sup>
Fresh water capacity (approx.)	60 m <sup>3</sup>
Lubricant oil capacity (approx.)	45 m <sup>3</sup>
Dead weight	2230 t
Full load test velocity	17.5 Kn

Source Elaborated by authors (2016)

### 3.1 *Production Oriented Design*

In this stage, the aim is to optimize the project in its design phase (Eyres and Bruce 2012), focusing the study on two main objectives: the first one, is ship scantling optimization, that is to be centered in the thickness of the steel sheets that constitute the main structure of the ship's hull. The second one, is the ship components and equipment standardization.

#### 3.1.1 **Hull Structure Optimization**

The steel structure of the ship's hull is one of the more expensive project concepts. In conventional projects, the classic design standards are followed, as defined by the main classification societies (Alvariño-Castro et al. 1997). In the last decade, more powerful software introduction for sheet thickness calculation has led to search for minimum scantling that comply with safety standards and are thick enough to ensure a stable structure in all conditions. In this research work, sheet optimization is proposed, not only looking for the minimum thickness of each sheet, but also minimizing the total number of different sheet thickness used in the project.

For scantling determination, the structure calculation application Nauticus Hull, of the Norwegian classification society DNV (Det Norske Veritas) has been used. The Nauticus Hull is a software which allows to evaluate the vessel structural strength, offering all the necessary tools for the hull efficient design and the verification, according to common structural rules for bulk carriers, oil tankers, fishing ships and other types of vessels (Det-Norske-Veritas 2008).

Figure 1 shows typical thickness of a conventional tuna freezer.

Working with this software, it is possible to optimize the structure in ideal conditions of minimum thickness, obtaining the structure shown in Fig. 2.

The situation showed in Fig. 2 meets the structural conditions without a safety margin, so thickness has to be increased to comply with these margins. In this phase, not only thickness increase is analyzed to meet safety coefficients, but also thickness standardization is also sought, to notably reduce the thickness catalogue used in construction, arriving to the situation shown in Fig. 3.

This standardization work achieves a reduction of the number of used thickness, from 4 thickness types (7, 8, 9 and 13.5 mm) to 2 thickness types (7 and 13.5 mm), meeting at all times with the ship structural requirements.

The same exercise has been made with the structural profiles used in construction. A reduction was achieved in a similar proportion for the profile types used for longitudinal and transversal reinforcements.

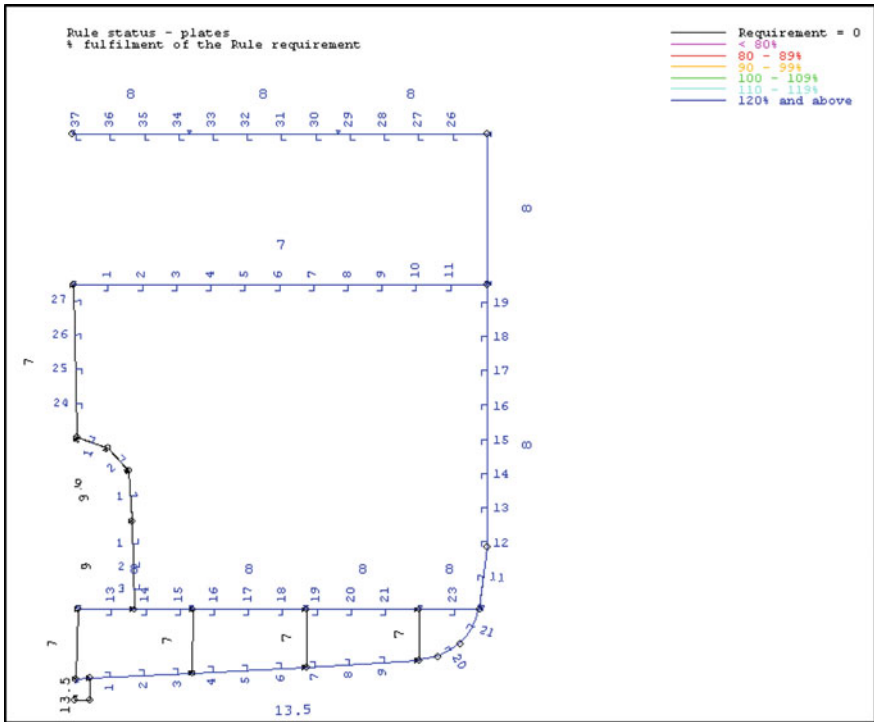


Fig. 1 Initial situation of the vessel scantling. Source Elaborated by the authors using the Nauticus Hull (2016)

### 3.1.2 Components and Equipment Standardization

As with the vessel hull, equipments that are part of the ship facilities are designed to minimize their size and requirements. As a consequence, the chosen equipment are those with lower costs that comply with the requirements of the facility to which they must provide service (Eyres and Bruce 2012). In this study, not only equipment optimization is proposed following the above stated orientation, but also it will aim to minimize the number of different equipments the project will comprise and to reduce as much as possible the number of suppliers to work with.

In this aspect, it is essential to focus in reducing the number of suppliers, because it is a key element to achieve final costs reduction. In standardizing components, the first step will probably be to enhance the characteristics of some of them. Consequently, in a first iteration the total equipment cost may appear to have increased, but by increasing the purchase volume to the same supplier, two immediate saving strategies will appear: the first one, consists in negotiating better equipment acquisition conditions, due to a greater commitment between the suppliers and the shipyard. The second one, will lead to internal costs reduction in

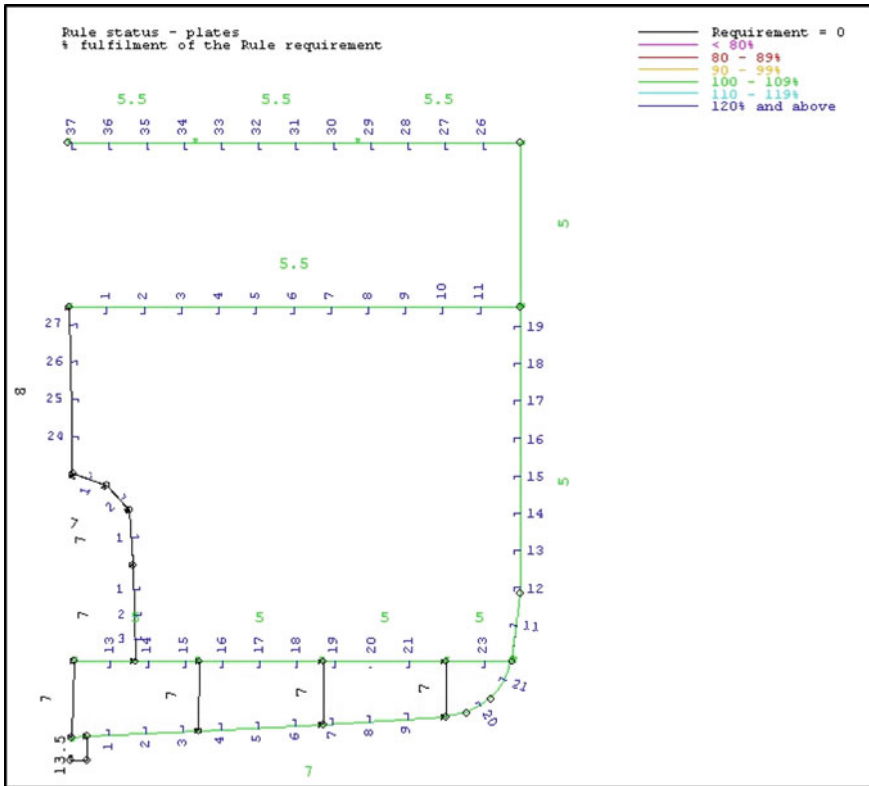


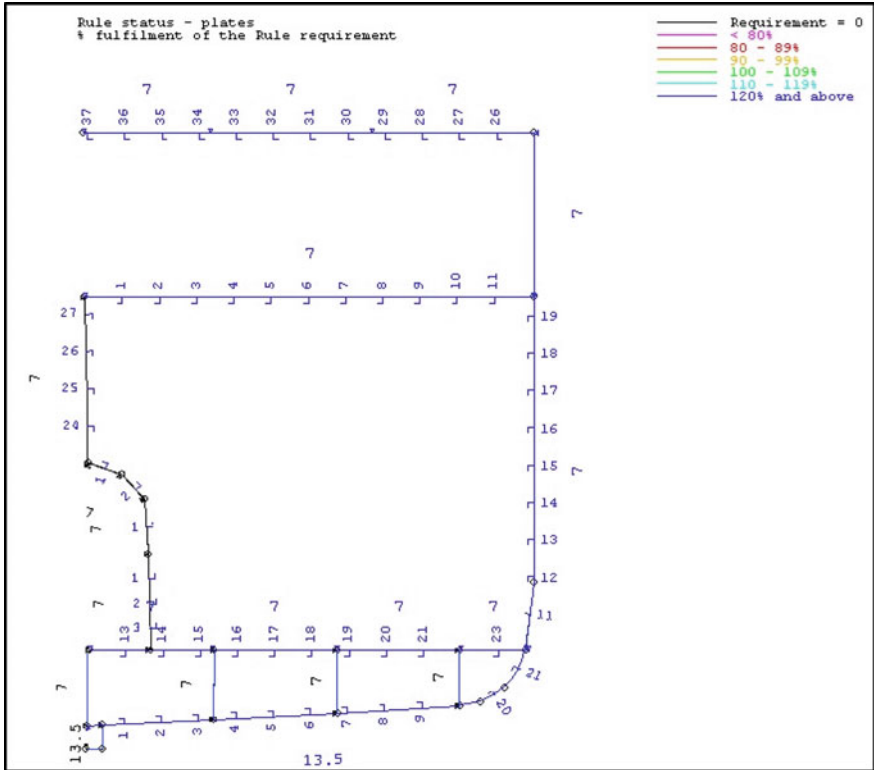
Fig. 2 Minimum thickness situation for the vessel. Source Elaborated by authors using the Nauticus Hull (2016)

suppliers management, having to work with a fewer number of them (Kapurch 2010).

Reduction of material typologies will allow stock reduction and will minimize delay risks in equipment reception. For instance, the same equipment is to be installed in a greater number of facilities, and hence, if reception of some equipment is delayed, the work could be continued using those in stock. If the proposed standardization is not applied, a unique equipment will serve the facility and if it is not in stock, work will be delayed thus affecting the planned schedule (Clark 2003).

This research is aimed at the standardization of the equipment listed in Table 2, where cost and number of equipment types in the initial situation and the standardized situation are shown.

As it can be observed, the initial results show a 6.5% increase of the initial acquisition costs, without taking into account improvement in negotiations and purchase management costs reduction. On the other hand, materials typology decreases from 32 to 26; hence a reduction close to 20% in equipment types to be purchased and installed is achieved.



**Fig. 3** Thickness standardization situation for vessel scantling. *Source* Elaborated by the authors using the Nauticus Hull (2016)

**Table 2** Equipment variation due to standardization

Concept	Initial cost (€)	Typology	Standardized cost (€)	Typology
Motors	9,900	2	9,900	2
Electric power generators	403,225	2	438,412	1
Diesel power generators	5,718	1	5,718	1
Electric pumps	24,469	5	24,684	4
Pumps	93,781	8	95,537	6
Electric fans	13,719	5	15,278	4
Compressors	8,830	2	8,830	2
Fuel purifiers	25,400	1	25,400	1
Lighting	3,484	6	3,126	5
Total	588,526	32	626,885	26

*Source* Elaborated by authors (2016)

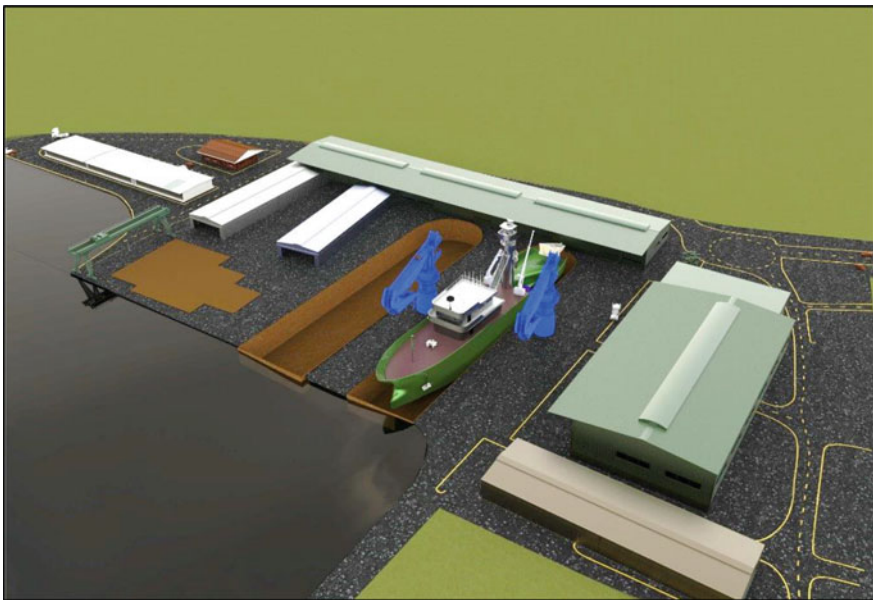
### 3.2 Shipyard Workshops and Facilities Restructuring

Parallel to the vessel design project optimization, work has been done in the restructuring of the typical facilities of a new tuna fishing construction shipyard. This research is focused in production process improvement, in unproductive movements reduction of the products under construction, in workshops layout to adapt it to the manufacture of large blocks and dock hall usage time minimization for each vessel (Project-Management-Institute 2014, Eyres and Bruce 2012).

Figure 4 shows the characteristic layout of a construction shipyard with two dock halls, with the studied ship in dock hall 1.

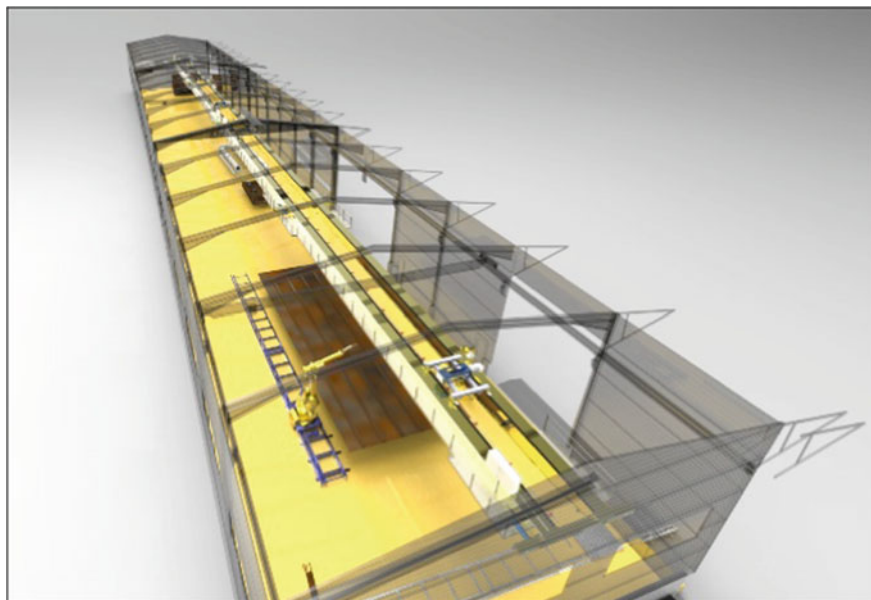
In this figure, the U-shaped distribution used can be seen, which begins in the sheets reception park, following the block forming workshops (Fig. 5), to the right of the large block assembling workshop (Fig. 6) and ending in the central zone with the 2 big dock halls.

Classic distribution of this type of shipyard is based on guilds, separating the block welding section, the pipeline construction section, the minor structures construction zone, etc. In this study, Lean Manufacturing techniques have been used, thus offering a more competitive alternative. Continuous and tight flow of intermediate products generated by the different workshops allows for an immediate reduction of intermediate stock costs and manufacturing times.

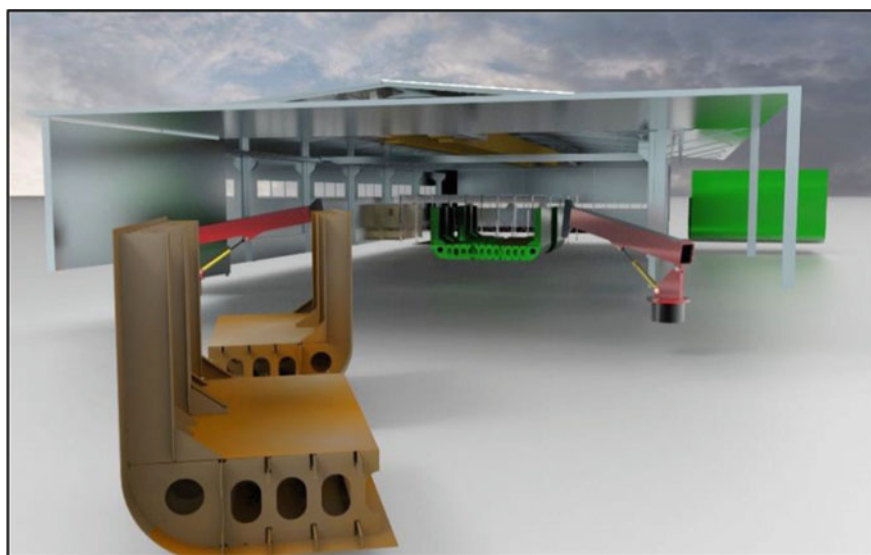


**Fig. 4** 3D view of the shipyard layout. *Source* Elaborated by the authors (2016)





**Fig. 5** Block forming workshop. *Source* Elaborated by authors (2016)



**Fig. 6** Block assembling workshop. *Source* Elaborated by authors (2016)

Inside the workshops, a lineal distribution is used, where the product increases its construction degree until it reaches the next process stage. In Fig. 5, the example of the block forming workshop is shown.

Design and manufacture based in the large block concept allow for block construction in the same workshops, as shown in Fig. 6. By working in the workshops, the work is made in best conditions (Eyres and Bruce 2012), and it translates in an increase in work quality, a decrease in construction times and defects, and thus a decrease in reprocessing.

## 4 Results

Analysis of the data obtained in previous sections allows focusing results on these research objectives, separating them in two categories: those obtained by production-oriented design and those resulting from facilities restructuring.

### 4.1 Results Obtained in Design

The redesign phase of the ship hull has been concluded with sheet thickness standardization, reducing the number of sheet thickness needed from 4 to only 2 thickness types. Moreover, the hull has been optimized by reducing the required steel total weight and consequently, its cost. Results are shown in Table 3.

A decrease of 9% of steel weight and cost can be observed, which represents a direct reduction in steel purchase and a decrease the vessel operation costs due to its reduced weight.

Regarding components standardization, Table 4 resumes the main advantages and disadvantages detected during the execution of the proposed standardization.

Finally, it can be determined that the advantages outweigh the disadvantages. Specifically, analyzing the main disadvantages, the 6.5% initial cost increase will be reduced during the negotiations with the suppliers, because cost reductions can be obtained when a greater purchase volume is negotiated with only one supplier. The reduction in purchase management costs, as a consequence of dealing with a smaller number of suppliers will also impact this initial cost increase.

**Table 3** Weight and cost comparative in the hull optimization process

	Initial situation	Proposed situation	Difference	Difference (%)
Steel cubic meters	97 m <sup>3</sup>	89 m <sup>3</sup>	8 m <sup>3</sup>	8
Steel total weight	764 t	699 t	65 t	9
Steel total cost	305 K€	279 K€	26 K€	9

Source Elaborated by authors (2016)

**Table 4** Ship equipment standardization advantages and disadvantages

Advantages	Disadvantages
<ul style="list-style-type: none"> <li>• 20% reduction in the equipment typology number to be used</li> </ul>	<ul style="list-style-type: none"> <li>• Higher unit price of the equipment to be used</li> </ul>
<ul style="list-style-type: none"> <li>• Comparable reduction in the suppliers' number to be contracted. This produces a decrease in the shipyard purchase management</li> </ul>	<ul style="list-style-type: none"> <li>• 6.5% initial increase in equipment acquisition cost</li> </ul>
<ul style="list-style-type: none"> <li>• Possibility to improve equipment purchase conditions with the supplier, due to the acquisition volume agreed with the same supplier</li> </ul>	
<ul style="list-style-type: none"> <li>• Improvement in the learning curve of the operators assigned to equipment assembly</li> </ul>	
<ul style="list-style-type: none"> <li>• Improvement in the learning curve of sailors operating the ship during its life cycle</li> </ul>	

Source Elaborated by authors (2016)

The higher unitary cost can be an inconvenience, if individual elements have to be purchased to substitute some equipment throughout the construction or the life cycle. Nonetheless, the advantage of reducing assembly times due to a higher operator specialized knowledge about the equipment to be assembled counters this inconvenience. It can also be extrapolated to the life cycle, which is an advantage for the person who operates the ship.

## 4.2 Results Obtained on the Facilities Restructuring

The study on shipyard facilities restructuring produces three clearly positive results for the company. The first one is the reduction in manufacturing times for each vessel, by optimizing workshops and using a better layout for each one of them. Also, with the use of a shipyard U distribution, manufacturing time is reduced for each intermediate product and time spent in material movements is also reduced.

The second advantage is the reduction of construction time in the dock hall. This time is more costly and technically difficult than the construction in the workshop (Alvariño-Castro et al. 1997; Eyres and Bruce 2012), so all the work produced in workshops is cheaper than that performed in the dock hall.

Finally, and as a third advantage, reducing dock hall usage times generate opportunity advantages in their use for other business lines of the shipyard. In Fig. 7, an indicative plan for the construction of a series of 3 tuna fishing vessels are presented. Here it can be observed that 3 windows of opportunity open for the use of one of the dock halls, which can be used, for example, for ships repair.

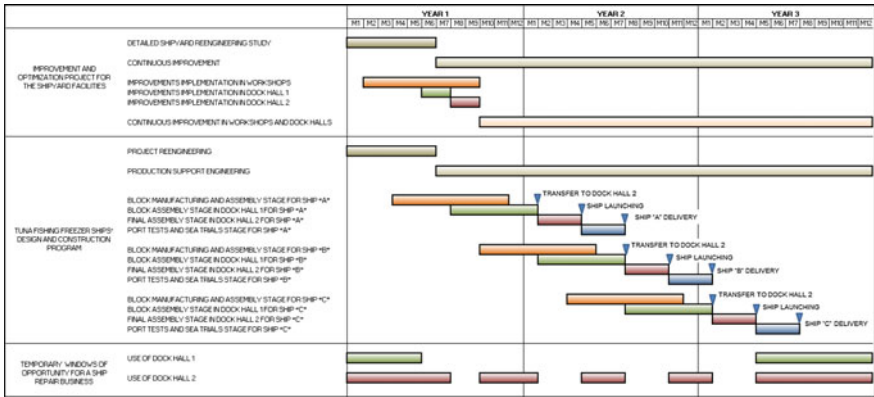


Fig. 7 Construction plan for a series of 3 vessels. Source Elaborated by authors (2016)

## 5 Conclusions

In this investigation, production oriented design and standardization concepts are used and developed to achieve a competitiveness improvement of the European shipbuilding industry in the international markets. This improvement is focused in the tuna freezer ships new construction project.

To this end, production improvement concepts by means of Lean Manufacturing have been used. Also, the U-shaped layout has been used with the aim of optimizing shipyards facilities in order to reduce times and costs. Furthermore, diversification opportunities have been identified in the business lines that emerge from the reduction in the dock hall usage. This is due to a higher percentage of assembly in the workshops for the new vessels and to the manufacturing of large modules.

Obtained results show a relevant improvement in direct construction costs, specifically regarding steel and equipment acquisition for the ship. Moreover, together with the facilities restructuring, a reduction in execution times is achieved. This reduction also produces a cost decrease by reducing delivery times as well as work hours and production required auxiliary services.

## References

Ahsan K, Gunawan I (2010) Analysis of cost and schedule performance of international development projects. *Int J Proj Manag* 28:68–78. <https://doi.org/10.1016/j.ijproman.2009.03.005>

Alvaríño-Castro R, Azpíroz-Azpíroz JJ, Meizoso-Fernández M (1997) *El proyecto básico del buque mercante*. Fondo Editorial de Ingeniería Naval, Madrid, Spain

Clark AR (2003) Optimization approximations for capacity constrained material requirements planning. *Int J Prod Econ* 84:115–131. [https://doi.org/10.1016/S0925-5273\(02\)00400-0](https://doi.org/10.1016/S0925-5273(02)00400-0)

- De Snoo C, Van Wezel W, Jorna RJ (2011) An empirical investigation of scheduling performance criteria. *J Oper Manag* 29:181–193. <https://doi.org/10.1016/j.jom.2010.12.006>
- Det-Norske-Veritas (2008) Nauticus Hull - User Manual. PULS, Høvik, Norway
- Eyres DJ, Bruce GJ (2012) Ship construction. Butterworth-Heinemann
- Kapurch SJ (2010) NASA systems engineering handbook. DIANE Publishing Company, Washington, DC, USA
- Lloyds-Register (2015) IHS fairplay register of ships 2015–2016. IHS Global Incorporated, Redhill, United Kingdom
- Project-Management-Institute (2014) A guide to the project management body of knowledge (PMBOK Guides). Project Management Institute, Newtown Square, Pennsylvania

# A Critical Evaluation of Cathode Materials for Lithium-Ion Electric Vehicle Batteries



Robert Reinhardt, B. Amante García, Lluç Canals Casals  
and S. Gassó Domingo

**Keywords** Electric vehicle · Lithium-ion · Battery · Cathode

## 1 Introduction

For more than 20 years, lithium-ion batteries (LIBs) have been the predominant power source of choice for portable consumer electronics such as mobile phones and laptops as they offer higher energy densities and longer lifespans compared to other rechargeable battery systems (Tarascon and Armand 2001; Deng 2015). In recent years, LIBs have been increasingly applied to electric vehicles (EVs) and stationary storage for electricity produced by renewable sources such as wind and solar. Although LIBs have been successful on a commercial scale, in the context of EVs, there are still major challenges that must be addressed with regards to material costs, environmental impacts, cycle life, safety, energy and power that are all directly related to the selected combination of battery materials (Dinger et al. 2010). In particular, there are issues around EV limited driving ranges and high costs of present commercially installed lithium-ion battery packs (Bonges and Lusk 2016). Hence the EV industry presently desires an augmentation of capacity and power, increase in the battery's lifetime and dramatically reduced battery pack costs.

---

R. Reinhardt (✉) · B. Amante García · S. Gassó Domingo  
Department of Project and Construction Engineering,  
Universitat Politècnica de Catalunya, Carrer de Colom 11, 08222 Terrassa, Spain  
e-mail: robert.reinhardt@upc.edu

B. Amante García  
e-mail: beatriz.amante@upc.edu

S. Gassó Domingo  
e-mail: santiago.gasso@upc.edu

L. Canals Casals  
Energy System Analytics Group, Institut de Recerca en Energia de Catalunya,  
Jardins de les Dones de Negre 1, 2 pl., 08930 Sant Adrià de Besòs, Spain  
e-mail: lcanals@irec.cat

Besides this, as EVs have null tailpipe emissions that can substantially help fight issues around pollution, one might conclude that they represent a full scale prospective sustainable transport solution. In fact, during EV manufacturing processes the environmental impact is higher than that of internal combustion engine vehicles (ICEVs), with the battery production phase contributing significantly to emitted greenhouse gases (GHG) (Notter et al. 2010). This is why there has been continuous research focus on all material aspects of LIBs such as electrodes, electrolyte and separator (Armand and Tarascon 2008; Whittingham 2008; Amine et al. 2014). In particular, the limited theoretical capacity and thermodynamics of the available cathode material in a typical LIB is a critical component with regards to the working voltage, energy density, rate capability and battery cost (Xu et al. 2013). In previous years, the primary research focus has been on cathode material cost reductions as it costs nearly twice as much as the anode material and has the highest weight of all materials within a typical LIB (Gaines and Cuenca 2000; Whittingham 2008). Besides this, the gravimetric capacity of common cathode materials is one-half that of anode materials (Whittingham 2004). Furthermore, cathode materials are a critical factor of energy density within a LIB, as it has a lower specific capacity than the most common anode material, graphite (372 mAh/g), to which it must be matched.

All these considerations led to the development of several types of cathode materials as so far there is not one ideal material that can meet requirements for all applications while being economical and environmentally sound at the same time. Consequently, the objective of this study is to evaluate present commercially available cathode materials for LIBs in EVs from an economic and environmental perspective.

## 2 Methodology

This study makes use of a three level approach whereby first of all, the characteristics of common cathode materials for LIBs are categorized and subsequently this knowledge is used to assess economic and environmental implications. Finally, proposed economical and environmentally sound cathode materials are compared with lithium-ion battery packs that are commercially available in EV models today.

At the first level, present common cathode materials for LIBs are identified and their characteristics are summarized with respect to their specific energy and power, cycle life, voltage and commercial applications. Data were collected from selected available literature on LIBs and are summarized in Table 1. It is necessary to differentiate and comprehend that LIB technologies incorporate a variety of alternative chemistries (e.g.  $\text{LiFePO}_4$ ,  $\text{LiMn}_2\text{O}_4$ ), electrode designs, different shapes (pouch, cylindrical, prismatic) and capacities of the individual cells that make up the pack; depending on the potential combination, there is a direct impact on performance, weight, costs and degradation rates (Sakti et al. 2015).

At the second level, the previously identified cathode materials are analyzed and compared under economic and environmental perspectives. At the economic

**Table 1** Existing literature on cathode materials in lithium-ion batteries

Reference	Research focus
[1] (Deng 2015)	Basics, progresses and challenges of LIBs
[2] (Liu et al. 2015)	Electrochemical potentials of cathode materials for LIBs
[3] (Amirault et al. 2009)	Electric vehicle battery landscape: LIB state of the art
[4] (Dinger et al. 2010)	Batteries for electric vehicles: outlook 2020
[5](Nitta et al. 2015)	LIB materials: present and future scenarios
[6] (Lu et al. 2013)	Review on key issues of LIB management in electric vehicles
[7](Huat et al. 2015)	Integration issues of LIB into electric vehicle battery pack
[8] (Nelson et al. 2011)	Modelling the performance and cost of LIB for EVs
[9] (Hakimian et al. 2015)	Economic analysis of LIB manufacturing processes
[10] (Casals et al. 2015)	LIB materials degradation and environmental impact
[11] (Scrosati and Garche 2010)	Lithium batteries: status, prospects and future
[12] (Xu et al. 2012)	Recent progress in cathode materials research for LIBs
[13] (Etacheri et al. 2011)	Challenges in the development of advanced LIBs
[14] (Amine et al. 2014)	Progress, challenges and future direction of LIBs
[15](Thackeray et al. 2012)	Electrical energy storage for transportation
[16] (Goodenough and Park 2013)	The lithium-ion rechargeable battery: a perspective
[17] (Armand and Tarascon 2008)	Building better batteries
[18] (Manthiram 2011)	Materials challenges and opportunities for LIBs
[19] (Whittingham 2008)	Materials challenges facing electrical energy storage
[20] (Whittingham 2004)	Lithium-ion batteries and cathode materials

perspective, this study evaluates cathode material cost data from two well-established cost evaluations models, Battery Performance and Cost model (BatPac) and the PHEV cost assessment study (TIAX), as presented in Table 2 (Barnett et al. 2010; Nelson et al. 2011). The BatPac model studies cell and component masses, pack-level performance with previously modelled cell chemistries and delivers a determination of cost versus performance characteristics (Nelson et al. 2011).

**Table 2** Details of stated costs for cathode materials in lithium-ion batteries

Cathode Material	Abbreviation	Unit	BatPac 2010	TIAX 2010 <sup>1</sup>	TIAX 2013 <sup>1</sup>
Phospho-olivine	LFP	\$/kg	20	15-20-25	15-18-20
Manganese spinel	LMO	\$/kg	10	12-16-20	12-16-20
Layered oxide	NCA	\$/kg	33	34-40-54	36-40-48
Layered oxide	NMC	\$/kg	31	40-45-53	33-36-45

<sup>1</sup>Cost represents range of values possible

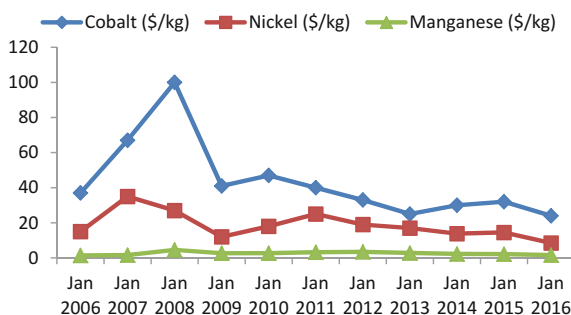


The TIAX study on the other hand examines the manufacturing costs of battery packs for PHEVs whereby the major focus lies on the material selection trade-offs and power/energy optimization and capacity fade effects (Barnett et al. 2010). Both studies are evaluating costs of common cathode materials lithium iron phosphate (LFP), lithium manganese oxide (LMO), lithium nickel manganese cobalt oxide (NMC), and lithium nickel cobalt aluminum oxide (NCA). Furthermore, the fluctuations of historical raw material prices (Fig. 1) are perceived in both studies.

The BatPac model uses a co-precipitation of Nickel, Manganese and/or Cobalt based off a correlation with Cobalt 44 \$/kg and the TIAX study applies average traded metal prices of the last 25 years with 95% confidence intervals of Cobalt  $44.4 \pm 18.3$  \$/kg and Nickel  $14.9 \pm 7.6$  \$/kg (Barnett et al. 2010; Nelson et al. 2011). Both studies use different input data for their cost models such as pack energy requirements, power input/output, production volumes, battery chemistries, material performance and fluctuations in raw material prices. Hence, this study determines the average cost for each cathode material based on cost data from both studies. In 2013, TIAX published a revised study with updated cost data for the raw materials Cobalt and Nickel according to their trading prices between 2011–2012, respectively  $31 \pm 5$  \$/kg and  $20.5 \pm 4.5$  \$/kg (Rempel et al. 2013). Thus, the average cathode material costs are calculated using identical cost data from the BatPac model, but substituting the TIAX cost values from 2010 with their updated data from 2013. The results of the calculated average costs for each cathode material under both scenarios are put in a graph and their implications are evaluated in Sect. 3.1.

From the environmental perspective, the key parameter of discussion is on greenhouse gas (GHG) emissions during battery manufacturing processes as the emitted CO<sub>2</sub> levels during EV production currently outweigh internal combustion engine vehicle (ICEV) production emissions (Nealer et al. 2015). The majority of the emitted GHG result from battery manufacturing processes, of which the selected cathode material composition used for a desired LIBs contributes significantly; consequently, data on CO<sub>2</sub> emissions of the cathode materials LFP, LMO and NMC were collected from available life-cycle-analysis (LCA) studies and are discussed in Sect. 3.2 (Majeau-Bettez et al. 2011; Frischknecht 2011; Notter et al. 2010). Data on emitted CO<sub>2</sub> levels and energy flows of all four commercially available cathode

**Fig. 1** Historical 10-year prices (2006–2016) of Cobalt, Nickel and Manganese



materials following the same equations are scarce and thus subject to uncertainties. This is why the presented results should therefore be interpreted as an estimation of emissions.

At the third level, the evaluated economic and environmentally sound cathode materials for LIBs are compared to cathode materials in LIBs for commercial EVs. As the battery technology and hence the price and overall performance of a vehicle is the key selling point of any EV manufacturer, data on specific cathode material compositions in commercial EVs are generally not published by EV companies and were therefore collected from scientific journals. Consequently, the discussion aims to critically analyze which cathode materials are preferred amongst key industry players and how this affects overall vehicle performance and sustainable competitive advantage within the emerging EV industry.

### 3 Cathode Materials

In LIBs, the most common cathode materials are lithium cobalt oxide (LCO), LFP, LMO, NCA and NMC, as presented in Table 3. The key requirements for cathode materials for LIBs are a high free energy of reaction with lithium as well as an integration of large volumes of lithium (Deng 2015). The first commercially available cathode material, LCO, was successfully introduced in 1991 due to the material's high specific energy (150–200 Wh/kg) (Armand and Tarascon 2008). EV manufacturer Tesla used LCO batteries within their early Tesla Roadster model but soon switched to more stable chemistries due to low capacity, toxicity, poor safety and high cost of LCO (Amirault et al. 2009). As a result of these risks, LCO became undesirable for applications in EVs and global battery manufacturers have since opted for enhanced cheaper and safer cathode materials for EVs.

**Table 3** Characteristics of commercially available cathode materials in lithium-ion batteries

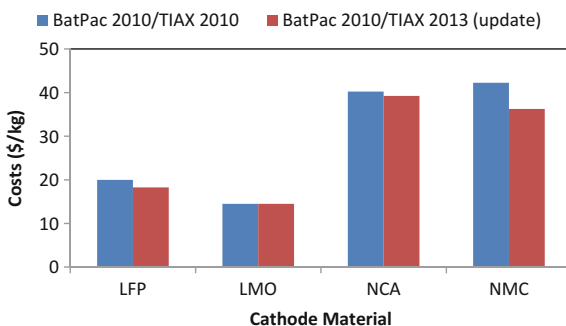
Cathode	LiCoO <sub>2</sub>	LiFePO <sub>4</sub>	LiMn <sub>2</sub> O <sub>4</sub>	LiNiMnCoO <sub>2</sub>	LiNiCoAlO <sub>2</sub>
Abbreviation	LCO	LFP	LMO	NMC	NCA
Anode	Graphite				
Type	Metal Oxides				
Specific energy (Wh/kg)	150–200	80–120	100–130	160–220	180–250
Cycle life	300–500	1000–2000	300–700	1000–1500	500
Voltage (V)	3.6	3.2/3.3	3.7	3.6/3.7	3.6
Applications	Consumer electronics, power tools, electric powertrains, medical devices				
References	[1–11]	[2–13]	[3–11, 13]	[3–6]	[3–6]
	[14–20]	[15, 18–20]	[15, 18–20]	[7–14]	[9, 10, 15]

### 3.1 Economic Perspectives of Cathode Materials for EVs

Cost reductions in LIBs for EVs can be achieved first and foremost by substituting battery materials, economies of scale in the production process and/or through the establishment of new material supplies; in particular, the cost of cathode materials can be decreased either by material substitution or by finding ways to obtain the same materials at a lower cost (Gaines and Cuenca 2000). As cathode materials incorporate raw material transition metals such as Cobalt, Nickel and Manganese, of which some have shown substantial trading price inconsistencies over recent years, the price of specific battery materials are of some debate. In determining the average costs for the studied cathode materials, the results show that the impact of volatile raw material prices is evident, as presented in Fig. 2. Above all, the vast average price variances of the different cathode materials are apparent. The NCA/NMC cathodes cost on average about twice as much as LFP/LMO based LIBs, respectively 40.25/42.25 \$/kg and 20/14.5 \$/kg. This is due to the high contents of the expensive raw materials Cobalt and Nickel in the NCA/NMC based LIBs. The market price for Cobalt and Nickel has varied dramatically in the last 25 years and thus reducing the volumes in the cathode materials will lead to a decrease of overall cathode prices and less price volatilities. In fact, the market price for Cobalt and Nickel has substantially dropped since the BatPac and TIAX study were published in 2010, reaching a historical 10-year low in April 2016, with Cobalt trading for 22.50 \$/kg and Nickel for 8.28 \$/kg (Fig. 1). Hence, in evaluating the updated TIAX cathode material costs, which are based on raw materials prices between 2011–2012, it becomes evident that decreased raw material prices have a direct impact on final cathode costs (Fig. 2).

This resulted in moderate to high cost reductions for the NCA/NMC cathodes, declining by 1 \$/kg/6 \$/kg respectively. Furthermore, it is assumed that these reductions were also a result of economies of scale as NCA and NMC based LIBs have been increasingly applied to EVs due to their high operating voltage (3.6 V) and excellent specific energies, in that order 160–220 Wh/kg and 180–250 Wh/kg (Liu et al. 2015; Nitta et al. 2015).

**Fig. 2** Average costs of common cathode materials in lithium-ion batteries



The comparison of the LFP/LMO cathodes reveals that LFP is more cost extensive as a result of the increased complexity in the manufacturing process (e.g. carbon coating) to LMO, which is relatively easy to manufacture. Nevertheless, both cathodes include inexpensive earth abundant elements such as Iron and Manganese in comparison to the rare earth and expensive Cobalt and Nickel elements in NCA/NMC based LIBs.

Therefore, cathode materials based on abundant elements such as Manganese should be the prevailing transition metal if a low cathode material, and thus a cost-effective LIB, is desired. But, it must also be underlined that if EV manufacturers seek low-cost cathode materials, they have to reach a compromise between overall LIB pack cost and performance of the battery. This is underlined with the low-cost lithium manganese oxide cathode ( $\text{LiMn}_2\text{O}_4$ ) offering specific energy of 100–130 Wh/kg, in comparison to the high-cost lithium nickel cobalt aluminum oxide cathode ( $\text{LiNiCoAlO}_2$ ) with specific energy of 180–250 Wh/kg (Lu et al. 2013).

### 3.2 *Environmental Perspectives of Cathode Materials for EVs*

With regards to GHG during battery production processes, Aguirre et al. (2012) found that total battery electric vehicle (BEV) lifetime  $\text{CO}_2$  equivalent emissions accumulate to 31,821 kg  $\text{CO}_2$  equivalent, of which 24% are caused by battery manufacturing processes. Depending on the choice of materials, including the choice of cathode material, this directly affects emitted GHG, as presented in Table 4. It is evident that the cathode chemistries LMO/LFP are the most environmentally sound material choice with  $\text{CO}_2$  equivalent emissions of 52 kg/kWh and 166 kg/kWh compared to NMC based batteries with 200 kg/kWh. LFP achieved superior emissions to NMC due to the use of less environmental intensive materials (Majeau-Bettez et al. 2011). Kg  $\text{CO}_2$ -equivalent emissions for each cathode material chemistry is directly related to whether they include scarce and valuable raw materials such as Cobalt and to a lesser extent Nickel or earth abundant materials such as Manganese.

This is critical, as Nickel and/or Cobalt based cathode materials such as NMC/NCA, are becoming increasingly popular in EVs with no alternative more

**Table 4**  $\text{CO}_2$ -equivalent emissions of cathode material based lithium-ion battery production

References	$\text{CO}_2$ -equivalents kg/kWh battery	Cathode chemistry studied
(Notter et al. 2010)	52	LMO
(Frischknecht 2011)	134	Not specified
(Majeau-Bettez et al. 2011)	200	NMC
(Majeau-Bettez et al. 2011)	166	LFP

sustainable (not dependent on materials such as Cobalt) EV battery technology arriving at market soon, as further discussed in the next chapter.

Gaines and Nelson (2009) estimated cumulative demands of cathode materials needed by 2050 for light-duty EV LIBs in the United States (U.S.), on the world reserve bases (million tons) of Cobalt (13 million tons), Nickel (150 million tons) and Manganese (5,200 million tons). It was concluded that in order to meet 2050 demands, 9% of Cobalt, 4% of Nickel and 0.12% of Manganese world reserve bases are required. This is a critical issue because prospective EV adoption rates and the demand for critical raw materials such as Cobalt will accelerate simultaneously. Even though trading prices of Cobalt and Nickel are currently low, if the demand increases these metals will become gradually rarer and hence prices will increase radically. Further, EV LIB manufacturers are importing materials (e.g. Cobalt) from leading raw material suppliers such as Russia. All of these factors indicate that there must be more aggressive recycling efforts on critical materials such as Cobalt and Nickel, which are today often motivated merely by their high economic values with some degree of disregard of how to handle other non-valuable and toxic materials in an environmentally sound manner. However, a comprehensive discussion of recycling issues around cathode materials from LIBs is not in the scope of this study.

What stands in a direct relationship to GHG emissions of cathode material production, is the use of more renewable energies for the entire LIB production process as well for the EV use-phase (e.g. charging infrastructure). Both are strongly impacted by the electricity mix in a given country. This is further emphasized by Saevarsdottir et al. (2015) claiming that the electricity consumed during a typical LIB production process is decreased by 95–98% if production is moving away from less sustainable regions such as China to more sustainable energy countries such as Iceland where the electricity production causes a footprint of 18–23.5 g CO<sub>2</sub>/kWh.

Besides this, the in-use phase of EVs alongside a prospective uptake in sales on a global scale represents an important area for the power sector, as there will be additional electricity sales for utilities and an increased demand on the grid for charging infrastructures and related services. EVs can further serve as an energy storage channel in supplying power to utilities through smart grids ('Vehicle-to-Grid') by providing valuable services to the existing energy markets such as meet peak demands through selling the electricity from the battery while charging during off peak times. However, according to a study by the World Energy Council (2013), global total primary energy supply (by resource) will reach 17,208 million tons of oil equivalent by 2020, of which 76% originates from fossil fuels, 16% from renewables (other than large hydro), 2% from hydro (>10 megawatt) and 6% from nuclear sources. Without a doubt, this underlines that the full potential of overall energy efficiency still remains untapped, especially the vast economic and environmental opportunities associated with EVs.

### 3.3 The Commercial EV Battery Landscape

In the global automotive industry, leading EV manufacturers are currently using different cathode materials for their LIB systems whereby LMO, NMC and NCA are the predominant materials, as presented in Table 5. Recently, Navigant Research (2015) predicted that the global market for LIBs in light duty and medium/heavy duty vehicles will accelerate from \$7.8 billion in 2015 to \$30.6 billion in 2024, underlining that the emerging EV industry is currently undergoing an important economic transition.

In evaluating Table 5, the most popular cathode materials in commercial EVs are LMO and NMC, followed by NCA and LFP. It is evident that the choice of cathode material chemistry has a direct impact on total vehicle cost and driving range. The previously identified economical and environmentally sound cathode materials, LMO and to some extent LFP, are available in commercial EVs such as in the Nissan Leaf or Ford Focus Electric. The reason for the choice of these cathode materials is purely economic and less due to environmental concerns as a low cost vehicle towards consumers is desired. Nevertheless, the different cathode materials used in LIBs for EVs underline that there are trade-offs between total vehicle costs (price impact of cathode material) and desired driving ranges (overall performance of cathode material), as discussed previously.

Hence, most EV companies are currently selling their models at around \$30,000 but with limited driving ranges of about 120–140 km in order to attract potential new customers. On the other hand, there are also market players that have aimed at substantially increased EV driving ranges with higher costs such as BYD (E6 model) offering 200 km with total vehicle cost of \$52,000 and Tesla (Model S)

**Table 5** Cathode materials in selected commercial electric vehicles

Company	Model	EV Type	Cathode Material	Vehicle Cost (\$) <sup>1</sup>	Driving Range	References
Nissan	Leaf S	BEV	LMO	29,000	135	(Cluzel and Douglas 2012; Shen et al. 2015)
Tesla	Model S	BEV	NCA	70,000–109,000	335-435	(Lu et al. 2013; Nitta et al. 2015)
GM	Volt	PHEV	LMO	33,000	61	(Lu et al. 2013)
Ford	Focus electric	BEV	LMO	29,000	122	(Shen et al. 2015)
Fiat	Fiat 500	BEV	NMC	32,500	140	(Shen et al. 2015)
VW	E-Golf	BEV	NMC	29,000	134	(Shen et al. 2015)
BYD	E6	BEV	LFP	52,000	200	(Lu et al. 2013)
Renault	Zoe	BEV	NMC	25,000	210	(Shen et al. 2015)

<sup>1</sup>Vehicle costs based on commercial available electric vehicles on the U.S. market in 2016

offering up to 435 km driving ranges but with total vehicle cost of \$70,000–\$109,000. This may result in competitive advantages with respect to driving ranges within the industry but the high costs of such models can represent a barrier for potential customers, as switching costs from ICEVs towards EVs are already high.

## 4 Conclusions

This study highlights that the economic and environmental performance of commercially available cathode materials for LIBs directly impacts overall EV cost and performance. Both, at the economic and environmental perspective, LMO/LFP based LIBs perform superior compared to NCA/NMC cathodes due to the absence of the expensive and rare transition metals Cobalt and Nickel, that directly impact total cathode costs and CO<sub>2</sub> emissions during battery manufacturing processes.

However, this means that if low-cost cathodes are desired, overall EV performance will be reduced resulting in limited driving ranges. For this reason, EV companies currently have to reach a compromise between driving ranges, that are directly dependent on the overall performance of the cathode material, and affordable total vehicle cost, which relates to the choice and cost impact of cathode material and hence the total battery pack cost, towards their consumers.

So far, there is no battery that can satisfy both, economic and environmental concerns while offering an overall excellent performance. Nevertheless, the ongoing improvements on cathode materials in LIBs in the last two decades have provided one promising solution towards a low carbon future with a society that is less dependent on motorized vehicles.

**Acknowledgements** The authors would like to thank the Universitat Politècnica de Catalunya (UPC), the ReViBe project TEC2015-63899-C3-1-R funded by the Spanish government, the Ministerio de Economía y Competitividad y al Fondo Europeo de Desarrollo Regional (FEDER) TEC2015-63899-C3-1-R (MINECO/FEDER) and the scholarship program FI-DGR 2016 by Agència de Gestió de les Ajudes Unisersitàries i d'Investigació (AGAUR).

## References

- Aguirre K, Eisenhardt L, Lim C et al (2012) Lifecycle analysis comparison of a battery electric vehicle and a conventional gasoline vehicle <https://www.ioes.ucla.edu/project/lifecycle-analysis-comparison-of-a-battery-electric-vehicle-and-a-conventional-gasoline-vehicle/>. Accessed 24 Jan 2016
- Amine K, Kanno R, Tzeng Y (2014) Rechargeable lithium batteries and beyond: Progress, challenges, and future directions. *MRS Bull* 39:395–401. <https://doi.org/10.1557/mrs.2014.62>
- Amirault J, Chien J, Garg S et al (2009) The electric vehicle battery landscape : opportunities and challenges. [https://ikhlaqsidhu.files.wordpress.com/2010/03/nrelectricvehiclebatterylandscape\\_1221-1.pdf](https://ikhlaqsidhu.files.wordpress.com/2010/03/nrelectricvehiclebatterylandscape_1221-1.pdf). Accessed 12 Feb 2016

- Armand M, Tarascon J-M (2008) Building better batteries. *Nature* 451:652–657. <https://doi.org/10.1038/451652a>
- Barnett B, Rempel J, Ofer D et al (2010) PHEV battery cost assesment. [https://www1.eere.energy.gov/vehiclesandfuels/pdfs/merit\\_review\\_2010/electrochemical\\_storage/es001\\_barnett\\_2010\\_o.pdf](https://www1.eere.energy.gov/vehiclesandfuels/pdfs/merit_review_2010/electrochemical_storage/es001_barnett_2010_o.pdf). Accessed 19 Dec 2015
- Bonges HA, Lusk AC (2016) Addressing electric vehicle (EV) sales and range anxiety through parking layout, policy and regulation. *Transp Res Part A Policy Pract* 83:63–73. <https://doi.org/10.1016/j.tra.2015.09.011>
- Casals LC, García BA, Aguesse F, Iturrondobeitia A (2015) Second life of electric vehicle batteries: relation between materials degradation and environmental impact. *Int J Life Cycle Assess* 1–12. <https://doi.org/10.1007/s11367-015-0918-3>
- Cluzel C, Douglas C (2012) Cost and performance of EV batteries: final report for the committee on climate change. [http://www.element-energy.co.uk/wordpress/wp-content/uploads/2012/06/CCC-battery-cost\\_-\\_Element-Energy-report\\_March2012\\_Finalbis.pdf](http://www.element-energy.co.uk/wordpress/wp-content/uploads/2012/06/CCC-battery-cost_-_Element-Energy-report_March2012_Finalbis.pdf). Accessed 3 Jan 2016
- Deng D (2015) Li-ion batteries: basics, progress, and challenges. *Energy Sci Eng* 3:385–418. <https://doi.org/10.1002/ese3.95>
- Dinger A, Martin R, Mosquet X et al (2010) Batteries for electric cars - challenges, opportunities, and the outlook to 2020. <http://www.bcg.com/documents/file36615.pdf>. Accessed 27 Jan 2016
- Etacheri V, Marom R, Elazari R et al (2011) Challenges in the development of advanced Li-ion batteries: a review. *Energy Environ Sci* 4:3243–3262. <https://doi.org/10.1039/C1EE01598B>
- Frischknecht R (2011) Life cycle assessment of driving electric cars an scope dependent LCA models. In: 43. Ökobilanz-Diskussionsforum, Zürich: Switzerland
- Gaines L, Cuenca R (2000) Costs of lithium-ion batteries for vehicles. *Energy* 48:73. <https://doi.org/10.1002/art.10781>
- Gaines L, Nelson P (2009) Lithium Ion batteries: possible materials issues. Argonne National Laboratory, Argonne
- Goodenough JB, Park K-SS (2013) The Li-ion rechargeable battery: a perspective. *J Am Chem Soc* 135:1167–1176. <https://doi.org/10.1021/ja3091438>
- Hakimian a., Kamarthi S, Erbis S, et al (2015) Economic analysis of CNT lithium-ion battery manufacturing. *Environ Sci Nano* 2:463–476. <https://doi.org/10.1039/c5en00078e>
- Huat SL, Yonghuang Y, Tay AAO (2015) Integration issues of lithium-ion battery into electric vehicles battery pack. *J Clean Prod.* <https://doi.org/10.1016/j.jclepro.2015.11.011>
- Liu C, Neale ZG, Cao G (2015) Understanding electrochemical potentials of cathode materials in rechargeable batteries. *Mater Today* 19:109–123. <https://doi.org/10.1016/j.mattod.2015.10.009>
- Lu L, Han X, Li J et al (2013) A review on the key issues for lithium-ion battery management in electric vehicles. *J Power Sources* 226:272–288. <https://doi.org/10.1016/j.jpowsour.2012.10.060>
- Majeau-Bettez G, Hawkins TR, Stromman AH (2011) Life cycle environmental assessment of lithium-ion and nickel metal hydride batteries for plug-in hybrid and battery electric vehicles. *Environ Sci Technol* 45:4548–4554. <https://doi.org/10.1021/es103607c>
- Manthiram A (2011) Materials challenges and opportunities of lithium ion batteries. *J Phys Chem Lett* 2:176–184. <https://doi.org/10.1021/jz1015422>
- Navigant Research (2015) Advanced energy storage for automotive applications. <https://www.navigantresearch.com/research/advanced-energy-storage-for-automotive-applications>. Accessed 14 Jan 2016
- Nealer R, Reichmuth D, Anair D (2015) Cleaner cars from cradle to grave: how electric cars beat gasoline cars on lifetime global warming emissions. Union of Concerned Scientists, Cambridge (USA)
- Nelson PA, Gallagher KG, Bloom I, Dees DW (2011) modeling the performance and cost of lithium-ion batteries for electric-drive vehicles. 1–102. <https://doi.org/10.2172/1027714>
- Nitta N, Wu F, Lee JT, Yushin G (2015) Li-ion battery materials: present and future. *Mater Today* 18:252–264. <https://doi.org/10.1016/j.mattod.2014.10.040>



- Notter DA, Gauch M, Widmer R et al (2010) Contribution of Li-ion batteries to the environmental impact of electric vehicles. *Environ Sci Technol* 44:6550–6556. <https://doi.org/10.1021/es903729a>
- Rempel J, Barnett B, Hyung Y (2013) PHEV battery cost assessment. [https://www1.eere.energy.gov/vehiclesandfuels/pdfs/merit\\_review\\_2010/electrochemical\\_storage/es001\\_barnett\\_2010\\_o.pdf](https://www1.eere.energy.gov/vehiclesandfuels/pdfs/merit_review_2010/electrochemical_storage/es001_barnett_2010_o.pdf). Accessed 17 Dec 2015
- Saevarsdottir G, Tao P, Stefansson H, Harvey W (2015) Potential use of geothermal heat in lithium-ion battery production. *World Geothermal Congress 2015*. Melbourne, Australia, pp 1–6
- Sakti A, Michalek JJ, Fuchs ERH, Whitacre JF (2015) A techno-economic analysis and optimization of Li-ion batteries for light-duty passenger vehicle electrification. *J Power Sources* 273:966–980. <https://doi.org/10.1016/j.jpowsour.2014.09.078>
- Scrosati B, Garche J (2010) Lithium batteries: Status, prospects and future. *J Power Sources* 195:2419–2430. <https://doi.org/10.1016/j.jpowsour.2009.11.048>
- Shen PK, Wang C-Y, Jiang SP et al (2015) *Electrochemical energy: advanced materials and technologies*. CRC Press, Boca Raton
- Tarascon J-M, Armand M (2001) Issues and challenges facing rechargeable lithium batteries. *Nature* 414:359–367. <https://doi.org/10.1038/35104644>
- Thackeray MM, Wolverton C, Isaacs ED (2012) Electrical energy storage for transportation—approaching the limits of, and going beyond, lithium-ion batteries. *Energy Environ Sci* 5:7854. <https://doi.org/10.1039/c2ee21892e>
- Whittingham MS (2008) Materials challenges facing electrical energy storage. *MRS Bull* 33:411–419. <https://doi.org/10.1557/mrs2008.82>
- Whittingham MS (2004) Lithium batteries and cathode materials. *Chem Rev* 104:4271–4301. <https://doi.org/10.1021/cr020731c>
- Xu B, Qian D, Wang Z, Meng YS (2012) Recent progress in cathode materials research for advanced lithium ion batteries. *Mater Sci Eng R Reports* 73:51–65. <https://doi.org/10.1016/j.mser.2012.05.003>
- Xu J, Dou S, Liu H, Dai L (2013) Cathode materials for next generation lithium ion batteries. *Nano Energy* 2:439–442. <https://doi.org/10.1016/j.nanoen.2013.05.013>

# Design and Structural Analysis of a Prosthesis for an Arthroplasty. Definition of the Osseointegration Grade During the Rehabilitation Process



F. Cavas-Martínez, D. Parras-Burgos, J. Nieto, F. J. F. Cañavate and D. G. Fernández-Pacheco

**Abstract** One of the main issues that shoulder arthroplasty presents during the execution of rehabilitation exercises is its mechanical stability. In the particular case of the prosthesis-humerus set, a structural analysis of the set is necessary with the aim of defining the osseointegration grade in the different regions, considering the influence of the stress level which will be applied during the rehabilitation process, thus preventing bio-integration problems. The present communication aims to obtain the geometric model of a set by using CAD technologies and its posterior structural analysis by means of finite element analysis under the action of various load conditions. The prosthesis-humerus generated model becomes very useful for the orthopedic physician because it allows defining and programming the different stresses to apply during the rehabilitation process according to the osseointegration grade existing in the set region, thus preventing and minimizing the possible complications that could be derived by such process.

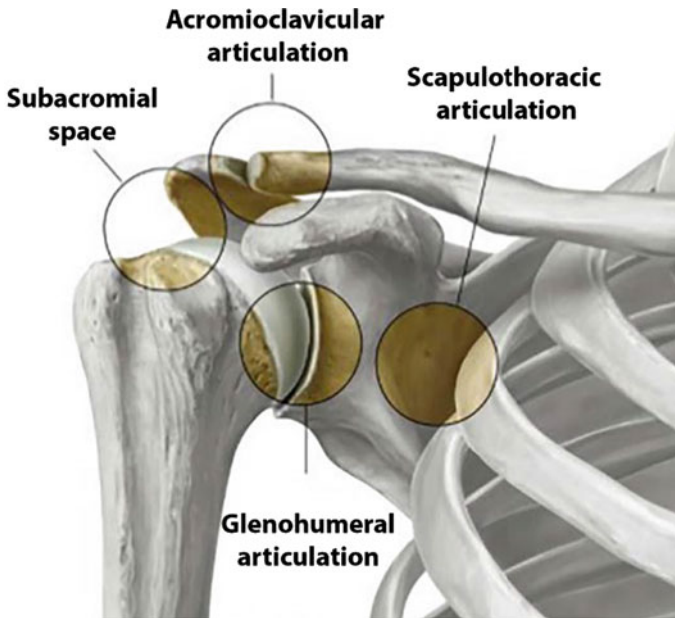
**Keywords** Computational geometry · 3D modelling · Finite elements Prosthesis · Biomedicine

## 1 Introduction

One of the methods used to treat shoulder joint ailments is articular substitution using shoulder prosthesis. In spite of the invasive nature of this method, it has been demonstrated that it is a sound approach to treat glenohumeral joint problems (Fig. 1). With the help of numerical methods used to solve mathematical models, structural analyses can be performed to determine stresses in three-dimensional models of the interface between the prosthesis and the bone where it is inserted,

---

F. Cavas-Martínez (✉) · D. Parras-Burgos · J. Nieto · F. J. F. Cañavate  
D. G. Fernández-Pacheco  
Dpto. de Expresión Gráfica, Universidad Politécnica de Cartagena,  
C/Doctor Fleming s/n, 30202 Cartagena, Murcia, Spain  
e-mail: francisco.cavas@upct.es



**Fig. 1** Shoulder joints

allowing to identify, knowing the bulk density of the bone tissue, the zones where osseointegration is enhanced. Osseointegration zones identification allows determining prior to surgery, the bone behaviour once the prosthesis is inserted, thus giving the possibility of assessing different models for joint substitution.

The first reported shoulder prosthesis date back to the 14<sup>th</sup> century, when a prosthetic replacement was performed in France to treat a tuberculous arthritis. But its actual clinical use began in the 20th century when orthopedic surgeon Charles S. Neer designed an implant to treat humeral head fractures (Foruria et al. 2008). Since the second half of the 20th century, new designs were made to improve its functionality. Despite the time elapsed, the use of this type of arthroplasty is not as extended as hip replacement (Barlow et al. 2016; Cavas-Martínez et al. 2015; Oosting et al. 2016; Wu et al. 2016) or knee replacement (Ferrara et al. 2016; Haaker 2016; Tibesku 2016), although there is evidence that it is as safe and lasting as hip and knee prostheses.

In the recent decades, important steps have been taken in partial shoulder arthroplasties components design (Hopkins et al. 2006; Yang et al. 2013). By using the newest digital technologies, a better knowledge of anatomy has been acquired and the main morphological characteristics have been highlighted, as well as the variabilities between individuals of the substituted structures (Serrano Reche et al. 2010), allowing the manufacture of more anatomical implants (Cisneros et al. 2016). The possibility of selecting head components orientation and size, the fastening methods for the stems, designs that do not use stems and prosthesis designed under different philosophies which does not imitate normal anatomy, allow

shoulder surgeons to choose between a wide variety of options for the different cases of partial arthroplasty (Rodríguez-Piñero Durán et al. 2007).

In order to perform a structural analysis of the prosthesis-humerus complex, it is necessary to obtain a prosthesis geometry (Budge et al. 2013; Liem et al. 2007). The properties of the prosthesis material and the type of bone tissue to be analysed must also be known. Once all these data is acquired, the loads applied to the model will be graphically simulated to obtain the model's mechanical behaviour.

## 2 Methodology

To obtain the prosthesis three-dimensional design, a sketch of the prosthesis was made from the measurements taken, with a high level of precision for the geometrical design. Once the model design is obtained, a structural analysis of the prosthesis-humerus complex was performed to detect possible osseointegration levels when different load levels are applied to the prosthesis.

### 2.1 *Prosthesis-Humerus Three-Dimensional Modelling*

To obtain the prosthesis-humerus model, the 3D mechanical design software Autodesk Inventor was used, since this software has the necessary tools for modelling three-dimensional complex structures. With the purpose of obtaining a model with a high level of similarity, measurements were made to an actual shoulder prosthesis using a Universal calliper with a minimum division of 0.1 mm, an Exterior Interior calliper with a minimum division of 0.05 mm and a protractor as measurement tools. Once the measurements were taken, a prosthesis sketch was made (Fig. 2) and the three-dimensional model was created, obtaining a high similarity model with respect to the original one.

To perform the structural analysis of the prosthesis-humerus model using the Finite Element method, the ALGOR software was used. This software offers the necessary applications for structural analysis under static loads as well as under variable load conditions. Another important factor to take into account is its capacity to easily import models obtained by using advanced drawing and design software like the Autodesk Inventor.

Once the model generated using Autodesk was imported, the finite element mesh was made to the whole complex using 10-node three-dimensional tetrahedral elements and this mesh was refined (Fig. 3).

The entire Grade 5 Titanium's and trabecular bone's mechanical properties were defined (Table 1) as they are components of the prosthesis-humerus complex. The analysed prosthesis is totally made of Grade 5 Titanium, known as Ti6Al4V, with a 6% Aluminum and 4% Vanadium. This is the most used titanium alloy, especially in the aeronautical sector, biomedicine or stomatology fields. It has a tension

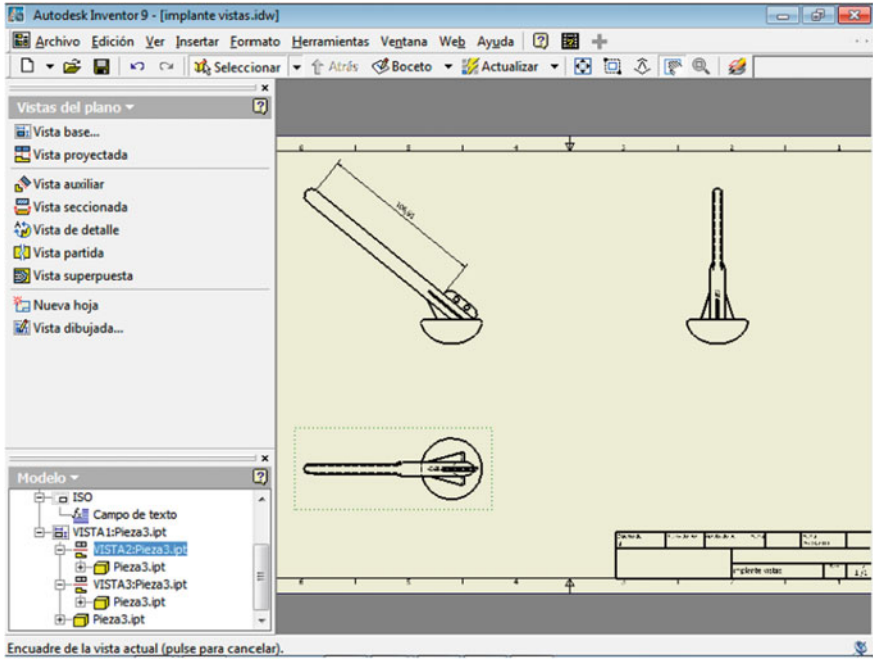


Fig. 2 Design of the prosthesis sketch

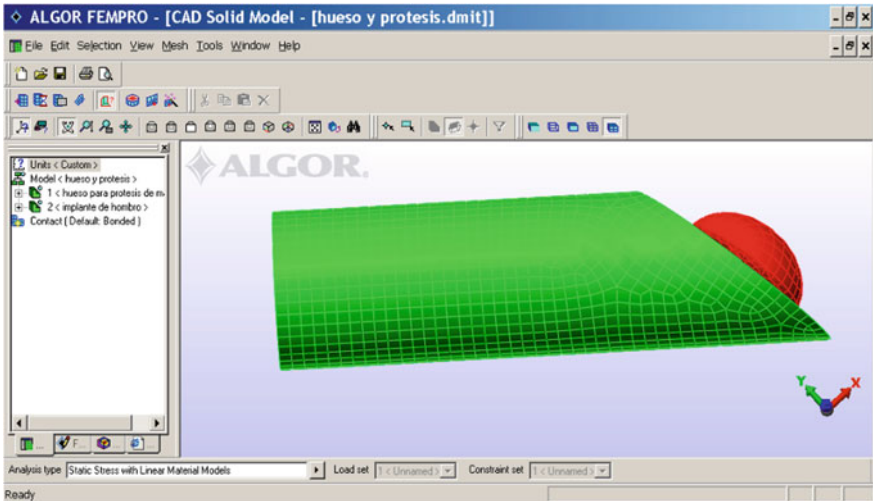


Fig. 3 Model with refined mesh

**Table 1** Prosthesis-humerus mechanical properties

Properties	Prosthesis (Ti6Al4V)	Humerus
Young modulus (MPa)	112000	18000
Poisson coefficient	0.3	0.3

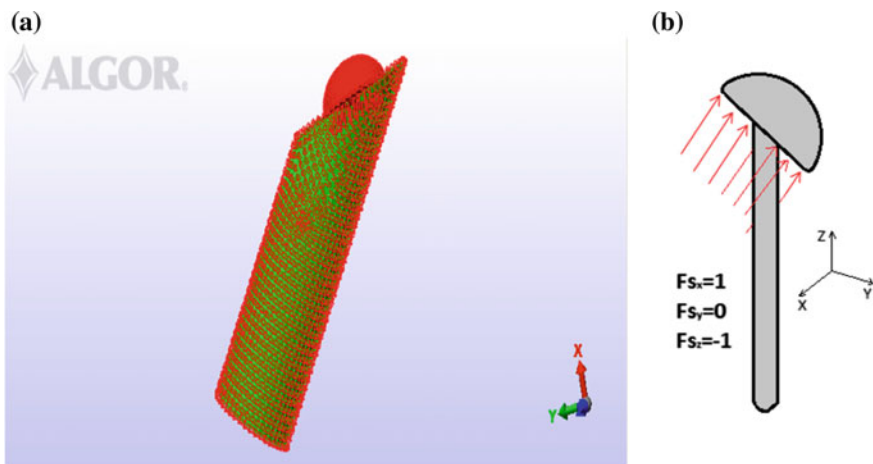
strength of 896 MPa, a longitudinal modulus of elasticity of 112000 MPa, 10% ductility, a hardness of 33 HRB, a very good weldability and an electrical resistivity of 1.67 ( $\mu\Omega\text{m}$ ). It is used in applications where high mechanical strength is required.

With regard to the bone of the prosthesis-humerus complex, the analysis was made based on a bone with a density range from 0.8 to 1.1  $\text{g/cm}^3$ , with a longitudinal elasticity modulus of 18000 MPa and a Poisson coefficient of 0.3.

**2.1.1 Boundary Conditions**

For the case of the prosthesis-humerus complex, flexible restrictions were applied on the two surfaces that simulated the bone. These restrictions were applied on the -X, -Y and -Z axes with a stiffness value of 10 GPa. A rigid restriction was applied for the bone base eliminating the 6 Degrees of Freedom (Fig. 4a). The forces applied to the model were set on the X and -Z axes (Fig. 4b).

In the anterior part of the prosthesis' humeral head, load values were applied corresponding to the patient's static position making abduction movements with his arm free of weight at 0, 30, 60 y 90°. The forces direction was defined taking into account the influence of the Supraspinatus, Infraspinatus and Subscapularis muscles belonging to the Rotator Cuff and all the forces have the same direction. The applied load values were taken from Baumgartner et al. (2009), taking into account



**Fig. 4** a Model with applied restrictions, b free body diagram with forces direction

**Table 2** Forces acting on the prosthesis-humerus complex (Suárez et al. 2009)

Rotator cuff conditions	Reaction force on the glenohumeral joint (N)			
	Abduction movement angle			
	0°	30°	60°	90°
S100	93	233	359	427
S50	92	234	364	441
S00	92	234	363	441
SINF00	114	249	344	427

four different Rotator Cuff conditions: exerting 100% of its maximum load capacity (S100), with the supraspinatus muscle exerting 50% of the maximum load capacity (S50), with the supraspinatus muscle exerting 0% of the maximum load capacity (S00) and with the supraspinatus and infraspinatus muscles both exerting 0% of their load capacity (SINF00) (Table 2) (Suárez et al. 2009).

### 3 Results

Hereafter, the evidences and interpretation of the results obtained from the structural analysis of the prosthesis-humerus complex, using the software ALGOR are shown. Simulations were performed applying four different load levels to the complex, so that the load exerted by the rotator cuff muscles over the glenohumeral joint could be represented. This was made for different angles of the abduction movement.

#### 3.1 Equivalent Stresses Analysis

For the equivalent stresses analysis adopting the Von Mises criterion, all combinations of loads acting over a body are taken into account and points with the higher permanent deformation tendencies in the analysed material are identified. The Von Mises criterion provides the possibility to recognize a good design because it allows determining if the stresses produced in the component are permissible.

For the stress calculation, the loads on the glenohumeral joints were taken into account with four different rotator cuff conditions and four different angles in the abduction movement. The rotator cuff conditions are the following:

- Exerting 100% of its maximum load capacity.
- With the supraspinatus muscle exerting 50% of the maximum load capacity.
- With the supraspinatus muscle exerting 0% of the maximum load capacity.
- With the supraspinatus and infraspinatus muscles both exerting 0% of their load capacity.

After considering all these conditions, the calculation of the stresses was focused on the above mentioned second rotator cuff condition, with the supraspinatus muscle exerting 50% of the maximum load capacity. The stresses were assessed for angles of 0, 30, 60 and 90°, during the abduction movement.

## 3.2 Stresses Calculation

Loads applied for the stress calculation are closely related with the angles taken into account for the abduction movement (see Table 3).

In the figures shown hereafter, the stress levels generated by the forces applied are presented.

### 3.2.1 Case 1: Abduction Angle 0°

In Fig. 5a, it can be observed that the highest stress values on the prosthesis are accumulated in the stem and in the anterior zone of the prosthesis humeral head and they reach a maximum value of 11.13 MPa. This value is far below the elastic limit of the material (see Table 1), so there is no risk of fracture. Figure 5b shows the maximum stresses in the humerus, being of interest those found on the zone where the prosthesis is inserted.

### 3.2.2 Case 2: Abduction Angle 30°

The highest stresses on the prosthesis produced by a force of 234 N are observed along the stem with some appreciable values on the humeral head, mainly in its anterior part (Fig. 6a). These stresses reach a maximum value of 28.33 MPa, far below the elastic limit of the material. Figure 6b shows the maximum stresses on the humerus when a force of 234 N is exerted. The highest stresses are found in the support area of the prosthesis over the bone.

**Table 3** Von Mises stresses generated by different loads with the supraspinatus muscle exerting 50% of the maximum load capacity

Angles	Forces (N)	Stresses (MPa)	
		Prosthesis	Humerus
0°	92	11.13	4.67
30°	234	28.33	11.87
60°	364	44.07	18.47
90°	441	53.39	22.38



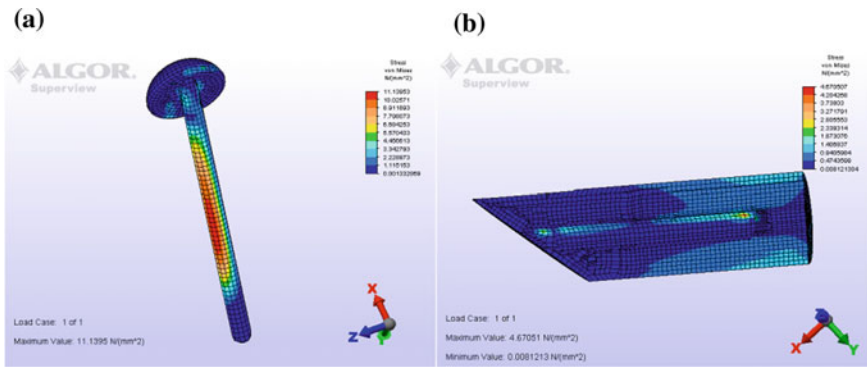


Fig. 5 Von Mises stresses for 92 N in: **a** the prosthesis, **b** the humerus

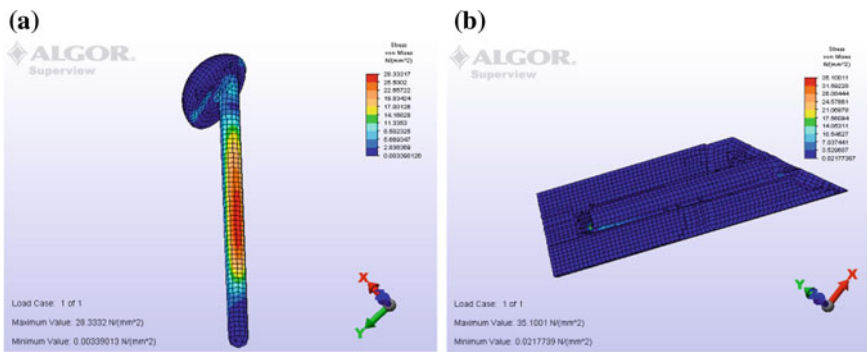


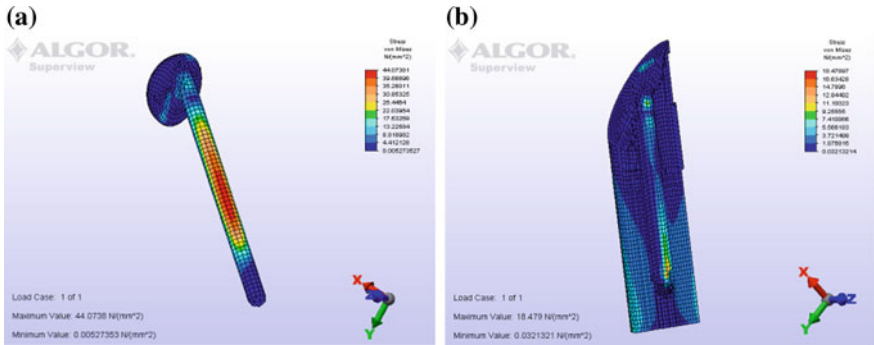
Fig. 6 Von Mises stresses for 234 N in: **a** the prosthesis, **b** the humerus

### 3.2.3 Case 3: Abduction Angle 60°

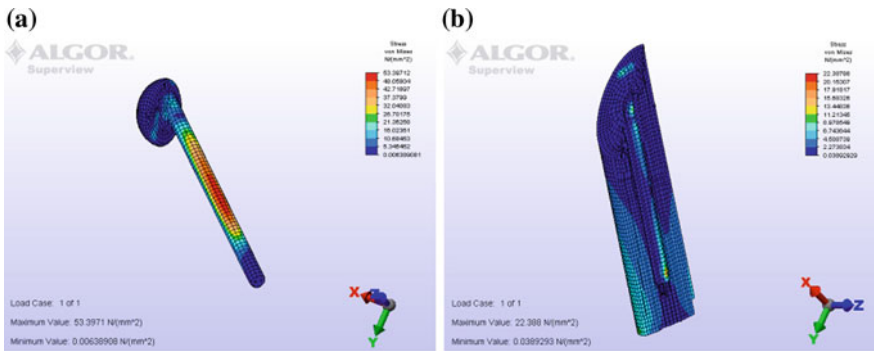
On Fig. 7a, it can be observed that the maximum stress concentration is distributed all over the prosthesis stem and on the anterior part of the humeral head. The stress maximum value will be 44.07 MPa, far below the elastic limit of the prosthesis material. When a force of 364 N is applied, the maximum stresses to be taken into account will be found all over the zone where the prosthesis is inserted, with a maximum value of 18.47 MPa.

### 3.2.4 Case 4: Abduction Angle 90°

In the case of the 441 N force applied to the prosthesis, the maximum stresses will still be found along the stem and in the anterior part of the humeral head (Fig. 8a), with a value of 53.39 MPa, which still is much lower than the elastic limit of the prosthesis material. The maximum stresses on the humerus when a 441 N force is



**Fig. 7** Von Mises stresses for 364 N in: **a** the prosthesis, **b** the humerus



**Fig. 8** Von Mises stresses for 441 N in: **a** the prosthesis, **b** the humerus

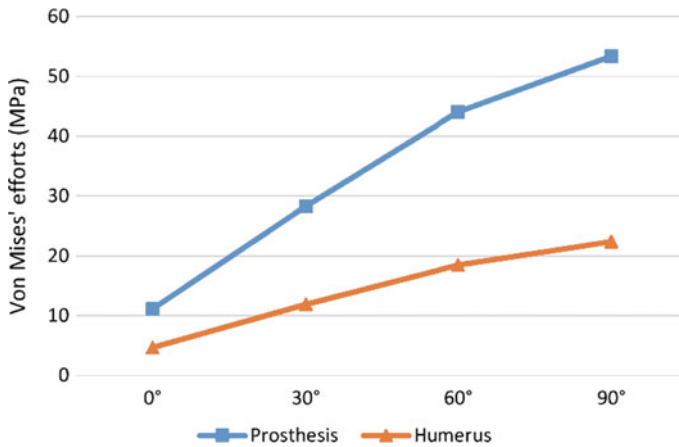
applied, will still be on the zone where the prosthesis is inserted (Fig. 8b), and its value will be 22.38 MPa.

### 3.3 Results Discussion

As it can be observed in Fig. 9, the Von Mises stresses were increasing as a higher load was applied for each case.

With regard to the stresses produced on the shoulder prosthesis for each case, none of the stresses values came near to the elastic limit of the prosthesis material, so the possibility of fracture occurrence never existed, which assured the prosthesis utilization without risk of damage for the patient in any of the cases.

When analysing the humerus stresses, it is noticeable that the highest values are produced when the arm is elevated 90° in the abduction movement. These values



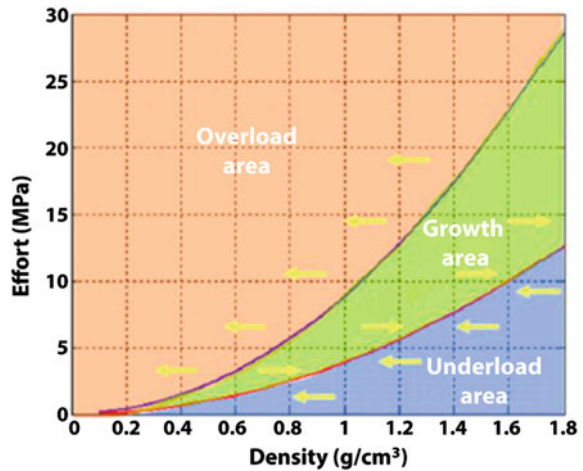
**Fig. 9** Obtained stresses for each case

are found in the zone near the prosthesis humeral head where it is inserted in the bone.

### 3.4 Osseointegration Analysis

The applied mechanical load and the apparent density characterize the mechanical properties of the bone. The existing relationship between the equivalent stresses and the apparent density of the bone tissue directly influence the bone remodelling when a fracture occurs or when a joint is substituted by a prosthesis (Fig. 10).

**Fig. 10** Stress versus density



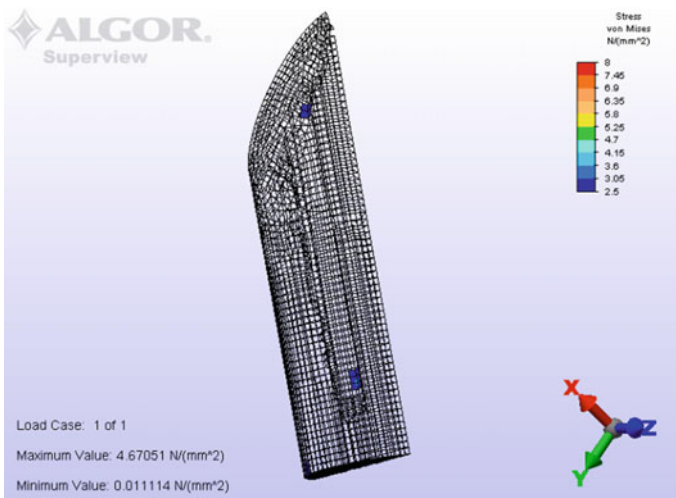
Various studies establish an apparent humerus bone density between 0.8 and 1.1  $\text{g}/\text{cm}^3$  (Pokines and Symes 2013). By analysing Fig. 10, it can be observed that equivalent stress values that favour humerus osseointegration are found between 2.5 and 8 MPa. Hereafter, the osseointegration degree is analysed for each one of the case studies:

### 3.4.1 Case 1: Angle $0^\circ$ and Load 92 N

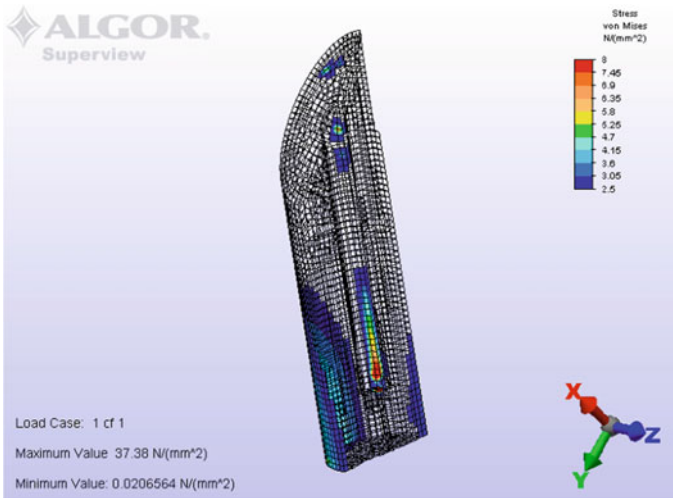
In Fig. 11, it can be noted that in the support zone of the prosthesis where it is inserted on the bone, the equivalent stresses vary from 2.5 to 8 MPa. The same happens in the zone near the prosthesis' humeral head, so it can be stated that these areas favour osseointegration.

### 3.4.2 Case 2: Angle $30^\circ$ and Load 234 N

In Fig. 12, it is noticeable that the areas where osseointegration is favoured are the zone near the prosthesis humeral head where it is inserted and the various zones where the prosthesis stem is going to be inserted.



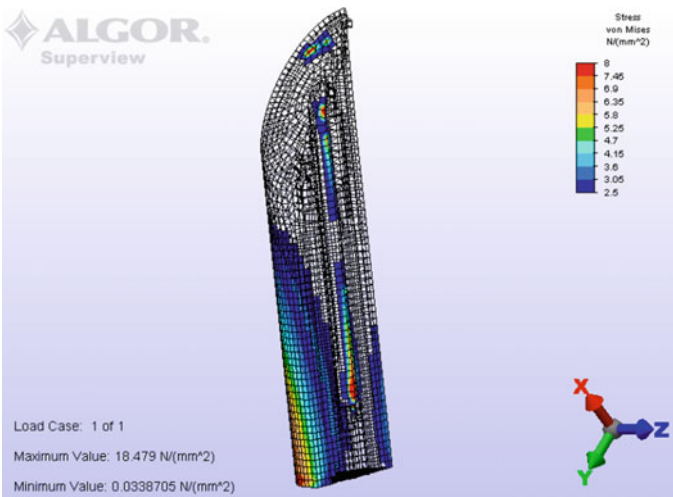
**Fig. 11** Stress range from 2.5 to 8 MPa in the humerus with a load of 92 N



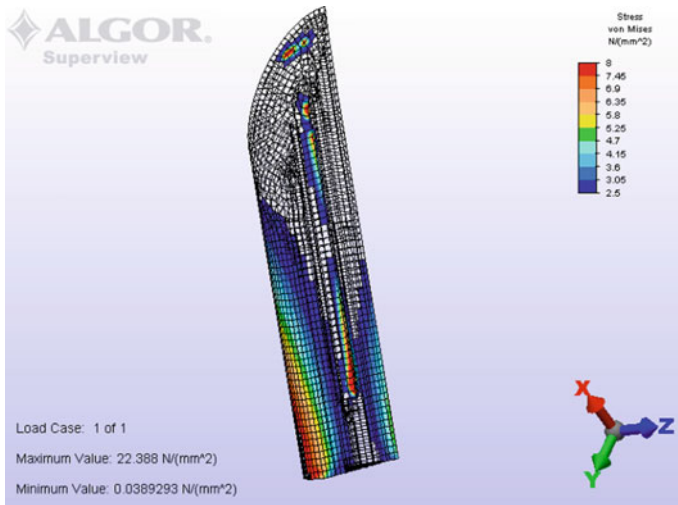
**Fig. 12** Stress range from 2.5 to 8 MPa in the humerus with a load of 234 N

### 3.4.3 Case 3: Angle $60^\circ$ and Load 364 N

Figure 13 shows that in the zone near the prosthesis humeral head and the zone where the prosthesis stem is inserted, including the prosthesis support zone, the equivalent stress values favour osseointegration.



**Fig. 13** Stress range from 2.5 to 8 MPa in the humerus with a load of 364 N



**Fig. 14** Stress range from 2.5 to 8 MPa in the humerus with a load of 441 N

#### 3.4.4 Case 4: Angle 90° and Load 441 N

Figure 14 shows that in the entire zone where the prosthesis is inserted to the bone, osseointegration is favoured.

When analysing the studied cases, it can be concluded that as the load values are increased, the prosthesis will transmit a higher quantity of stresses to the humerus, which will increase osseointegration probabilities in the bone.

## 4 Conclusions

The study performed in this work has a great social impact because its results will allow verifying shoulder arthroplasty efficiency as a method to treat shoulder joint injuries.

The results of this work have been satisfying, because it was possible to determine which humerus zones favour bone osseointegration. It allowed to verify that shoulder prosthesis have the same reliability level than other prosthesis. Using the Finite Element Model other parameters can also be assessed, for example strains in the prosthesis material. This will favour the study of the prosthesis material behaviour, optimising the design methodology in future studies.

This work results will allow for a reduction on the number of postoperative problems and complications, because it is possible to analyse the bone behaviour once the prosthesis is inserted, prior to surgery.

## References

- Barlow BT, Boles JW, Lee YY, Ortiz PA, Westrich GH (2016) Short-term outcomes and complications after rejuvenate modular total hip arthroplasty revision. *J Arthroplast* 31(4):857–862. <https://doi.org/10.1016/j.arth.2015.10.041>
- Baumgartner D, Lorenzetti SR, Mathys R, Gasser B, Stussi E (2009) Refixation stability in shoulder hemiarthroplasty in case of four-part proximal humeral fracture. *Med Biol Eng Compu* 47(5):515–522. <https://doi.org/10.1007/s11517-009-0483-7>
- Budge MD, Kurdziel MD, Baker KC, Wiater JM (2013) A biomechanical analysis of initial fixation options for porous-tantalum-backed glenoid components. *J Shoulder Elbow Surg* 22(5):709–715. <https://doi.org/10.1016/j.jse.2012.07.001>
- Cavas-Martínez F, Cañavate FJF, Nieto J, Fernández-Pacheco DG (2015) Diseño geométrico y simulación de funcionalidad de una prótesis de cadera en el sistema musculoesquelético del cuerpo humano. In: 19th International Congress on project management and engineering (AEIPRO 2015), Granada, España, 2015. Asociación Española de Dirección e Ingeniería de Proyectos, pp 1061–1070
- Cisneros LGN, Atoun E, Abraham R, Tsvieli O, Bruguera J, Levy O (2016) Revision shoulder arthroplasty: does the stem really matter? *J Shoulder Elbow Surg* 25(5):747–755. <https://doi.org/10.1016/j.jse.2015.10.007>
- Ferrara F, Cipriani A, Rapisarda S, Iacobucci M, Magarelli N, Leone A, Bonomo L (2016) Assessment of implant position after total knee arthroplasty by dual-energy computed tomography. *Acta radiologica (Stockholm, Sweden: 1987)* 57(5):612–619. <https://doi.org/10.1177/0284185115595656>
- Foruria AM, Antuña S, Rodríguez-Merchán EC (2008) Prótesis parcial de hombro: revisión de conceptos básicos. *Revista Española de Cirugía Ortopédica y Traumatología* 52(06):392–402
- Haaker R (2016) Evolution of total knee arthroplasty. From robotics and navigation to patient-specific instruments. *Orthopade* 45(4):280±. <https://doi.org/10.1007/s00132-016-3238-9>
- Hopkins AR, Hansen UN, Amis AA, Taylor M, Gronau N, Anglin C (2006) Finite element modelling of glenohumeral kinematics following total shoulder arthroplasty. *J Biomech* 39(13):2476–2483. <https://doi.org/10.1016/j.jbiomech.2005.07.031>
- Liem D, Marquardt B, Witt KA, Steinbeck J (2007) Shoulder arthroplasty - biomechanics and design. *Orthopade* 36(11):1027±. <https://doi.org/10.1007/s00132-007-1156-6>
- Oosting E, Hoogbeem TJ, Appelman-de Vries SA, Swets A, Dronkers JJ, van Meeteren NLU (2016) Preoperative prediction of inpatient recovery of function after total hip arthroplasty using performance-based tests: a prospective cohort study. *Disabil Rehabil* 38(13):1243–1249. <https://doi.org/10.3109/09638288.2015.1076074>
- Pokines J, Symes SA (2013) *Manual of forensic taphonomy*. CRC Press
- Rodríguez-Piñero Durán M, Rodríguez-Burgos C, Cárdenas-Clemente J, Echevarría-Ruiz de Vargas C (2007) Artroplastia de hombro. *Rehabilitación* 41(06):248–257
- Serrano Reche MA, Chumillas Luján MS, Navarro Collado MJ, Moreno Barragán DA, Morales Suárez-Varela M (2010) Valoración funcional y calidad de vida en pacientes con prótesis de hombro. *Rehabilitación* 44(3):250–255. <https://doi.org/10.1016/j.rh.2009.10.005>
- Suárez DR, Valstar ER, van der Linden JC, van Keulen F, Rozing PM (2009) Effect of rotator cuff dysfunction on the initial mechanical stability of cementless glenoid components. *Med Biol Eng Compu* 47(5):507–514. <https://doi.org/10.1007/s11517-009-0475-7>
- Tibesku CO (2016) Total knee arthroplasty with the use of patient specific instruments. The VISIONAIRE system. *Orthopade* 45(4):286–293. <https://doi.org/10.1007/s00132-016-3239-8>

- Wu X, He BX, Tan YJ (2016) Progress on classification and application of artificial hip joint materials. *Zhongguo gu shang = China J Orthop Traumatol* 29
- Yang CC, Lu CL, Wu CH, Wu JJ, Huang TL, Chen R, Yeh MK (2013) Stress analysis of glenoid component in design of reverse shoulder prosthesis using finite element method. *J Shoulder Elbow Surg/Am Shoulder Elbow Surg [et al]* 22(7):932–939. <https://doi.org/10.1016/j.jse.2012.09.001>



# MOTIVA-PRO: Innovation Based on Users' Motivations



D. Justel, A. Retegi, I. Iriarte, G. Lasa and I. González

**Abstract** For many years, design activity has adopted the problem-solving perspective. In this approach, solutions are based on users' problem identification. However, to what extent do users truly seek the satisfaction of their needs? The key to successful innovation is market acceptance, and users' motivations play a fundamental role in ensuring this. This paper presents the MOTIVA-PRO innovation guide. MOTIVA-PRO enables the concretisation of innovation opportunities from the perspective of users' motivations. Considering users' motivations (self-assurance, self-esteem, relatedness, etc.) instead of their problems as the starting point for design innovation processes provides deeper insights into the real needs of stakeholders (clients, suppliers, etc.). This enables the design of products and services (systems) that are more in line with stakeholders' expectations.

**Keywords** Methodology · Motivation · Needs · Product service innovation  
Product service design

---

D. Justel · A. Retegi · I. Iriarte (✉) · G. Lasa · I. González  
Faculty of Engineering, Design Innovation Center (DBZ), University of Mondragon,  
Loramendi 4, 20500 Arrasate, Mondragón, Spain  
e-mail: iiriarte@mondragon.edu

D. Justel  
e-mail: djustel@mondragon.edu

A. Retegi  
e-mail: aretegi@mondragon.edu

G. Lasa  
e-mail: glasa@mondragon.edu

I. González  
e-mail: igonzalez@mondragon.edu

## 1 Introduction

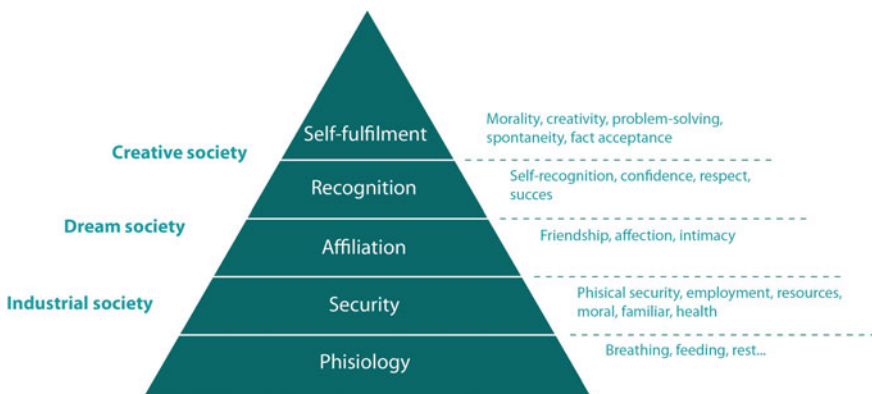
In the current socio-economic context, factors such as market saturation, technological evolution and new interaction codes have led to the evolution of user-client and business-user relationships. Ardèvol (2006) describes three fundamental reasons for this transition:

1. The acceleration of social changes as a result of the evolution towards an information society characterised by the rapid spread of ideas,
2. The economic transition towards an experience economy, where immaterial consumption grows more rapidly as compared to material consumption and
3. The increase of emotional elements, led by technological development where almost everything is manufactured.

Mogensen's (2006) model describes this transition in terms of a pyramid called Society Logics, which is based on Maslow's (1943) hierarchical pyramid and discusses three social paradigms that can be currently identified in western societies. The three social paradigms are the industrial society, the dream society and the creative society (Fig. 1). On the one hand, Maslow's pyramid identifies individuals' hierarchy of needs. On the other hand, Mogensen's (2006) new interpretation provides insights into the social changes currently taking place.

Along the same lines, Anderson (2007) provided a similar interpretation of this model, proposing another hierarchy based on Maslow (1943). This approach emerges from interaction design and defines a new pyramid where experiences and meaning prevail over the functional attributes of things. Thus, in the order of priorities, from greater to lesser importance, these attributes include significance, pleasure, convenience, utility, usability, reliability and, lastly, functionality.

Companies have started realising that in order to create stronger emotional ties with users, there is a need for a new formula that places greater emphasis on users'



**Fig. 1** Maslow and Mogesen's pyramid (Retegi et al. 2012)

desires. Therefore, user experience is increasingly acquiring strength as a way to motivate the user. Examples of such companies include BMW (Eckoldt et al. 2012), Coca-Cola (Chong 2012), Philips (Phillipswakeupthetown 2010), Nespresso (Futurebrand 2012), Kone (2011) and Milka (BuzzmanTV 2013).

The importance attributed to personal significance is a reflection of the evolution described earlier. From the new socio-economic context, meaning and experience have become more important. Human beings seek new stimuli. New products or services have become the medium through which this significance is interpreted in a subjective and individualistic manner (Diller et al. 2008).

Models, like the one proposed by Anderson (2007), serve as a catalyst for new approaches within design activity, in which humans form the starting point for design and remain the heart of new product or service development. With the inclusion of users in design development, design approaches aim to strengthen the consumer experience and emotional connection. Some significant examples of this evolution include the 'human-centred design' (HCD) approach (IDEO 2011), methodologies based on co-creation (Sanders and Dandavate 1999), 'design for all' philosophies (Aragall and Montaña 2012) and user-driven innovation processes (DBZ 2014). These approaches that are being developed in the context of design activity originate from the premise that people and their needs form the *raison d'être* of innovation. However, to what extent is the user really seeking satisfaction of his or her needs? The key to successful innovation is market acceptance, and it is in this acceptance that users' motivations play a fundamental role.

## 2 Research Objective

The main objective of this communication is to develop a structured guide (MOTIVA-PRO), which allows companies to learn how to concretise innovation opportunities from the perspective of users' motivations.

First, this communication describes the theoretical basis of the guide. Subsequently, the guide is presented with its phases and sub-phases. Finally, the conclusions are provided with respect to the guide's creation process as well as the steps to be taken subsequently.

## 3 Methodological and Theoretical Basis

For many years, design activity focused on problem solving. The principle behind this approach was to identify users' problems in order to solve them. In product or service design, the same element is typically understood from two perspectives: the designer's view and the user's view. According to Hassenzahl (2005), a user perceives different characteristics of a product (that may be similar or not to the ones proposed by the designer). These characteristics are the sum of the hedonic

and pragmatic attributes related to the emotional perception of the use. The interpretation of these characteristics can be expressed in three ways: product judgment (good or bad), the emotional consequence (pleasure, satisfaction, etc.), and the behavioural consequence (to buy or not to buy). However, any interpretation is usually influenced by the context.

To what extent does the user truly require this need to be satisfied? Real innovation arrives when there is market acceptance. Motivation plays an essential role in this context. Thus, to begin the innovation process from motivation (self-assurance, self-esteem, relatedness, etc.), it is useful to delve deeper into the stakeholders' (clients, suppliers, etc.) real needs and the reasons for these needs.

This ensures that products and services (artefacts) are designed in a way that aligns with users' expectations. Accordingly, Hassenzahl (2010) (and other authors following his work, such as Lenz et al. (2012) and Retegi (2016), among others) builds upon the theory of Sheldon et al. (2001) to identify the motivations for the experience. Their results showed that positive experiences are related to ten needs: self-esteem, autonomy, competence, relatedness, pleasure-stimulation, physical well-being, luxury, self-fulfilment, popularity and security. Therefore, it is relevant for designers to consider these needs in the design process.

Moreover, the stakeholder's analysis is a key aspect in identifying people's needs, and any of the above-mentioned methodologies (IDEO, DBZ, etc.) can add value when working with different agents involved in the project. However, Wasson (2000) defines 'AEIOU'—Actions, Environments, Interactions, Objects and Users—as a heuristic approach to interpret observations through ethnography in practice. This work creates a scenario that enables the analysis of the design process with an aspect-integrating view that prevents a disconnect between the various requirements. Thus, following the AEIOU parameter, a global or integrating vision of the analyses is achieved.

The MOTIVA-PRO guide is therefore based on (Fig. 2) Sheldon et al. (2001), Hassenzahl (2010), Wasson (2000), Retegi (2016) and the people-centred design methodology of Design Innovation Center (DBZ), including its tools and techniques (DBZ 2014). Retegi (2016) identifies the five pillars around which the innovation is developed based on users' motivations:

- **Person:** This refers to the person who carries out the action. This person is the recipient and the target of the motivation. It is therefore necessary to understand the person and consider the diversity of their capabilities.
- **Motivation:** This describes the reason behind any action. This element forms the starting point for the creation of an experience.
- **Context:** The context implies that it is useful to define the remaining elements, the action framework and the situation to be addressed.
- **Action:** The sequence of events that occurs between the person and his or her environment forms the action. These sequences generate a memory in the person's mind.
- **System (product and/or service):** This refers to the means that enables the action. It is the element that brings about the result of the entire process.

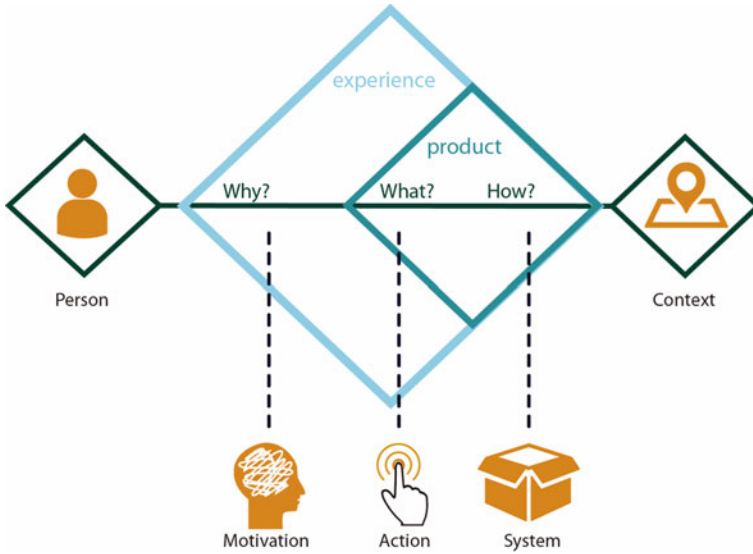


Fig. 2 The five pivoting elements of innovation from the motivations (adapted from Reteigi (2016))

### 4 MOTIVA-PRO Methodology

The MOTIVA-PRO guide is based on some reflections made during the development of Reteigi's (2016) the doctoral thesis. The guide aims to consider stakeholders' motivations in the innovation process of DBZ (Fig. 3).

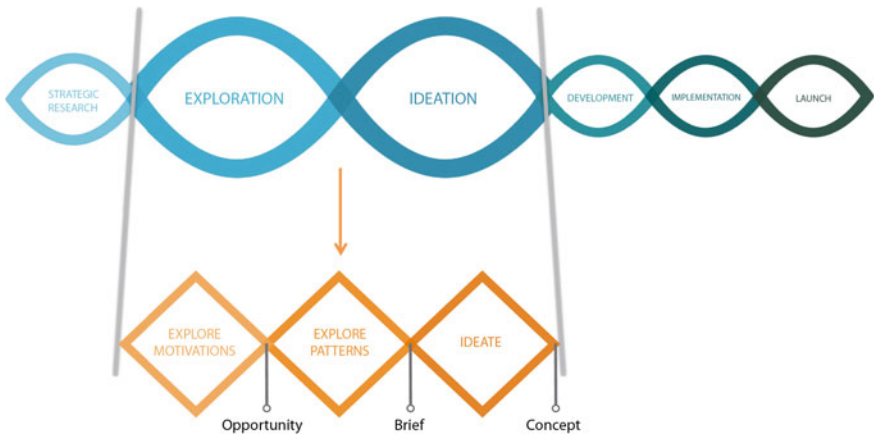


Fig. 3 DBZ methodology and MOTIVA-PRO guide

The MOTIVA-PRO guide comprises three phases: exploring users' motivations, exploring the patterns and ideation. In the first phase, opportunities are identified based on people's motivations. In the second phase, behavioural patterns are identified for each motivation. Next; these patterns help to define a design brief. Finally, the third phase converts the brief into product or service concepts that may be motivating to users.

In the subsequent sections, each phase and their sub-phases are described, as well as the support tools proposed.

#### 4.1 To Explore Users' Motivations

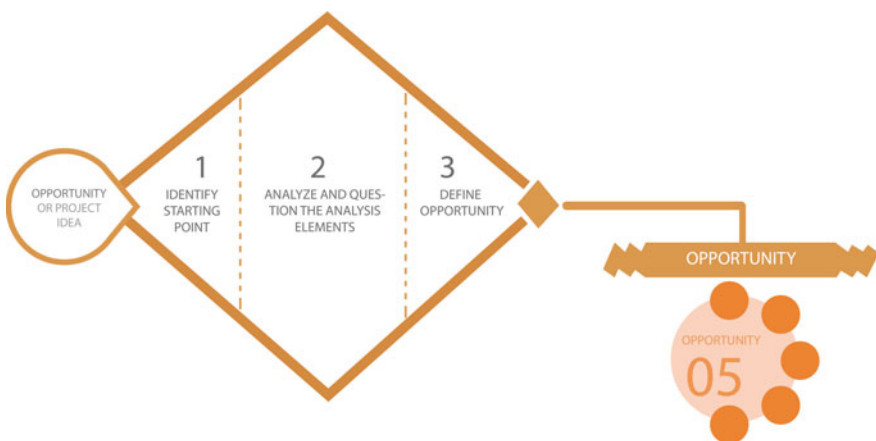
Based on the project ideas, opportunities are identified and classified on the following basis: person, action, motivation, context and system. This phase comprises three sub-phases (Fig. 4): (1) Identifying the starting point, (2) Analysing and question the elements of the analysis and (3) Defining the opportunity.

##### (1) Identifying the starting point

Firstly, the project objective is gathered. Secondly, the project's stakeholders are identified using the 'actor map' tool (Morelli and Tollestrup 2007). Finally, information about the project that is already known is gathered through Retegi's (2016) 'experience canvas'. This canvas is based on the five elements, namely, person, action, motivation, context and system.

##### (2) Analysing and questioning the elements of the analysis

This sub-phase is divided into three stages: (i) analysing the five elements, (ii) investigating the users and (iii) gathering insights and opportunities.



**Fig. 4** To explore users' motivations

(i) In analysing the five elements, namely, person, action, motivation, context and system (product and/or services), the information is visualized using Buzan's (1996) 'mindmap' tool. Based on the information gathered through the 'experience canvas', the information that is known, not known and needed is discussed for each of the elements.

- Person: It is necessary to define the potential users' profiles by employing the 'persona' tool provided by Jenkinson (1994) and statistical data pertaining to population and diversity (capacities, genders, culture, age, etc.). Additionally, life styles are specified for the profiles.
- Action: The key actions of the problem are identified in the temporal line using the 'customer journey map' advanced by Curedale (2013). Additionally, causes related to the key actions and the problem are analysed.
- Motivation: This involves identifying the motivation behind the problem. For this purpose, the team uses Retegi's (2016) 'needs cards' based on Hassenzahl et al. (unpublished) and empathy. Finally, a question arises as to whether we understand the user's true motivation in purchasing the product or service.
- Context: This refers to the context in which the system will be implemented. Retegi's (2016) 'scenario' tool can be useful here.
- System: This element aims to identify products and/or services that help develop the key action. This requires an analysis of the existing systems. This process can be supported by the internal analysis and external analysis tools of DBZ (2014).

(ii) User research involves identifying all the issues related to the five elements (Fig. 5). To select the method to perform this activity, we used the Hanington (2003) characterisation—traditional, adapted and innovative; accordingly, we arrived at the following possibilities: Kuniavsky's (2003) observations, Portugal's

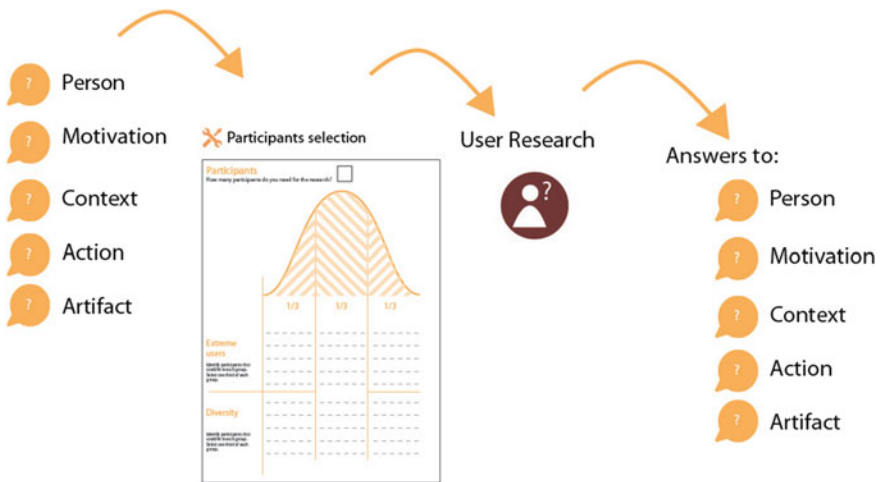


Fig. 5 User research

Project to make the most of food at home






				
Organized profile Awareness profile Worried about money profile Disorganized profile Careless profile Family of independent people Complementary profile 1: he cooks too much food Complementary 2: in case of doubt, food to the trash	At home	Not knowing how much food there is at home Not organizing a food plan that rationalize purchases Not planning purchases and therefore buying more than needed Not calculating rations adequately Not conserving leftovers Inadequate food conservation Not knowing when the food was purchased and, in the end, not knowing if it is in good condition Not distinguishing between the best-before date and the expiration date Not classifying food according with purchase date	Self-reliance Self-esteem Self-fulfilment Closeness Competence Stimulation Popularity Security	Product that indicates food condition Product that helps to preserve food Product to plan purchase dates Product to plan meals Product to plan purchase

Fig. 6 An example of an opportunity matrix adapted from Retegi (2016)

(2013) interviews and Gaver et al.'s (1999) cultural probe, among others. To select the profiles of the type of person to be researched, we recommend Retegi's (2016) people selection tool.

(iii) Finally, insights and opportunities are gathered during the user research, using Retegi's (2016) opportunity matrix (Fig. 6).

### (3) Defining the opportunity

Finally, in this sub-phase, opportunities are created based on the opportunity matrix (Fig. 6). Next, the opportunity to be developed is selected (Fig. 7).

## 4.2 Exploring the Patterns

Based on the motivations of the selected opportunity, behaviour patterns are identified, which will be then transferred to the design brief. This phase comprises four sub-phases (Fig. 8): (1) defining the exploration strategy, (2) gathering meaningful experiences, (3) identifying motivation patterns and (4) choosing the direction and defining the design brief.

### (1) Defining the exploration strategy

This phase involves defining the motivations to be explored and, thereafter, selecting the participants and preparing the interview material to gather information about their experiences (Portugal 2013). Some sample questions used for the exploratory interview are provided below:

- Have you been through a situation in which you made the most of all the food you had at home? How was the experience?



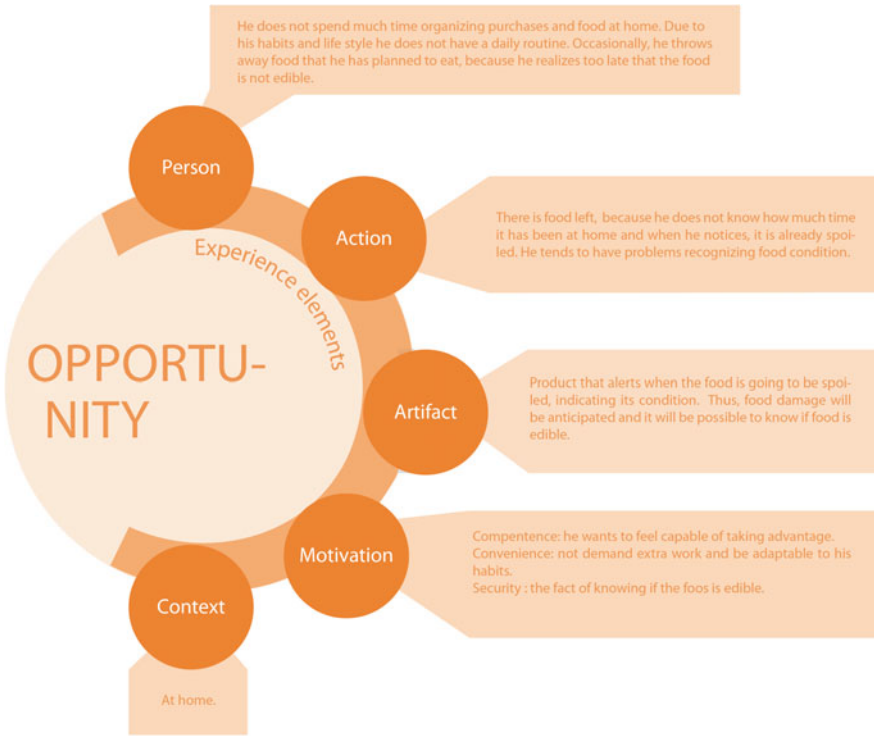


Fig. 7 Opportunity definition (Aramburu 2015)

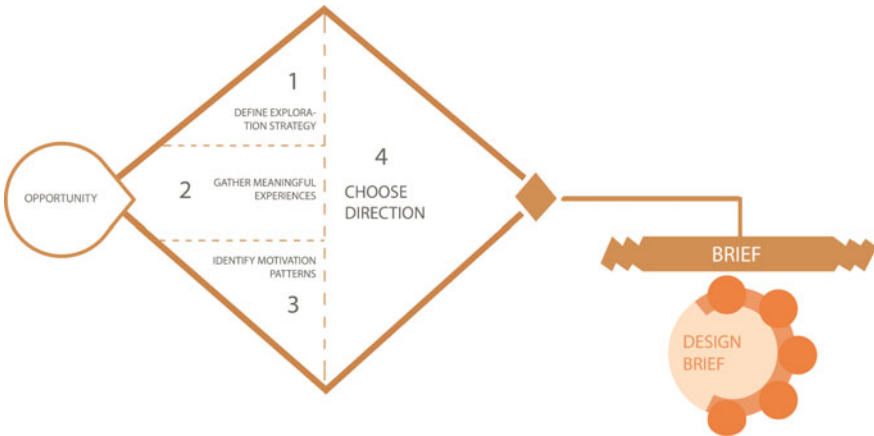


Fig. 8 Exploring the patterns

- Think about situations in your life where you felt competent.
- What are the negative situations that made you feel incompetent, uncertain and uncomfortable?

(2) Gathering meaningful experiences

This involves conducting interviews with the target user profiles in order to collect information about users' experiences and motivations, which form the main purpose of the exploration. It is advisable to record the interviews and later transcribe them, incorporating the meaningful experiences and patterns observed from the information obtained.

(3) Identifying the motivation patterns

After collecting data from the users, the following steps need to be taken (Fig. 9): (i) identifying experiences that describe the same principle (pattern) of behaviour, (ii) establishing the general rule by verbalizing the principal sequence of the pattern and (iii) describing the pattern. As a tool to support this exploration, a meaningful experiences and patterns template is used.

(4) Choosing the direction

First, possible project directions are defined through a creative process. Next, one direction is selected, which then takes the form of a design brief. This brief comprises five elements and patterns (Fig. 10). To choose the direction, different multi-criteria methods can be used (Justel et al. 2007b).

### 4.3 Ideation

Based on the design brief, product and/or service concepts are created, which fulfil the motivations of the target group. This phase comprises three sub-phases (Fig. 11): (1) generating concepts, (2) creating prototypes and (3) assessing and selecting the final concept.

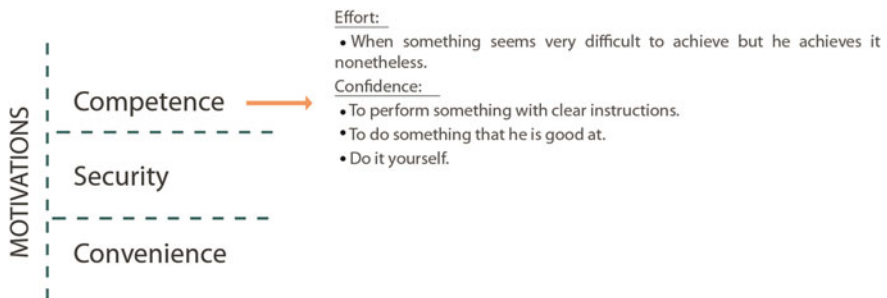


Fig. 9 An example of pattern identification, as per Aramburu (2015)

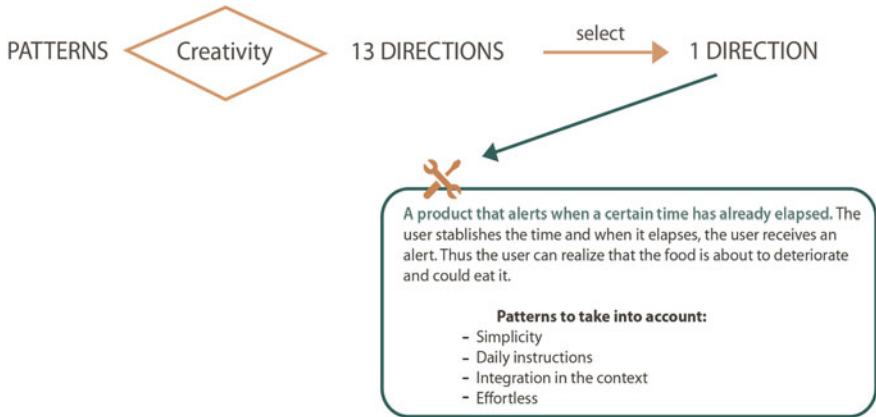


Fig. 10 An example of choosing a direction, as per Aramburu (2015)

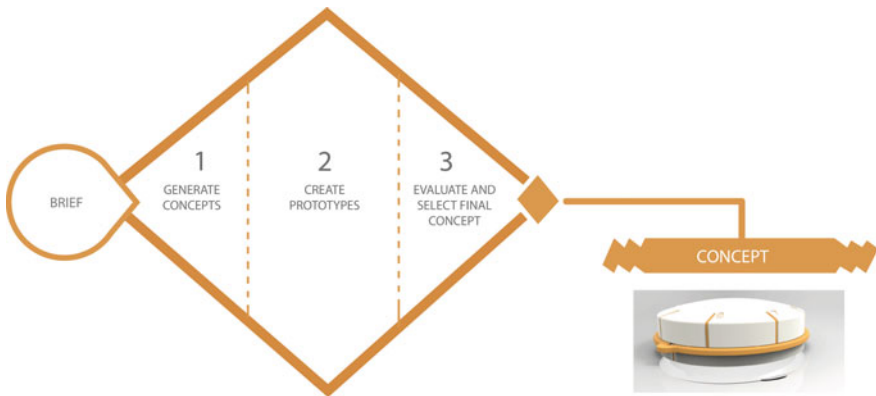


Fig. 11 The ideation phase

(1) Generating concepts

In this sub-phase, concepts are generated to seek answers on the design brief, including the motivation patterns identified in the previous step. Using the experience concept tool (Retegi 2016), the design team considers different scenarios (Fig. 12). In this manner, the concepts and types of interactions can be detailed to ultimately visualize the experience through simplified sketches or storyboards.

(2) Creating prototypes

This sub-phase involves making a decision on the aspects of the concept that should be evaluated and how the assessment will be performed. Different techniques or tools are available for this purpose, such as sketches, storyboards, videos and rapid prototyping.

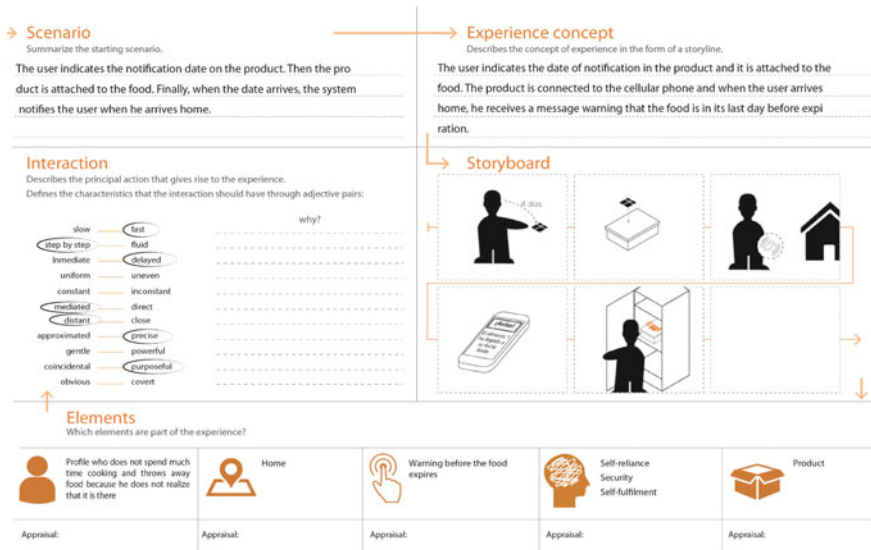


Fig. 12 Concept of experience (Retegi 2016)

### (3) Assessing and selecting the final concept

In this sub-phase, concepts are assessed in order to select the one that will be developed in detail. The questionnaire by Sheldon et al. (2001) is proposed for this purpose, along with other methods, techniques and tools, such as the multi-criteria methods of conceptual evaluation (Justel et al. 2007a), questionnaire panas-X (Watson and Clark 1999), the ‘eyeface’ kit (Lasa 2015) and interviews (Portugal 2013).

After performing the assessment with the target user profile, the concept that best fits the design brief is selected.

## 5 Conclusions

As observed previously, the MOTIVA-PRO guide represents an innovative approach where product and/or service development is based on the motivations and specific needs (security, popularity, etc.) of users with respect to their everyday activities. The methodology described in this paper involves HCD tools. This paper encourages the involvement of different stakeholders and aspects of psychology as the core elements of the project. Thus, in designing new products and services, it reflects the user’s true motivations in purchasing the product or service.

The guide seeks to generate a large number of opportunities and new concepts that can be converted into a portfolio of new products and services. The exploration phase, which involves the five elements of experience (person, motivation, action, context

and system), enables a better understanding of the target users. It also centres user research on the specific aspects that need to be solved or known. This is key to market success. The guide has been tested in an academic setting in four cases: reduce food waste at home (Lasa et al. 2015), urban mobility using bicycles, monitoring senior citizens and new ideas for urban mobility. However, none of the developed systems have been launched in the market; having said that, the product that was designed to make the most of food at home is protected through a utility model. The results have been positive and students have considered the new approach to be quite useful. They highlighted the fact that the guide facilitates an analysis of the convergences and divergences in each phase and enables a deeper exploration. They particularly appreciated that the phase involving the exploration of users' motivations encourages them to rethink how to approach each of the five elements.

The industry in Gipuzkoa, Spain, is currently experiencing a knowledge transfer. Companies in different sectors—machinery tools, elevation, etc.—have started to experiment with the guide. Following the experimentation, any necessary modifications to the guide will be considered in order to facilitate its implementation in the industry. As authors like Simonchik et al. (2015) and Iriarte (2016) state, in the business-to-business (B2B) context, innovative HCD tools need to be adapted so that they can be implemented.

**Acknowledgements** The authors would like to acknowledge the funding received from the 'Programa para la promoción de Gipuzkoa como un territorio que aprende' programme of the Diputación Foral of Gipuzkoa.

## References

- Anderson S (2007) Creating pleasurable interfaces: getting from tasks to experiences. Retrieved on 22 July 2017 from: <https://es.slideshare.net/stephenpa/creating-pleasurable-interfaces-getting-from-tasks-toexperiences/85>
- Aragall F, Montaña J (2012) Universal design. The HUMBLES method for User-centred Business, Gower, Burlingtone
- Aramburu E (2015) Diseño de nuevos productos para aprovechar más la comida en el hogar. Proyecto fin de grado en ingeniería en diseño industrial y desarrollo de producto. Mondragon Unibertsitatea
- Ardèvol M (2006) Tendències de Futur i Noves Realitats. Informe Anual de l'Observatori de Mercats Exteriors. Barcelona, COPCA
- Buzan T (1996) The mind map book. Plume, New York, USA
- BuzzmanTV (2013). Milka - Last Square. Available via DIALOG <http://youtu.be/H6NWTJyWHqc>. Accessed 8 May 2017
- Chong A (2012) Korea - Coca Cola dance vending machine (Feat 2PM). Available via DIALOG. <http://youtu.be/YDg6kG1pUGs>. Accessed 8 May 2017
- Curedale R (2013) Service design: 250 essential methods. Design Community College, California
- DBZ (2014) Metodología para la Innovación centrada en el usuario. Available via DIALOG from <http://dbz.mondragon.edu/es/imagenes/metodologia-dbz>. Accessed 8 May 2017
- Diller S, Shedroff N, Rhea D (2008) Making meaning: how successful businesses deliver meaningful customer experiences. New Riders, San Francisco, USA

- Eckoldt K, Knobel M, Hassenzahl M, Schumann J (2012) An experiential perspective on advanced driver assistance systems. *Inf Technol* 54(4):165–171
- Futurebrand (2012) The future of coffee experiences. Available via DIALOG <http://www.futurebrand.com/images/uploads/clients/casestudies/Nespresso-Case-Study.pdf>. Accessed 17 Dec 2012
- Gaver WW, Dunne A, Pacenti E (1999) Cultural probes. *Interactions* 7(1):21–29
- Hanington B (2003) Methods in the making: a perspective on the state of human research in design. *Des Issues* 19(4):9–18
- Hassenzahl M (2005) The Thing and I: understanding the relationship between user and product. *Funology* 31–42
- Hassenzahl M (2010) Experience design: Technology for all right reasons synthesis lectures on human-centered. *Informatics* 3(1):1–95
- IDEO (2011) Human-centered design toolkit. Available via DIALOG. <https://www.ideo.com/post/design-kit>. Accessed 8 May 2017
- Iriarte I (2016) La contribución del diseño de servicios a la servitización de la industria manufacturera. Dissertation, Mondragon Unibertsitatea
- Jenkinson A (1994) Beyond segmentation. *J Target, Meas Anal Mark* 3(1):60–72
- Justel D, Pérez Bartolome E, Vidal Nadal R, Gallo Fernández A, Val Jauregui E (2007a) Estudio de los métodos de selección de conceptos. XI Congreso Internacional de Ingeniería de Proyectos. Universidad de Santiago de Compostela, Lugo, 26–28 septiembre 2007
- Justel D, Arriaga E, Vidal R, Franco V, Val E (2007b) Evaluation method for selecting innovative product concepts with greater potential marketing success. In: Bocquet J-C (ed) Proceedings of the 16th international conference on engineering design (ICED), Paris
- Kone (2011) People flow. Available via DIALOG. <http://www.kone.com/shared/people-flow-magazine/2011-1/>. Accessed 8 May 2017
- Kuniavsky M (2003) Observing the user experience: a practitioner's guide to user research. Morgan Kaufmann, San Francisco, CA
- Lasa G (2015) Eyeface: nueva herramienta de evaluación de ideas conceptuales para productos y servicios basados en la experiencia de usuario. Dissertation, Mondragon Unibertsitatea
- Lasa G, Justel D, Retegi A, Aranburu E (2015) Design of a new product to make the most of food at home: An experience design approach. Paper presented at the 1st Ikergazte Conference, Basque Summer University, Durango, 5 May 2015
- Lenz E, Diefenbach S, Hassenzahl M, Lienhard S (2012) Mo. Shared music, shared moment. In: Mamborg L, Pederson T (eds.) Proceedings of the 7th nordic conference on human-computer interaction making sense through design. ACM Press, New York, NY
- Maslow AH (1943) A theory of human motivation. *Psychol Rev* 50:370–396
- Morelli N, Tollestrup C (2007) New representation techniques for designing in a systemic perspective. Paper presented at the Nordes 2007- design inquiries. University of Arts, Crafts and Design, Stockholm, 29–30 May 2007
- Mogensen K (2006) Creative man. Institutet for Fremtidsforskning, Copenhagen
- Phillipswakeupthetown (2010) Philips wake up the town – arctic experiment. Available via DIALOG. <http://youtu.be/wotUrbYs0QI>. Accessed 5 April 2012
- Portugal S (2013) Interviewing users: how to uncover compelling insights. Rosenfeld Media, New York
- Retegi A (2016). Inclusive experience design: una metodología de diseño de experiencias basada en las capacidades de las personas. Dissertation, Mondragon Unibertsitatea
- Retegi A, Justel D, Beitia Nafarrate A, Gorritxategi X (2012) Development of a new design approach for Experience. In 8th International Conference on Design & Emotion. London (UK)
- Sanders E B-N, Dandavate U (1999) Design for experiencing: new tools. In Overbeeke CJ, Hekkert P (eds) Proceedings of the first international conference on design and emotion; TU Delft, The Netherlands
- Sheldon KM, Elliot AJ, Kim Y, Kasser T (2001) What is Satisfying about satisfying events? Testing 10 candidate psychological needs. *J Pers Soc Psychol* 80(2):325

- Simonchik A, Iriarte I, Hoveskog M, Halila F, Justel D (2015) Service design tools for business model innovation in B2B. 29th annual British Academy of Management (BAM) conference. University of Portsmouth, UK, 8–10 Sept 2015
- Wasson C (2000) Ethnography in the field of design. *Hum Organ* 59(4):377–388
- Watson D, Clark LA (1999) The PANAS-X: Manual for the positive and negative affect schedule-expanded form. The University of Iowa. Available via DIALOG. [http://ir.uiowa.edu/cgi/viewcontent.cgi?article=1011&context=psychology\\_pubs](http://ir.uiowa.edu/cgi/viewcontent.cgi?article=1011&context=psychology_pubs). Accessed 8 May 2017

**Part IV**  
**Environmental Engineering and**  
**Management of Natural Resources**



# Combined System UASB+MBR for the Biological Elimination of Emerging Contaminants, Organic Matter and Nutrients in Urban Waste Water



M. J. Moya-Llamas, M. A. Bernal-Romero del Hombre Bueno,  
E. D. Vázquez-Rodríguez, A. Trapote, C. M. López-Ortiz and D. Prats

**Abstract** Conventional purification systems can achieve low efficiency in the removal and/or degradation of emerging contaminants (ECs) which are present in urban waste waters. Although biological aerobic technologies such as membrane bioreactors (MBR) have shown high effectiveness, some compounds are eliminated in a higher degree using anaerobic biological systems. This research is aimed at the study of a system which has all the advantages of both the aerobic and anaerobic biological cleansing, in order to optimize ECs, organic matter and nutrient elimination. To this end, a pilot plant operation has been analyzed, integrated by an Upflow Anaerobic Sludge Blanket reactor (UASB) followed by a MBR with an external submerged configuration. The first phase of this research has been performed with the aerobic biomass in suspension and the second phase with supported biomass. Results confirm the synergic effect of both systems, due to the achievement of a high removal performance of the more persistent contaminants, such as carbamazepine, diclofenac, simazine, atrazine, linuron and terbuthylazine. Regarding organic matter, nitrogen and phosphorus elimination, global yields were close to 98%, 45% y 35% respectively, with a particularly high performance in the supported biomass phase.

**Keywords** UASB · Combined biological systems · Emergent contaminants

---

M. J. Moya-Llamas (✉) · M. A. Bernal-Romero del Hombre Bueno  
E. D. Vázquez-Rodríguez · A. Trapote · C. M. López-Ortiz · D. Prats  
University Institute of Water and Environmental Sciences, University of Alicante,  
Campus de San Vicente del Raspeig, S/N, 03690 San Vicente del Raspeig, Alicante, Spain  
e-mail: mjmoyallamas@telefonica.net

© Springer International Publishing AG, part of Springer Nature 2019  
J. L. Ayuso Muñoz et al. (eds.), *Project Management and Engineering Research*,  
Lecture Notes in Management and Industrial Engineering,  
[https://doi.org/10.1007/978-3-319-92273-7\\_10](https://doi.org/10.1007/978-3-319-92273-7_10)

## 1 Introduction

Requirements on the final quality of effluents, both for their reuse and for their re-entry into the water masses, are increasingly demanding and they force to achieve a very efficient depuration. The Directive 2000/60/EC, or Water Framework Directive, regulates the preservation, improvement and restoration of the water masses' state, preventing their deterioration. To the same effect, the Royal Decree 1620/2007, of December 7, establishes the legal regime on treated water reutilization with the aim of encouraging its reuse and a more efficient use of the hydraulic resources.

Emerging contaminants (ECs) are substances found in the environment in increasing quantities and the consequences of their presence, persistence and bioaccumulation are not thoroughly known. It has become evident that conventional EDARs do not efficiently eliminate all these compounds. The development of aerobic biological systems such as membrane biological reactors (MBR) has brought an important progress in the removal of these types of compounds. In order to improve removal levels of ECs and priority substances, the need arises of complementing these treatments through a combination of processes. Combined biological processes have the advantage of being environmentally sustainable, cheaper than those based in advanced oxidation and have maintenance and control processes that have been studied at length.

In this context, many hybrid or combined configurations arise. Especially interesting, although scarcely studied, is one composed of an anaerobic reactor with a bed of sludge with an upward flow, or Upflow Anaerobic Sludge Blanket (UASB) followed by a membrane biological reactor (MBR) (Buntner 2013).

## 2 Objectives

The main objective of this research is the study of a double anaerobic and aerobic biological treatment for the removal of ECs, organic matter and nutrients from urban waste water. For that purpose a combined UASB-MBR pilot plan has been operated, with the aim of analyzing separately the efficiency of each one of these systems as well as the global system efficiency.

This research also studies the effect of the presence of biomass of different nature in the removal or the degradation of these compounds. This is the case of biomass in suspension and supported biomass, through the introduction of K1 type AnoxKaldnes® biocarriers in the aerobic tank for the second stage of this study. Using respirometric techniques, the process kinetics monitoring and the biomass activity have been performed.

As a secondary objective of this research, the composition and production of biogas generated in the anaerobic reactor has been studied (UASB).

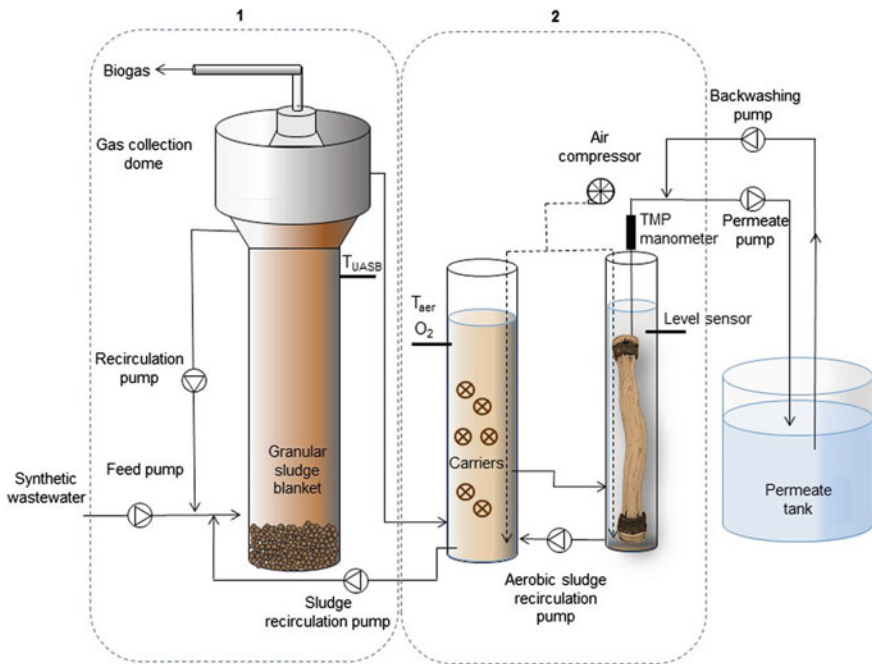
### 3 Methodology

#### 3.1 Experimental Design

The start-up and operation of a combined pilot plant composed by an anaerobic reactor with ascending flow followed by a membrane bioreactor in external submerged configuration has been performed (Fig. 1).

The anaerobic system (1) consisted of an UASB with 25 L of useful volume inoculated with 8 L of fluidized granular sludge that came from an anaerobic reactor UASB which is used to treat waters from a beer industry. The synthetic feed was introduced in the lower end of the reactor, so in its rise it went through the sludge blanket, thus achieving treatment and biogas liberation. The ascent velocity, which is one of the main design parameters in this type of reactors, was maintained within the designed values during the research, by using a pump to recirculate part of the effluent to the lower part of the reactor.

Regarding biogas production, it was collected in the upper part of the anaerobic reactor, with the use of a bell-shaped device, and conducted to a biogas measuring device designed to that effect and based on the displacement of liquid due to the volume occupied by the biogas.



**Fig. 1** 1 Anaerobic UASB reactor, 2 Membrane bioreactor external submerged configuration

The effluent treated in the anaerobic reactor was collected in its upper part and conducted by gravity to the MBR aerobic tank to undergo its aerobic treatment. The bioreactor (2) was comprised by two tanks: an aerobic one with a capacity of 12 L, and a membrane tank with 8 L capacity, which has a microfiltration hollow fiber membrane with 0.4  $\mu\text{m}$  pore size and 0.20  $\text{m}^2$  de filtering surface.

The plant was designed with recirculation between the aerobic tank and the UASB reactor, to achieve its effective operation as a combined plant.

During the first stage, the plant operation was performed with suspended biomass and in the second stage the experimentation was conducted in the same operating conditions but with supported biomass. The aim of these two stages was to assess and compare the efficiency of the ECs, organic matter and nutrients removal in both cases.

The plant was equipped among other devices, with level probes, dissolved oxygen meter, transmembrane pressure meter and temperature sensors, all necessary for monitoring and controlling the main operation parameters. For their continual monitoring, a PC was used with software developed to that effect.

Peristaltic pumps were used both for the plant feeding, and for the different recirculations and for the permeate.

### ***3.2 Start-Up and Operation***

The plant was tuned using the water network, in order to calibrate the flow rates of the pumps, prevent possible leakages and check meters and control elements. Consequently, it was fed in a high organic load with synthetic water prepared according to the following composition for a reference DQO of 1200 mg/L: 47.60 g peptone, 32.59 g meat extract, 0.59 g  $\text{MgSO}_4 \cdot 7 \text{H}_2\text{O}$ , 1.18 g  $\text{CaCl}_2 \cdot 2 \text{H}_2\text{O}$  and 2.07 g NaCl. In order to maintain bicarbonetic alkalinity and the buffer effect at the required levels for the anaerobic reactor, the previous formula was complemented with 3 g  $\text{NaHCO}_3$  y 1.5 g  $\text{Na}_2\text{CO}_3$ .

The combined plant's main operational parameters are shown in Table 1.

After the start-up phase was completed, on day 56 of the operation phase, the addition of studied ECs began and it was performed in a continuous manner in the synthetic feed, until the end of the experimentation. Subsequently, in the second phase of the operation, the improvement of performance in the elimination/reduction of the ECs, organic matter and nutrients was analyzed. This improvement was due to the incorporation of a blanket to the MBR active sludge system in external configuration of the combined plant UASB-MBR. The chosen filling was the mod. K1 de AnoxKaldnes™ and the filling ratio was 35%, based on the research by Martín-Pascual et al. (2012).

**Table 1** Main operational parameters of the UASB-MBR pilot plant

Reactor	Parameters	
UASB anaerobic reactor	T (°C)	28.3–31.2
	Q <sub>a</sub> (L/h)	0.67
	Q <sub>r</sub> UASB (L/h)	1.40
	pH <sub>affluent</sub>	6.98–8.13
	pH <sub>effluent</sub>	6.94–7.68
	HRT (h)	37
	SRT (d)	90
	OLR (kg DQO/m <sup>3</sup> d)	0.60–0.80
	V <sub>asc</sub> (m/h)	0.103
Membrane bioreactor	T (°C)	20.5–32.3
	PTM (bar)	≤ 0.320
	MLSS (mg/L)	475–1225
	Q <sub>a</sub> (L/h)	0.669
	Q <sub>r</sub> /Q <sub>p</sub> (%)	37.40
	pH <sub>affluent</sub>	6.94–7.68
	pH <sub>effluent</sub>	6.41–7.39
	Flux (L/m <sup>2</sup> h)	5.35
	C <sub>m</sub> (kg DQO/kg MLSS d)	0.33–0.89
	HRT (h)	29.90
	SRT (d)	90

### 3.3 Characterization and Optimal Dose of ECs and Priority Substances

A mix of 30 different organics contaminants were added to the feed: organochlorines, triazines, pharmaceuticals, parabens, hormones, surfactants and plasticizer (Table 2).

#### 3.3.1 Activated Sludge Inhibition Tests Using Respirometric Techniques

Respirometric techniques can be used for the study on the respiration inhibition in activated sludge. This is made to evaluate toxicity in waste waters, both for heterotrophic bacteria and for nitrifying bacteria (Riedel et al. 2002). Using the test for respiration inhibition on activated sludge (OECD 209 1993), it is possible to assess the effect on microorganisms of the compounds that are being studied by measuring their inhibition rate in defined conditions.

To establish the optimal amount of ECs and priority substances to be introduced in the synthetic feed, toxicity tests were performed. For this end, the sludge

**Table 2** Organic contaminants used in this study

Compound	CAS registry number	Formula
<i>Organochlorines</i>		
Alachlor	15972-60-8	C <sub>14</sub> H <sub>20</sub> ClNO <sub>2</sub>
Lindane	58-89-9	C <sub>6</sub> H <sub>6</sub> Cl <sub>6</sub>
Heptachlor	76-44-8	C <sub>10</sub> H <sub>5</sub> Cl <sub>7</sub>
Heptachlor epoxide	1024-57-3	C <sub>10</sub> H <sub>5</sub> Cl <sub>7</sub> O
α-endosulfan	959-98-8	C <sub>9</sub> H <sub>6</sub> Cl <sub>6</sub> O <sub>3</sub> S
β-endosulfan	33213-65-9	C <sub>9</sub> H <sub>6</sub> Cl <sub>6</sub> O <sub>3</sub> S
Dieldrin	60-57-1	C <sub>12</sub> H <sub>8</sub> Cl <sub>6</sub> O
Endrin	72-20-8	C <sub>12</sub> H <sub>8</sub> Cl <sub>6</sub> O
Isodrin	465-73-6	C <sub>12</sub> H <sub>8</sub> Cl <sub>6</sub>
o,p'-DDD	53-19-0	C <sub>14</sub> H <sub>10</sub> Cl <sub>4</sub>
p,p'-DDD	72-54-8	C <sub>14</sub> H <sub>10</sub> Cl <sub>4</sub>
Trifluraline	1582-09-8	C <sub>13</sub> H <sub>16</sub> F <sub>3</sub> N <sub>3</sub> O <sub>4</sub>
Linuron	330-55-2	C <sub>9</sub> H <sub>10</sub> Cl <sub>2</sub> N <sub>2</sub> O <sub>2</sub>
<i>Triazines</i>		
Simazine	122-34-9	C <sub>7</sub> H <sub>12</sub> ClN <sub>5</sub>
Atrazine	1912-24-9	C <sub>8</sub> H <sub>14</sub> ClN <sub>5</sub>
Terbutylazine	5915-41-3	C <sub>9</sub> H <sub>16</sub> ClN <sub>5</sub>
<i>Pharmaceuticals</i>		
Ibuprofen	15687-27-1	C <sub>13</sub> H <sub>18</sub> O <sub>2</sub>
Triclosan	3380-34-5	C <sub>12</sub> H <sub>7</sub> Cl <sub>3</sub> O <sub>2</sub>
Carbamazepine	298-46-4	C <sub>15</sub> H <sub>12</sub> N <sub>2</sub> O
Diclofenac	15307-86-5	C <sub>14</sub> H <sub>11</sub> Cl <sub>2</sub> NO <sub>2</sub>
<i>Parabens</i>		
Methyl-paraben	99-76-3	C <sub>8</sub> H <sub>8</sub> O <sub>3</sub>
Ethyl-paraben	120-47-8	C <sub>9</sub> H <sub>10</sub> O <sub>3</sub>
Propyl-paraben	94-13-3	C <sub>10</sub> H <sub>12</sub> O <sub>3</sub>
Butyl-paraben	94-26-8	C <sub>11</sub> H <sub>14</sub> O <sub>3</sub>
<i>Hormones</i>		
Estrone	53-16-7	C <sub>18</sub> H <sub>22</sub> O <sub>2</sub>
17-α-ethinyl estradiol	57-63-6	C <sub>20</sub> H <sub>24</sub> O <sub>2</sub>
17-β-estradiol	50-28-2	C <sub>18</sub> H <sub>24</sub> O <sub>2</sub>
<i>Surfactants</i>		
4-octylphenol	1806-26-4	C <sub>14</sub> H <sub>22</sub> O
4-tert-octylphenol	140-66-9	C <sub>14</sub> H <sub>22</sub> O
<i>Plasticizer</i>		
Bisphenol A	80-05-7	C <sub>15</sub> H <sub>16</sub> O <sub>2</sub>

maximum respiration rate or variation was studied ( $R_{S,p \max}$ ) using a very biodegradable substrate and analyzing its evolution after being subjected to the addition of consecutive doses of the 30 studied organic contaminants' mix in different concentrations ( $C_1 = 4 \mu\text{g/L}$ ,  $C_2 = 10 \mu\text{g/L}$ ,  $C_3 = 30 \mu\text{g/L}$  y  $C_4 = 60 \mu\text{g/L}$ ). The sludge was not pre-adapted and the test was performed in endogenous conditions. As a substrate, 100 mg of  $\text{NH}_4\text{Cl}$  and 500 mg of sodium acetate dissolved in 10 mL of distilled water so the substrate quantity was not a process constraining factor. The device used was a respirometer model BM-T of Surcis, S.L.

The inhibitory effect of the added contaminants doses was determined as a function of the activated sludge respiration variation descent (Eq. 1):

$$\% \text{ Inhibición} = (1 - R_{S,p}/R_{S,p\max}) \cdot 100 \tag{1}$$

Being:

$R_{S,p}$  ( $\text{mg O}_2/\text{g MLSSV} \cdot \text{h}$ ): Variation on the oxygen consumption of the sample, as a function of the microorganisms concentration present in the mixed liquor.

$R_{S,p \max}$ : Variation on the maximum oxygen consumption, as a function of the microorganisms concentration present in the mixed liquor or Saturation oxygen consumption rate.

Figure 2 shows the results of the inhibition test on a volume of one liter of inoculum sludge through the successive addition of increasing ECs doses.

While the compound mix introduction at the two first concentrations ( $C_1$  and  $C_2$ ) did not involve any inhibition in the oxygen consumption rate referred to the microorganisms present in the sample, concentration  $C_3$  produced an inhibition >19% and  $C_4$ , with an 58.7% inhibition, produced a dose higher than the lethal one ( $DL_{50}$ ).

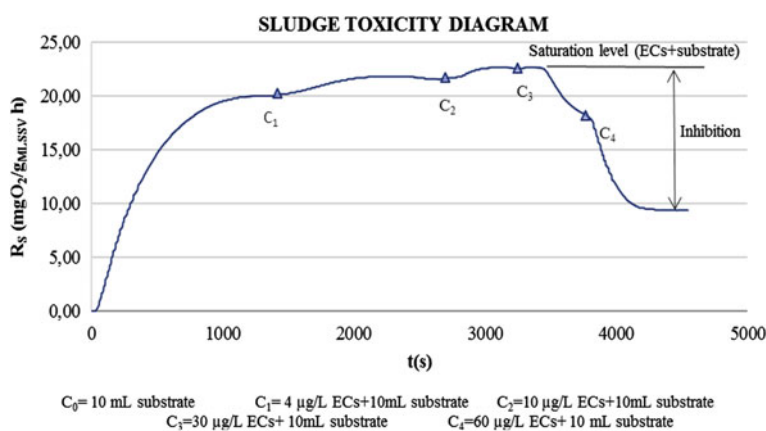


Fig. 2  $R_s/t$  diagram for the determination of the respiration inhibition of the aerobic sludge on the combined plan for different ECs concentrations

Based on the results,  $C_2 = 10 \mu\text{g/L}$  was chosen for each one of the compounds to be introduced. It has been proven that this dose did not produce inhibition of the microbial activity. And it is a dose high enough for, once subjected to the double biological treatment using UASB-MBR, the remaining ECs concentrations in the effluent to be higher than the detection limits of the analyzing equipment GC-MS (GC: Agilent 7890 and MS: Agilent 5975).

### ***3.4 Characterization and Optimal Dose of ECs and Priority Substances***

For the implementation of the analytical determinations, daily samples were extracted from the synthetic feed, the anaerobic UASB reactor effluent, the MBR reactor's aerobic tank mixed liquor and the permeate at the plant output.

The aerobic and the anaerobic reactors temperature, the oxygen dissolved in the MBR and the trans-membrane pressure (PTM) were registered in a continuous manner using software developed to that effect. For PTM measurement, a device mod. TPR-14 of DESIN Instruments was used. The critical flow was determined by the Flux-step method developed by Van der Marel et al. (2009). pH and electrical conductivity measurement were performed using a CRISON mod. Basic 20 + analyzer, equipped with a temperature compensation electrode.

The measurement of the Chemical Oxygen Demand, total nitrogen ( $N_T$ ), Total phosphorus ( $P_T$ ), nitrites ( $\text{NO}_2$ ), nitrates ( $\text{NO}_3$ ), ammonium ( $\text{NH}_4$ ) and sulfates ( $\text{SO}_4$ ) was performed using Machery-Nagel cuvette tests, digested and measured using the Merck TR300 digester and the Machery-Nagel spectrophotometer NANOCOLOR@500D respectively.

For the measurement of the overall amount of carbon present in each sample, a Simadzu mod. TOC-500 A equipment was used.

Suspended solids concentration in the mixed liquor was determined using gravimetric methods covered by Standard methods for the examination of water and wastewater (APHA 1992). Biofilm density, a parameter which indicates the amount of solids adhered to the biocarriers in the biological reactor, was determined by previously separating it from the plastic supports using centrifugation. Using the filling ratio and knowing the number of supports or carriers per liter, the amount of solids was determined (Plattes et al. 2008).

Regarding biogas generated in the anaerobic reactor UASB, periodic samples were taken for measurement using Tedlar® bags. To determine its composition, the GEOTECH mod. Biogas 5000 analyzer was used.

Toxicity tests and respirometric activity control of the aerobic sludge were performed using a Surcis respirometer mod. BM-T, S.L.

Residual ECs determination in the treated effluent for each system and for the global system UASB-MBR was performed by solid phase extraction, concentration



and subsequent reconstitution and analysis using GC-MS equipment (GC: Agilent 7890 y MS: Agilent 5975).

## 4 Results and Discussion

### 4.1 Organic Matter Removal

Below, efficiency of organic matter removal results is reviewed. This was made based on the chemical oxygen demand in the influent and the effluent of each one of the systems (UASB y MBR) individually, as well as the global removal of the combined plant UASB-MBR without biocarriers (Fig. 3) and with synthetic feed prepared for DQO = 1200 mg O<sub>2</sub>/L.

Stage 1: Non-supported biomass.

The plant operated during 83 days with a high load and without biocarriers. Figure 3 resumes the result of the organic mass removal performance of the individual systems and the combined system UASB-MBR subjected to a high load without biocarriers, both at the start-up and after the ECs introduction.

The organic matter's removal efficiency in the start-up phase of the anaerobic system (UASB) reached between 64.6 and 83.6%, with a specific biogas production rate which was practically constant of 0.29 m<sup>3</sup> biogas kg DQO<sup>-1</sup> and a methane content of 68–82%.

After the studied compounds addition to the synthetic feed, the UASB efficiencies sharply fell, showing a high sensitivity to the added compounds. At this moment, the biogas production in the anaerobic system also fell up to practically zero.

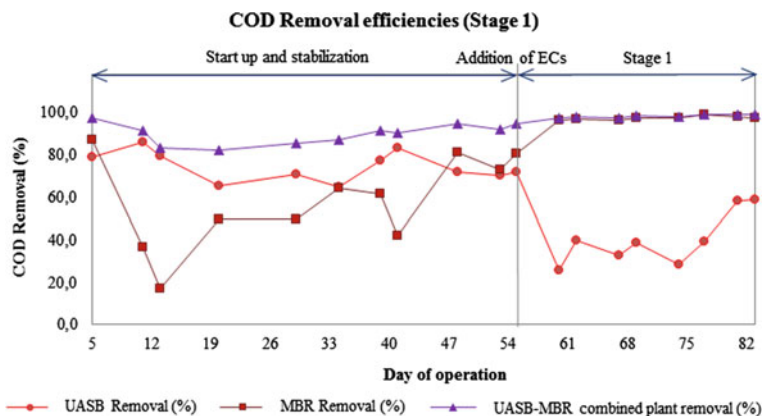


Fig. 3 Removal/degradation efficiencies of organic matter without biocarriers (stage 1)

When this important efficiency decrease occurred on the UASB system's DQO elimination, the outbound effluent showed a higher DQO. Since this effluent was then subjected to the aerobic treatment in the MBR, the mass load entering this system (MBR) increased. As a consequence, an increase of the suspended solids occurred in the mixed liquor, fostering the DQO elimination efficiencies in the MBR. However, synergies reached between both systems allowed that the combined UASB-MBR plan could maintain a very stable efficiency, with values higher than 94.5%, an average value of 98.0% and maximum values of 99.3%.

- Stage 2: Supported biomass.

Figure 4 shows organic matter removal efficiencies in the individual systems as well as in the combined UASB-MBR system, after biocarriers were introduced in the aerobic tank of the membrane bioreactor subjected to synthetic feed with the ECS in high organic load.

From the results analysis, it can be deduced that there are not significant differences in the organic matter removal efficiencies after biocarriers were introduced. This can be because the anaerobic treatment (UASB) reached in the second stage efficiencies far higher than those obtained without biocarriers, which confirms that the biomass adapted to the contaminants that were added and also that the UASB anaerobic system stabilization requires more time than that of the MBR, or otherwise, that the biocarriers do not improve organic matter removal.

UASB-MBR combined system efficiencies were practically the same as in stage 1, with a maximum removal of 99.5%, average of 97.6% and minimal of 94.3%.

Due to the aerobic biomass adaptation to the introduced organic compound, the system could restore the initial biogas production and quality.

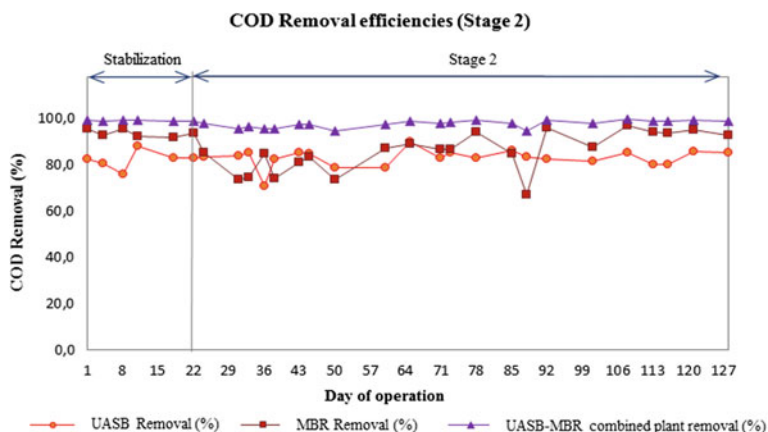


Fig. 4 Removal efficiencies of organic matter with supported biomass (stage 2)

## 4.2 *Nutrients Removal*

- $N_T$  removal.

The average efficiencies of total nitrogen removal in stage 1 (without biocarriers) were 40.4%, reaching a maximum value of 57%. This was obtained mainly in the MBR aerobic system.

The introduction of biocarriers in the aerobic MBR reactor, entailed an important improvement regarding nutrients removal, reaching a maximum efficiency of 65.4% in total nitrogen removal, 8.4% higher than the one obtained with not supported biomass.

Regarding the forms in which nitrogen was found in the system, after the anaerobic treatment it was found mostly in its ammoniacal form, while after filtering in the membrane bioreactor, it was found basically in the form of nitrates, which confirms previous research results (Qiu et al. 2013).

- $P_T$  removal.

Total phosphorus removal reached a maximum value of 45.0% in the combined system, with an average of 27.0% with not supported biomass. As in the  $N_T$  case, this removal was basically reached with the aerobic treatment (MBR).

The biocarriers influence significantly improved the total phosphorus removal, with maximum values near 60.0% and an average efficiency of 35.0%, a 8.0% higher than the efficiency reached without biocarriers.

## 4.3 *ECs and Priority Substances Removal*

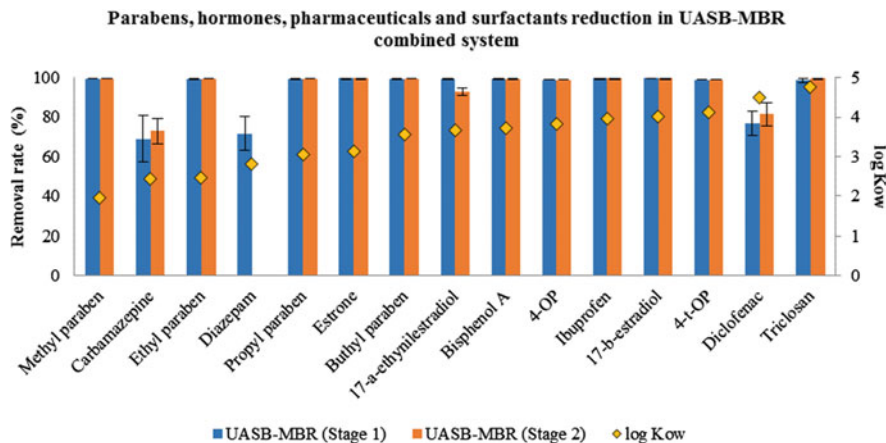
Below, the results analysis of the effluents treated in the combined plant UASB-MBR in both stages (with and without biocarriers), analyzed with gas chromatography coupled with mass spectrometry. Results are shown in Figs. 5 and 6.

Results shown in Fig. 5 indicate that certain compounds as all studied parabens, hormones estrona and 17- $\beta$ -estradiol, ibuprophen, surfactants and bisfenol A are reduced by more than 99% by the combined system with aerobic biomass, both not supported and supported.

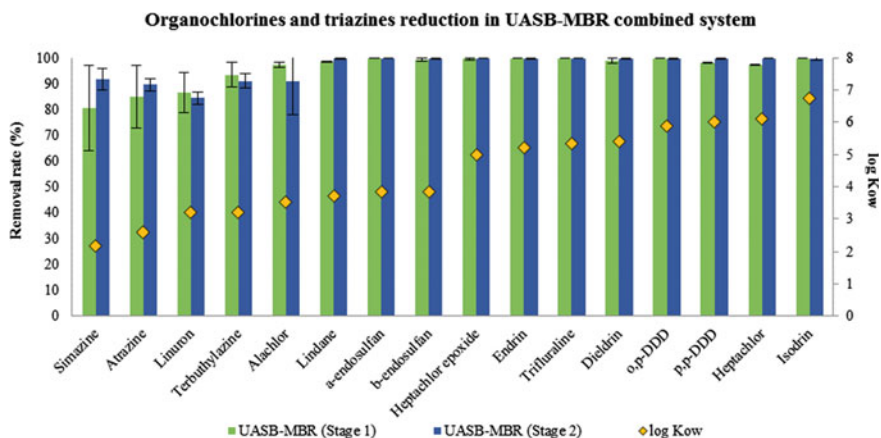
Hormone 17- $\alpha$ -etinil estradiol was removed in different proportions with supported biomass (92.9%) and non-supported biomass (99.3%).

Triclosán was practically eliminated. Removal rate reached with biocarriers (99.7%) was higher than without biocarriers (98.7%).

Diazepam and carbamazepine proved to be more recalcitrant compounds, with reductions approaching 70% without biocarriers and slightly higher for carbamazepine with biocarriers (73.0%). Diazepam was removed by 71.6% but it could not be analyzed in the supported biomass stage for health restrictions.



**Fig. 5** Removal/reduction rate comparison for parabens, hormones, pharmaceuticals, surfactants and plasticizer in the UASB-MBR system



**Fig. 6** Removal rate comparison for removal/reduction of organochlorines and triazines in the UASB-MBR system

Diclofenac was also partially removed in stage 1 (76.8%), and its removal was improved by 5%. When biocarriers were added.

Figure 6 overviews the different removal/reductions reached in stages 1 and 2, in organochlorines and triazines.

In the case of the following compounds, a degradation of about 99% both in stage 1 and in stage 2 was observed: lindane, endrin, trifluraline, dieldrin, o,p-DDD, isodrin, α-endosulfan and heptachlor epoxide. Compounds degraded about 97% without biocarriers were p,p-DDD, heptachlor y alachlor. All compounds removal improved in the supported biomass stage (removing more than 99% in all cases).

The more resistant compounds to the anaerobic-aerobic double treatment were triazines and linuron. Nevertheless, all compounds reached removal rates near 90% in the supported aerobic biomass operation stage, with the exception of linuron, which, with a removal rate of 84.4%, was the most difficult compound to eliminate.

In any case, the operation with biocarriers implied a significant improvement regarding the removal of the more persistent compounds to the aerobic and anaerobic biological treatments. In the case of simazine, 11% higher removal rates were obtained in the case of supported biomass, compared to the non-supported one. The atrazine removal increased by 5% with biocarriers and this fact can justify the use of biocarriers in the aerobic treatment.

## 5 Conclusions

This research has proven that the combination of biological treatments (in this case, aerobic-anaerobic) can be an effective solution for the degradation/reduction of ECs and priority substances, organic matter and nutrients present in waste water.

The pilot plant composed of an upflow sludge blanket anaerobic reactor, combined with a membrane bioreactor (UASB-MBR) has proven to be a robust system, which, once stabilized, was very resilient to the presence of ECs and priority substances.

Nutrients removal was improved by the presence of biocarriers, which increased the removal rates of total nitrogen and total phosphorus about 8%. This is especially important regarding discharge requirements in sensitive zones.

The anaerobic system proved to be a sustainable system which, when subjected to high organic loads ( $ORL = 0.6\text{--}0.8 \text{ kg DQO/m}^3 \text{ d}$ ), offers a high specific rate of biogas production ( $0.29 \text{ m}^3 \text{ biogas kg DQO}^{-1}$ ) with a good quality (68–82% methane content).

Regarding the removal of emergent contaminants and the studied priority substances, for ten of the thirteen organochlorinated compounds analyzed, removal rates above 98% without biocarriers were obtained. Organochlorinated compounds partially removed in stage 1 were alachlor (97.4%) and heptachlor (97.5%); however, biocarrier presence improved the removal of the latest in an average percentage higher than 2%. The more persistent organochlorinated compound was linuron, with removal rates of 86.5% without biocarriers and 84.3% with biocarriers. Triazines were compounds with high resistance to biological treatments, with average removal rates of about 86% without biocarriers and 90% with biocarriers. In this case, it could be noted that the presence of supported biomass considerably improved the removal rate. Parabens, hormones, surfactants, plasticizer and pharmaceuticals ibuprofen and triclosan reached removal rates higher than 99% without supported biomass, so the influence of the biocarriers in the second stage was not significant. Pharmaceuticals carbamazepine, diazepam and diclofenac were the most persistent, with removal rates of 69.0%, 71.6% y 76.8% respectively without biocarriers, but with supported biomass this percentages improved about 4%.

Aerobic-anaerobic biological double treatment (UASB-MBR) is a solution for the degradation/reduction of a large number of emerging contaminants and priority substances of different nature. This system can also increase its efficiency in the removal of the more persistent ECs, through the addition of biocarriers in the MBR, at the same time improving the removal rates of nutrients of an individual biological treatment.

## References

- APHA (1992) Standard methods for the examination of water and wastewater, 18th edn. American Public Health Association, Washington
- Buntner D (2013) Combined UASB-MBR system for the treatment of low-strength wastewater at ambient temperatures
- Directive 2000/60/EC of the European Parliament and of the Council of 23 October 2000 establishing a framework for Community action in the field of water policy. OJL 327(1–73)
- Martín-Pascual J, Lopez-Lopez A, Cerdá A, González-López J, Hontoria E, y Poyatos JM (2012) Comparative kinetic study of carrier type in a moving bed system applied to organic matter removal in urban wastewater treatment. *Water Air Soil Pollut* (223):1699–1712. <https://doi.org/10.1007/S11270-011-0976-5>
- OECD Method 209 (1993) Activated sludge, respiration inhibition test. OECD Guidelines for testing of chemicals. OECD, Paris, France
- Plattes M, Henry E, Schosseler PM (2008) A zero-dimensional biofilm model for dynamic simulation of moving bed bioreactor systems: model concepts, Peterson matrix, and application to a pilot-scale plant. *Biochem Eng J* 40(2):392–398
- Qiu G, Song Y, Zeng P, Duan L, Xiao S (2013) Combination of upflow anaerobic sludge blanket (UASB) and membrane bioreactor (MBR) for berberine reduction from wastewater and the effects of berberine on bacterial community dynamics. *J Hazard Mater* 246–247(0):34–43
- Riedel K, Kunze G, König A (2002) Microbial sensor son a respiratory basis for wastewater monitoring. *Adv Biochem Eng Biotech* 75:81–118
- van der Marel P, Zwijnenburg A, Kemperman A, Wessling M, Temmink H, Van Der Meer W (2009) An improved flux-step method to determine the critical flux and the critical flux for irreversibility in a membrane bioreactor. *J Membr Sci* 332(1):24–29

# Identification of Environmental Risk Areas Using Pollution Indexes and Geographic Information Systems



J. A. Acosta, M. D. Gómez-López, A. Faz, R. Zornoza  
and S. Martínez-Martínez

**Abstract** The objective of this study was to demonstrate the usefulness of geographic information systems (GIS) and pollution indices to identify environmental risk areas affected by metals. The study area was located in the city of Murcia and its surroundings (SE Spain). The concentrations of Cr, Zn, Cu, Pb, Mn, Ni and Cd in 221 soil samples were determined, and five pollution indices calculated. After an analysis of each index and a comparison among them, the pollutant load index (PLI) was selected for the following reasons: (1) it provided a good spatial distribution of the areas of highest risk, (2) all metals contributed in a similar way to the index value, and (3) the index includes background concentrations in its calculation, which allowed to determine the level of metal enrichment. After selecting the index, GIS was used to create a spatial distribution map adjusting the parameters to obtain an adequate delimitation of the areas with the highest environmental risk. As a result, eight areas were identified. Therefore, the calculation of pollution indices and subsequent integration into a GIS is an appropriate and effective tool for rapid identification of environmental risk areas by presence of metals.

**Keywords** SIG · Metals · Environmental risk · Murcia

## 1 Introduction

Soil pollution by heavy metals is a global environmental concern (Ferguson and Kasamas 1999), with a higher incidence in the industrialized countries than in developing ones. The adverse effects of metals are due to their toxicity, persistence and accumulation in biotic and abiotic systems (Ferreira-Baptista and De Miguel 2005; Ahmed and Ishiga 2006). This global problem affects many territories in the

---

J. A. Acosta (✉) · M. D. Gómez-López · A. Faz · R. Zornoza · S. Martínez-Martínez  
Grupo de Investigación “Gestión, Aprovechamiento y Recuperación de Suelos y Aguas”,  
Universidad Politécnica de Cartagena, Paseo Alfonso XIII, 478, 30203 Cartagena, Murcia,  
Spain  
e-mail: ja.acosta@upct.es

© Springer International Publishing AG, part of Springer Nature 2019  
J. L. Ayuso Muñoz et al. (eds.), *Project Management and Engineering Research*,  
Lecture Notes in Management and Industrial Engineering,  
[https://doi.org/10.1007/978-3-319-92273-7\\_11](https://doi.org/10.1007/978-3-319-92273-7_11)

word, which requires, by the public administration, a response to evaluate and reduce, if necessary, the impacts on the population and ecosystems.

Metals come from a large number of anthropogenic sources, including agricultural activities (Gäblere and Schneider 2000; Navas and Lindhorfer 2003), urban activities (Chronopoulos et al. 1997; Salviaggio et al. 2002), industrial activities (Govil et al. 2001; Abollino et al. 2002) and mining areas (Conesa et al. 2007, 2009; Zanuzzi et al. 2009; Ottenhof et al. 2007). In some cases, these activities are close to each other, with interactions among them, being difficult to identify the sources of metals and to determine which areas are affected. In order to solve this problem, pollution indices can be used, being a good and powerful tool to process and analyze a large amount of environmental information (Ramos et al. 2002), facilitating the interpretation of the huge amount of data. In addition, Geographic Information Systems (GIS) can be used to spatially visualize these indices and to create distribution maps, in order to identify the most affected areas (Caeiro et al. 2005), which could be studied in detail by means of a specific sampling and analysis.

## 2 Objectives

The objective of this study was to demonstrate the usefulness of Geographic Information Systems (GIS) and pollution indices for the identification of environmental risk areas in an urban environment, indicating the degree and extension of affected areas, which will be used as a basis for detailed studies in order to propose measures to control and reduce existing environmental risks.

## 3 Methodology

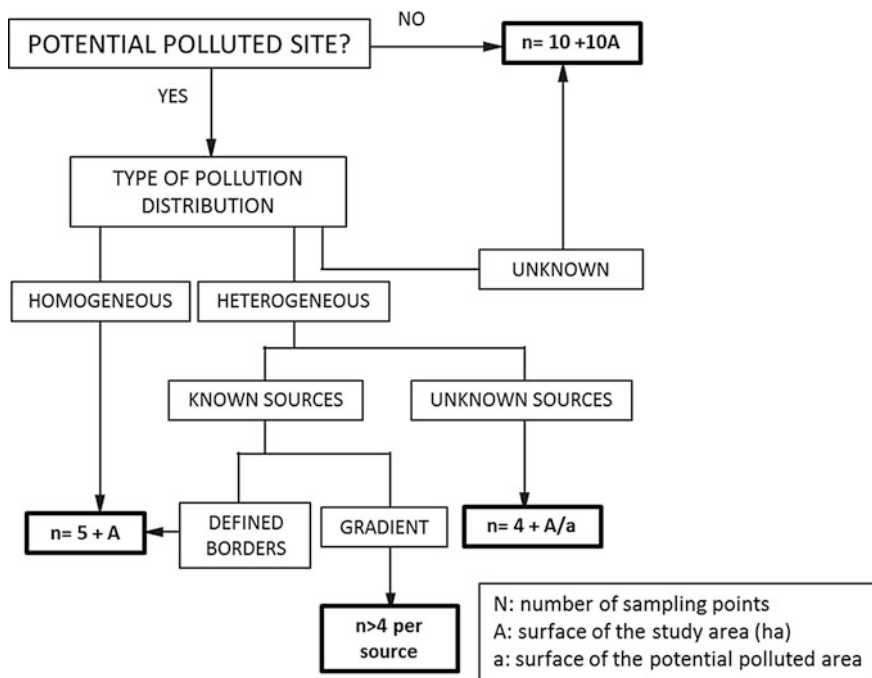
### 3.1 Study Area and Sampling Design

The study area was located in the municipality of Murcia (Region of Murcia, SE Spain), including the City of Murcia, three industrial areas (Oeste, La Polvorista and Cabezo Cortao), agricultural lands and a small part of the Regional Park of El Valle and Carrascoy, with a surface of  $10 \times 10 \text{ km}^2$ .

The study area has a semiarid Mediterranean climate, characterized by annual precipitations between 300 and 500 mm, average temperatures ranging from 14 to 18 °C, and thermal amplitudes of up to 20 °C.

In order to determine the number of samples to be collected to ensure the representativeness of the sampling, the recommendations from “Investigation of Soil Contamination. Historical Study and Design of Sampling” were used (I.H.O.B. E. 1998) (Fig. 1).





**Fig. 1** Calculation of the number of samples needed according to the study area

Figure 1 shows that the number of samples depends on the distribution type of the contamination. In this study, the distribution of the contamination was heterogeneous due to the multitude of potential metal sources, which are, in addition, unknown. Therefore, the number of samples responds to the formula:

$$n = 4 + A/a \tag{1}$$

A value in this case was 10,000 ha. In order to determine the potential area affected by metals (“a” value), it was estimated that the potential contamination should be mainly located in the industrial areas, which surface was approximately 500 ha. In addition, it was estimated that no more than 10% of this area would be contaminated (50 ha). Thus, according to Eq. (1) the total number of needed samples was 204.

In order to design the sampling grid, and following the indications reported by I. H.O.B.E. (1998), it was decided to use a regular and systematic sampling in the study area. The sampling spots were located in the vertices of consecutive squares with a separation of 1000 m in agricultural and natural lands. Since it was expected that the anthropic activities were more intense in urban and industrial areas (Imperato et al. 2003; Romić and Romić 2002), sampling separation under these latter land uses was 500 m. Thus, a total of 221 samples were collected.

Since sampling a densely populated area in quite complicated, the theoretical location of the samples according to the selected methodology (Fig. 2) was different from the actual location (Fig. 3). The depth of sampling was selected from 0 to 5 cm, because most metals are accumulated on the soil surface (Porta et al. 1999; De Miguel et al. 1998).

### 3.2 Laboratory Analysis

The samples were dried at 50 °C in a forced air oven for 48 h, homogenized and sieved at < 2. Subsequently, subsamples were ground with an agate mortar. Samples were stored in hermetically sealed plastic bags for further analysis.

The total concentration of metals (Pb, Cu, Cd, Zn, Co, Cr and Ni) was determined by sample digestion with strong acids (nitric-perchloric) at 210 °C for 90 min (Risser and Baker 1990). Metals were measured in the resulting solution by atomic absorption spectrophotometer (AAnalyst 800, Perkin Elmer).

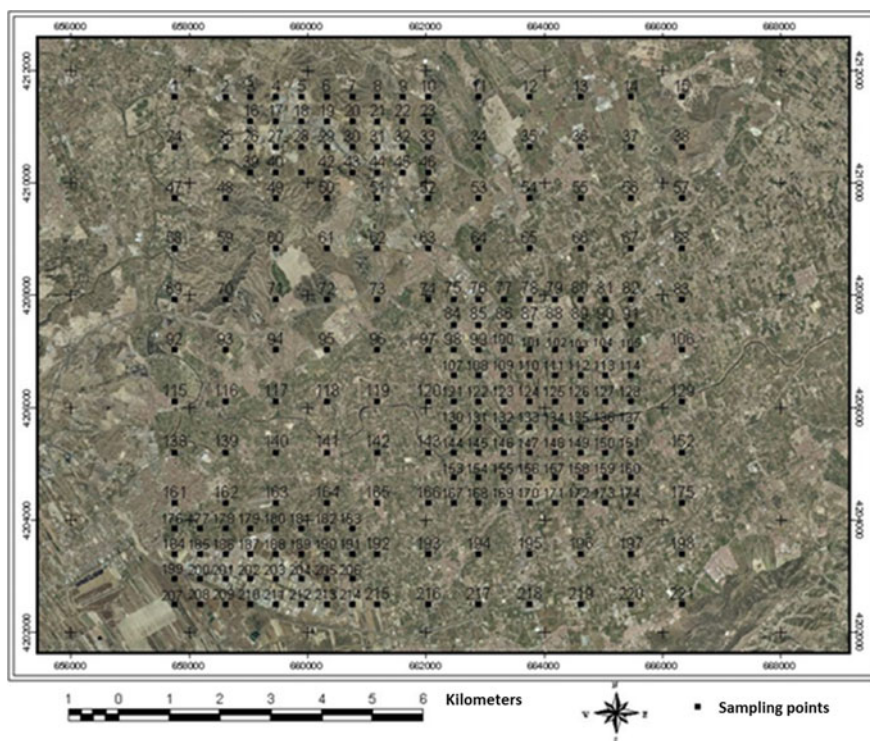
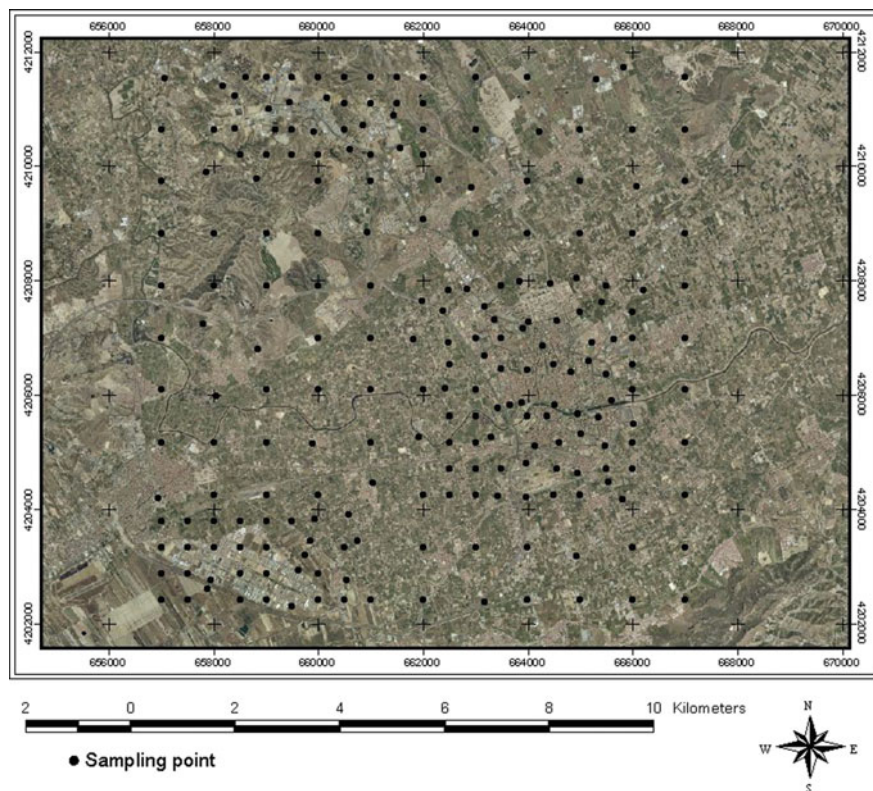


Fig. 2 Theoretical sampling map of the study area



**Fig. 3** Actual sampling map of the study area

### 3.3 Data Treatment

In order to achieve the objective of this study, the following process was followed:

- Selection of contamination indices.
- Selection of the most suitable index for the study area by carrying out the following steps:
  - Calculation of each index.
  - Statistical and geostatistical study of the data.
  - Final selection of the index using objective criteria.
- Adjustment of GIS parameters to determine the most affected areas.

## 4 Results and Discussion

Firstly, a literature review was carried out in order to identify the indices most used for the evaluation of the degree of contamination by metals in soil. The indices were selected according to the following criteria: (1) availability of the data required by the index for its calculation, and (2) the index must include all the metals analyzed in this study. With these criteria, five indices were selected; all of them included all the metals studied by means of a mathematical formula:

- MCI (metal contamination index): it is defined as the sum of the result of dividing the logarithm of the concentration of each metal ( $C_n$ ) between the logarithm of the background value ( $B_n$ ), and all divided by the number of metals used in the index (Feris et al. 2003; Ramsey et al. 2005).

$$MCI = \frac{\sum \left( \frac{\log C_n}{\log B_n} \right)}{n^{\circ}metals} \quad (2)$$

- IPI (integrated pollution index): it is defined as the sum of the result of dividing the concentration of each metal ( $C_n$ ) by its local background concentration ( $B_n$ ), and all divided by the number of metals used in the index (Ferreira da Silva et al. 2005; Chen et al. 2005).

$$IPI = \frac{\sum \left( \frac{C_n}{B_n} \right)}{n^{\circ}metals} \quad (3)$$

- MPI-2 (metal pollution index): it is defined as the n-th root of the product of each of the metal concentrations ( $C_n$ ), where “n” is the number of metals used in the index (Giusti et al. 1999; Usero et al. 1996).

$$MPI - 2 = (C_1 \times C_2 \times \dots \times C_n)^{\frac{1}{n}} \quad (4)$$

- PLI (pollution load index): it is defined as the n-th root of the product obtained by dividing the concentration of each metal ( $C_n$ ) between its background concentrations ( $B_n$ ), where “n” is the number of metals used in the index (Cabrera et al. 1999; Chan et al. 2001; Madrid et al. 2002; Cabrera et al. 2005).

$$PLI = \left( \frac{C_1}{B_1} \times \frac{C_2}{B_2} \times \dots \times \frac{C_n}{B_n} \right)^{\frac{1}{n}} \quad (5)$$

Most pollution indices include the background metal concentration as parameter; according with Chen et al. (2005), these values must be calculated from the study area. In order to reduce the possible effects of atypical values, mean concentrations were calculated with a set of robust estimators; once these were calculated, the average of all of them was the local background value used for the calculation of the indices (Table 1).

Descriptive statistics of the selected pollution indices are presented in Table 2. The different indices showed highly different values, with mean values ranging from 1.00 for MCI to 12.54 for MPI-2. Other parameters also considerably varied among indices, such as the variation coefficient, ranging from 9.76% for MCI to 336% for MPI-1. This is due to the use of logarithms in the MCI formula, grouping the values in a narrow range; in contrast, the values from MPI-1 are affected by extreme metal concentrations. IPI and MPI-1 indices present a high asymmetry of the distribution (Table 2), which is far from a normal distribution due to high kurtosis coefficients. Therefore, the indices that best represented the effect of the metals in the study area were MCI, MPI-2 and PLI, since their distribution is adjusted to a normal distribution and were not affected by extreme concentrations.

In order to know which metals more effectively contributed to the value of the indices, correlations were developed between the indices and the metal concentrations (Table 3).

The MCI index had very low correlation with lead and, especially, with cadmium, because this index uses logarithms in its formula. Although the use of logarithms reduces the effect of the extreme values, it causes a disturbance in the result of the index because the logarithm of concentrations <1 results in negative values. The logarithm of the cadmium background was negative, along with some other logarithms of concentrations <1, resulted in not significant correlations, and

**Table 1** Mean values ( $\text{mg kg}^{-1}$ ) of heavy metals concentrations using different estimators

	Huber M-estimator	Biponderate of Tukey	Hampel M-estimator	Andrews wave M-estimator	Background concentration
Chromium	17.2	16.1	16.9	16.1	16.6
Manganese	144.3	142.9	144.3	142.9	143.6
Nickel	11.5	11.6	11.6	11.6	11.6
Copper	10.4	9.6	10.1	9.6	9.9
Zinc	17.7	15.9	16.5	15.9	16.5
Cadmium	0.18	0.17	0.18	0.17	0.18
Lead	39.45	34.70	37.96	34.67	36.69

**Table 2** Descriptive statistics of selected pollution indices

	MCI	IPI	MPI-1	MPI-2	PLI
Mean	1.00	1.26	1.86	12.54	1.07
Error	0.01	0.06	0.42	0.34	0.03
Median	1.01	1.08	0.61	11.69	1.00
Standard deviation	0.09	0.89	6.25	5.18	0.44
Variance	0.01	0.80	39.17	26.85	0.19
Variation coefficient (%)	9.7	70	336	41	41
Kurtosis	0.12	50.51	50.51	0.44	0.44
Symmetry	-0.13	5.76	5.76	0.68	0.68
Range	0.59	10.09	70.68	27.81	2.38
Minimum	0.68	0.23	-5.39	2.00	0.17
Maximum	1.28	10.32	65.29	29.81	2.55

**Table 3** Correlation coefficients between the concentration of metals and the calculated indices

	MCI	IPI	MPI-1	MPI-2	PLI
Chromium	0.64*	0.25	0.25	0.56*	0.56*
Manganese	0.63*	0.19	0.19	0.52*	0.52*
Nickel	0.66*	0.19	0.19	0.50*	0.50*
Copper	0.58*	0.37	0.37	0.63*	0.63*
Zinc	0.55*	0.61*	0.61*	0.69*	0.69*
Cadmium	-0.03	0.57*	0.57*	0.53*	0.53*
Lead	0.14	0.88*	0.88*	0.43	0.43

\*p &lt; 0.001

in the end, the final result of the index does not respond to the real pattern for this element.

Oppositely, there were high correlation coefficients between lead concentrations and IPI and MPI-1 indices. This indicates a high influence of this element on the result of the index, suggesting that these indices do not adequately represent the totality of the studied metals. In contrast, MPI-2 and PLI indices showed the most homogeneous correlations, all of them ranging from 0.4 to 0.7. They seemed to represent the effect of all metals in a more realistic way with the purpose of the identification and final delimitation of the most affected areas.

The spatial distribution of each index is presented in Fig. 4. IPI and MPI-1 indices, and MPI-2 and PLI indices, showed, respectively, the same distribution pattern, with no other difference than the data range. In contrast, MCI index showed a different distribution pattern.

The spatial distribution of the MCI index was confusing because the logarithmic scale grouped all the concentrations in a narrow range, making difficult a good view of the most affected areas. In addition, this index does not have a reference scale for indicating the degree of contamination (Caeiro et al. 2005), and then it is not possible to know when an area is scarcely, moderately or highly affected.

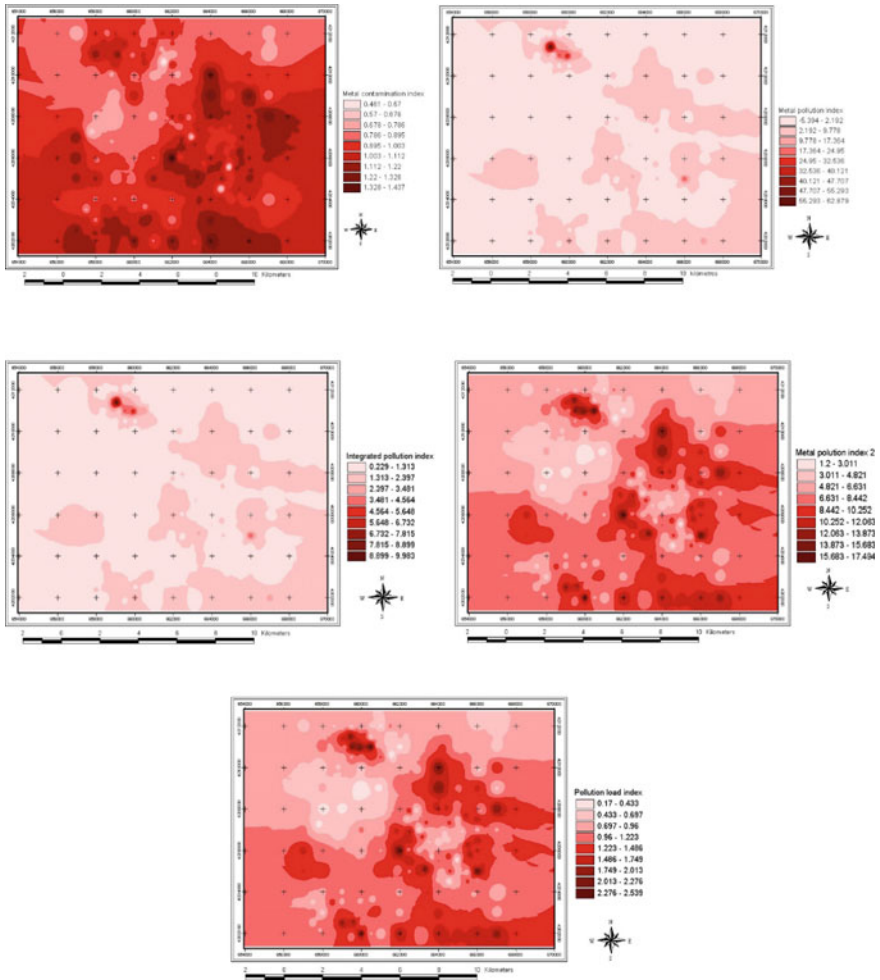


Fig. 4 Spatial distribution of the selected indices

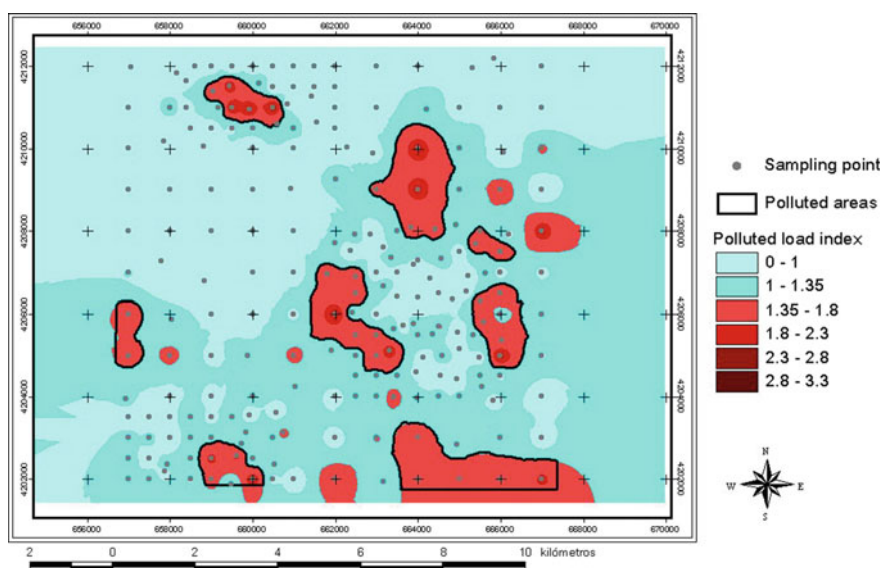
Therefore, this index was discarded for three main reasons: (1) effect of logarithm on the result of the index for concentrations below one, (2) low representation of cadmium and lead, and (3) unclear spatial distribution because of logarithmic scale.

The spatial distribution of IPI and MPI-1 indices was strongly affected by extreme concentrations, in particular by lead concentrations located in the industrial area Polvorista-Cabezo Cortao, northwest (Fig. 3). In addition, the coefficients of variation of these indices (Table 2) and their high correlation with lead (Table 3) indicated that these indices do not represent the actual pollution of the study area. As a consequence, both indices were discarded.

Finally, the MPI-2 and PLI indices provided a good overview of the areas affected by the set of metals (Fig. 3). In addition, the contribution of each metal to

the final results of were similar; and the data showed a distribution close to normality, so they were not affected by extreme values. The only difference between these two indices is that MPI-2 does not use background concentrations in its calculation, without a reference scale that indicates the degree of pollution. In contrast, the PLI index represents the number of times the concentration of the metals exceeds the background concentration, giving an overall indication of the toxicity of the metals in each particular sample (Chan et al. 2001). Therefore, PLI values lower than one would indicate concentrations of metals near the bottom value, while values above one would indicate contamination (Cabrera et al. 1999). Therefore, the PLI index was selected for the identification of the most affected areas.

In order to delineate homogeneous and independent affected areas, up to 35% higher than one was selected to consider a polluted area (Caeiro et al. 2005), and the results were represented on a spatial distribution map (Fig. 5). Eight affected areas were identified and delimited, where further and deeper studies should be carried out. Note that isolated points with values higher than 1.35 were discarded because a single spot does not have enough entity to delimit a polluted area.



**Fig. 5** Spatial distribution of the Polluted Load Index with delimitation of the areas affected by metal pollution



## 5 Conclusions

Results indicated that the Pollution load index (PLI) was the best index for delimitating the areas most highly affected by metal pollution, with eight areas identified in this study. These areas should be studied in detail in order to assess environmental hazards. Therefore, the combined use of contamination indices and GIS is an appropriate tool for the rapid identification of environmental risk areas, although they should be evaluated for each particular case.

## References

- Abollino O, Aceto M, Malandrino M, Mentaste E, Sarzanini C, Barberis R (2002) Distribution and mobility of heavy metals in contaminated sites. Chemometric investigation of pollutant profiles. *Environ Pollut* 119:177–193
- Ahmed F, Ishiga H (2006) Trace metal concentrations in street dusts of Dhaka city, Bangladesh. *Atmos Environ* 40:3835–3844
- Cabrera F, Clemente L, Díaz Barrientos E, López R, Murillo JM (1999) Heavy metal pollution of soil affected by the Guadiamar toxic flood. *Sci Total Environ* 242:117–129
- Cabrera F, Medejón E, Burgos P, Girón I, Murillo JM (2005) Elementos traza en suelos y plantas del estero domingo rubio (margen izquierda del Río Tinto, Huelva). In: Jiménez R and Álvarez A.M., Control de la degradación de suelos. Univ. Autónoma de Madrid, Madrid, Spain
- Caeiro S, Costa MH, Ramos TB, Fernandes F, Silveira N, Coimbra MP (2005) Assessing heavy metal contamination in Sado Estuary sediment: and index análisis approach. *Ecol Indic* 5:151–169
- Chan LS, Davis AM, Yim WWS, Yeung CH (2001) Magnetic properties and heavy metal contents of contaminated seabed sediments of Penny's bay, Hong Kong. *Mar Pollut Bull* 42:569–583
- Chen T, Yuan-Ming Z, Mei L, Ze-Chun H, Hong-Tao W, Huang C, Ke-Ke F, Ke Y, Xiao W, Qin-Zheng T (2005) Assessment of heavy metal pollution in surface soils of urban parks in Beijing, China. *Chemosphere* 10:154–164
- Chronopoulos J, Maidouti C, Chronopoulos-Sereli A, Massas I (1997) Variations in plant and soil lead and cadmium content in urban park in Athens, Greece. *Sci Total Environ* 196:91–98
- Conesa HM, Moradia AB, Robinson BH, Kühneb G, Lehmann E, Schulin R (2009) Response of native grasses and *Cicer arietinum* to soil polluted with mining wastes: implications for the management of land adjacent to mine sites. *Environ Exp Bot* 65:198–204
- Conesa HM, Robinson BH, Schulin R, Nowack B (2007) Growth of *Lygeum spartum* in acid mine tailings: response of plants developed from seedlings, rhizomes and at field conditions. *Environ Pollut* 145:700–707
- De Miguel E, Jiménez de Grado J, Llamas JF, Martín-Dorado A, Mazadiago LF (1998) The overlooked contribution of compost application of the trace element load in the urban soil of Madrid (Spain). *Sci Total Environ* 215:113–122
- Ferguson C, Kasamas H (1999) Risk assessment for contaminated sites in Europe, vol 2. Policy Framework, LQM Press Ed., Nottingham
- Feris K, Ramsey P, Frazar C, Moore J, Gannon J, Holben W (2003) Differences in hyporheic-zone microbial community structure along a heavy metal contamination gradient. *Appl Environ Microb* 69:5563–5573
- Ferreira da Silva E, Cardoso E, Matos J, Patiha C, Reis P, Santos J (2005) The effect of unconfined mine mailing on the geochemistry of soils, sediments and surface water of the Lousal area (Iberian pyrite belt, Southern Portugal). *Land Degrad Dev* 16:213–228

- Ferreira-Baptista L, De Miguel E (2005) Geochemistry and risk assessment of street dust in Luanda, Angola: a tropical urban environment. *Atmos Environ* 38:4501–4512
- Gäblere HE, Sschneider J (2000) Assessment of heavy metal contamination of floodplain soils due to mining and mineral processing in the Harz Mountains, Germany. *Environ Geol* 39(7): 774–782
- Giusti L, Williamson AC, Mistry A (1999) Biologically available trace metals in *Mytilus Edulis* from the coast of Northeast England. *Environ Int* 25:969–981
- Govil PK, Reddy GLN, Krishna AK (2001) Contamination of soil to heavy metals in the Patancheru industrial development area, Andhra Pradesh, India. *Environ Geol* 41:461–469
- I.H.O.B.E. (1998) Investigación de la Contaminación del Suelo, Estudio Histórico y Diseño de Muestreo. Bilbao
- Imperato M, Adamo P, Naimo D, Arienzo M, stanzione D, Violante P (2003) Spacial distribution of heavy metals in urban soils of Naples City (Italy). *Environ Pollut* 124:247–256
- Madrid L, Díaz-Barrientos E, Madrid F (2002) Distribution of heavy metal contents of urban soils in parks of Seville. *Chemosphere* 49:1301–1308
- Navas A, Lindhorfer H (2003) Geochemical speciation of heavy metals in semiarid soils of the Central Ebro Valley (Spain). *Environ Int* 29:61–68
- Ottenhof C, Faz A, Arocena J, Nierop K, Verstraten J, van Mourik J (2007) Soil organic matter from pioneer species and its implications to phytostabilization of mined sites in the Sierra de Cartagena (Spain). *Chemosphere* 69:1341–1350
- Porta J, López M, Roquero C (1999) Edafología para la agricultura y el medio ambiente, 2º edn. Mundi Prensa, Madrid
- Ramos TB, Caeiro S, Melo JJ (2002) Environmental indicator frameworks to design and assess environmental monitoring programs. *Impact Assess. Project Appraisal J* 22:46–62
- Ramsey PW, Rilling MC, Feris KP, Moore JN, Gannon JE (2005) Mine waste contamination limits soil respiration rates: a case study using quantile regression. *Soil Biol Biochem* 37:1177–1183
- Risser JA, Baker DE (1990) Testing soils for toxic metals. In Westerman RL (ed) *Soil Testing and plant analysis*. Soil Sci Soc Am Spec Publ 3. 3rd ed, Madison
- Romic M, Romic D (2002) Heavy metals distribution in agricultural topsoils in urban area. *Environ Geol* 43:795–805
- Salviaggio D, Angelone M, Bellanca A, Neri R, Sprovieri M (2002) Heavy Metals in urban soils: a case study in the city of Palermo (Sicily), Italia. *Sci Total Environ* 300:229–243
- Usero J, González-Regalado E, Gracia I (1996) Trace metals in bivalve mollusc *Chamelea gallina* from the Atlantic coast of Southern Spain. *Mar Pollut Bull* 32:305–310
- Zanuzzi A, Arocena JM, van Mourik JM, Faz A (2009) Amendments with organic and industrial wastes stimulate soil formation in mine tailings as revealed by micromorphology. *Geoderma* 154:69–75

**Part V**  
**Energy Efficiency and Renewable Energies**

# Review of Numerical Models for Studying the Dynamic Response of Deep Foundations for the Design and Project of Wind Turbines



G. M. Álamo, J. D. R. Bordón, F. García, J. J. Aznárez, L. A. Padrón, F. Chirino and O. Maeso

**Abstract** Wind turbines support structures must be designed so that the natural frequencies of the entire system are sufficiently separated from the frequency of the different dynamic loads acting on the wind turbine. The design and analysis of the soil-foundation subsystem is subject to significant levels of uncertainty and simplification. Besides, as the number of wind farms increases, so does the need for installing wind turbines in weaker soils, which leads to the use of deeper foundations such as piles and suction caissons. Thus, the need exists for developing computational models able to estimate, with increasing accuracy and efficiency, the dynamic properties of the foundations mentioned above with the aim of being able to reach optimized, safe and long-life designs that help improving the profitability of the technology and reducing the wind energy costs. In this line, this paper presents a review of computational models, with different degrees of accuracy, applicable to the analysis of the dynamic response of deep foundations for onshore and offshore wind turbines.

**Keywords** Wind turbines · Soil-structure interaction · Boundary element method Structural dynamics

## 1 Introduction

The installed capacity of electricity generation from offshore wind power has been growing exponentially in the last few years. So much so, that the production capacity connected to the grid in Europe grew in 2015, nothing less than 108% more than in 2014. Specifically, 3019 MW of power were added through the

---

G. M. Álamo · J. D. R. Bordón · F. García · J. J. Aznárez · L. A. Padrón (✉) · F. Chirino O. Maeso

Instituto Universitario de Sistemas Inteligentes y Aplicaciones Numéricas en Ingeniería (SIANI), Universidad de Las Palmas de Gran Canaria, Edificio Central del Parque Científico y Tecnológico, Campus Universitario de Tafira, 35017 Las Palmas de Gran Canaria, Spain  
e-mail: luis.padron@ulpgc.es

installation of new offshore wind turbines in 15 different farms, connected to the European electric network. For that matter, it is really shocking that, of the 3,230 offshore wind turbines installed in Europe until December 31st 2015, only one is installed in Spain (a 0.03% of the total). Moreover, at the moment, there are 6 projects underway in Germany, the Netherlands and United Kingdom, which will contribute close to 2000 MW more to a growth that is expected to continue in the near future (EWEA 2016).

Almost all offshore wind turbines installed in Europe are located in places where the depth of the sea allows founding them directly to the seabed (compared to the alternative of floating wind turbines, which is still anecdotic for the time being). In fact, the average water depth in wind farms installed or under construction during 2015 was 27.1 m, with an average distance to the coast of 43.3 km. Nonetheless, there are operating farms in depths up to 50 m and located at a distance up to 120 km from the nearest coast. Thus, in Europe, and until December 31st 2015, 80% of wind turbines are installed over monopiles, 9.1% over shallow foundations and the rest over structures with several supports, as groups of three suction caissons (3.6%) or three piles (1.7%) (EWEA 2016).

With the above mentioned growth of the offshore wind farms' number, the need arises to install the wind turbines at greater depths and/or in soils with worse load-bearing characteristics. Given the special characteristics of the loads generated on the foundation by the offshore wind turbines (large bending moments applied to the seabed with significant horizontal loads but very low vertical load), the use of shallow foundations is only feasible in some cases (limited depths and/or rock bed of a very good load-bearing capacity). For the remaining cases, as it is highlighted in the previous paragraph, it is necessary to use deep foundations, mainly piles. Suction caissons, on their part, although still small in number, offer important potential benefits: lower installation costs, lower costs for geotechnical exploration due to their lesser embedding depth, and the possibility of uninstalling the foundation. For these reasons, the analysis and development of this alternative is producing a growing interest. These two foundation types (piles and suction caissons) are the study object of this communication.

In this respect, it is important to take into account that the cost associated with the foundation, represents, in general, a very important proportion of the total required investment for offshore wind farms implementation. Specifically, the design, construction and installation of, for example, the monopile for an offshore wind turbine represents about 15–20% of the total initial cost. In some projects, this cost can be as high as 25–30% (Byrne and Houlsby 2003; Musial and Ram 2010; Bhattacharya 2014). It has also been estimated that foundation costs are estimated to increase approximately linearly with depth (Musial and Ram 2010). It becomes clear then that the reduction of the implementation costs of these foundations by improving the proposed solutions during the project's first phases would represent an important factor when favoring the implementation of new offshore wind farms, and would also improve the profitability of this technology by reducing its initial costs and, at the same time, increasing its useful life.

It is important to take into account that, contrary to what happens in many other types of projects, the final design and dimensioning of offshore wind turbines foundations are not totally conditioned by the requirements associated with Ultimate Limit States, but for those of the Fatigue Limit State (accumulation of damage due to repetitive loads) and Serviceability Limit States, because compliance with these last two states is very restrictive (Arany et al. 2015) and often implies a loose compliance of the Ultimate Limit States requirements. Among these Ultimate Limit States, is the structural failure of the substructure itself or the surrounding soil (load-bearing capacity loss), or the overturning or sliding stability loss. The Serviceability Limit States include excessive deflection or rotation at the foundation head or at the nacelle, permanent rotations, excessive settling, differential settling or excessive vibrations (DNV 2014).

A vital importance is granted to the detailed analysis of the Fatigue Limit State, because it is directly related both with the planned useful life for the wind turbine as a whole, and with the possibility of extending the operational life (thus, increasing the facility profitability). The foundation dynamic characteristics, in terms of rigidity and capacity to dissipate energy (damping), play a fundamental role in the reduction of the accumulated damage, because both of them are key to reducing structure vibration amplitude. In the rigidity case, its proper estimation in the project's design and planning phases allows preventing the structure from vibrating in resonance with any of the multiple dynamic loads to which it is subjected (waves, currents, winds, blades passing in front of the shaft, rotor and blades imbalances...). In the damping case, higher values of this parameter in the foundation allow maximizing the mechanical energy evacuation from the structure through the ground.

Still, it is the compliance of requirements associated with Serviceability Limit States that generally determines the foundation's final design and dimensioning. For example, in the case of a monopile, the criterion for maximum rotation at pile head can be associated with an oversizing higher than 15% in diameter, with regard to the majority of the remaining criteria (Arany et al. 2015). Another criterion related with this can lead to more important oversizing, for instance, the achievement of a given rigidity, guarantying that the system's natural frequencies remain sufficiently far from the loads' characteristic frequencies. For this reason, and as it has been numerically observed (Damgaard et al. 2014a) deformation and tension levels achieved in the ground (and of course, in the foundation itself) tend to be lower than the yield point, so the foundation is operating fundamentally in the elastic and linear range. This justifies that many of the proposed models that are later used are of the linear-elastic type.

These low deformation levels will also favor a certain stability over time of the foundation performance in terms of dynamic rigidity and damping. This way, the global system natural frequencies do not deviate from the established ones. As it was mentioned, this aspect is especially relevant with regard to the need that the natural frequencies are maintained sufficiently away from the frequencies defining excitations. Still, with the accumulation of load cycles, a certain degradation of the dynamic properties of the turbine could occur. Several researchers are occupied in

finding out whether this aspect could influence negatively and significantly the structure response in the long term (Foglia et al. 2015; Bhattacharya et al. 2012, 2013; Cox et al. 2014). For this end, the main tool is the elaboration and test of scale empirical models, such as the proposed by Bhattacharya et al. (2012) and Bhattacharya et al. (2013) over a model 1:100 and 1-g of a wind turbine over monopiles or a group of three or four suction caissons; where degradation, compaction and stiffening phenomena of the surrounding soil are observed, leading to significant changes in the foundation properties. Subsequently, Cox et al. (2014), when performing a centrifugal study of individual suction caissons behavior, found similar tendencies in this foundation types, but more limited than in the monopiles case. In any case, these degradation phenomena, if they are produced, occur slowly and progressively in the long term, so the study on the system's response at a given moment is made through models that do not necessarily consider these phenomena.

Thus, to analyze the dynamic response of deep foundations for wind turbines, several different models. The numeric modeling of the dynamic response of deep foundations for wind turbines is important because the interaction between the support structure and the soil modifies the dynamic response of the structure as a whole. For this reason, the structure cannot be studied as perfectly fixed to the soil. These soil-foundation-structure interaction phenomena are much more important in offshore wind turbines than in the onshore ones, not only because of the seabed nature, the wider variety of dynamic loads that the structure withstands and the higher magnitude of these loads, but also due to the larger height of the support structure (which has an aerial plus a submerged section that can frequently be longer than 30 m). This higher height increases the influence of the inertia forces over the foundation and produces a higher flexibility of the structural group.

For these reasons, this communication describes in the first place, the diversity of existing models for the estimation of the foundation dynamic response, so the phenomena soil-foundation-wind turbine can be evaluated (Sect. 3). Subsequently, in Sect. 4, a group of advanced numeric models is presented, each one with their particularities and application cases, proposed and developed by the authors of this communication, for the dynamic response analysis of deep foundations for wind turbines. Their utilization is shown in Sect. 5 with a selection of results.

## 2 Objectives

The objective of this communication is to present a state of the art review regarding the dynamic modelling of foundations for wind turbines and subsequently to describe different advanced computational models, related mainly to the Boundary Element Method (specially indicated for the study of not bounded media such as the soil). These models allow analyzing the dynamic response of deep foundations for wind turbines and, thus, studying soil-foundation-wind turbine interaction phenomena. This is done with the intention of contributing to obtain optimal support

structures designs, secure and with a larger useful life, and as a consequence, to improve this technology's profitability and to reduce costs.

### **3 Review of Commonly Used Numerical Models for the Study of the Dynamic Response of Deep Foundations for Wind Turbines**

In scientific and technical literature, a significant number of models are commonly used to study the dynamic response of deep foundations for wind turbines. In the first place, the two approximations with a higher level of simplifications are: (a) the rigid base model (in which soil-structure interaction is directly disregarded), and (b) the model of apparent (or effective) fixation length, which consists in considering that the wind turbine tower is longer than it actually is, adjusting this added length such that the lost flexibility due to the presence of a flexible foundation in an also flexible soil will be partially incorporated (Zaaijer 2006). However, due to their excessive simplicity, these models are no longer used when the interest lies in considering the effects of the soil-structure interaction. Thus, the most used models for the study and analysis of the structural response of deep foundations for wind turbines including the soil-structure interaction effect, can be classified in the following four groups.

#### ***3.1 Stiffness Matrix Models***

The models based on the stiffness matrix at mudline are those in which the interaction with the soil-structure system is modeled through actions equivalent to one or several punctual linear springs and dashpots (generally, viscous) in the tower base at the foundation terrain height. In some cases, such elements consider only stiffness and damping to rotation. In the most complete models not only rotation and horizontal interactions are included, but also their cross influences, which are significant in deep foundations. For that matter, Zaaijer (2006) is the reference work regarding the application of these concepts to the case of offshore wind turbines, comparing this model with the more simple ones above described, and with the model exposed in the next point. He arrives to the conclusion that the complete stiffness matrix model defined at the foundation bed depth is the best approximation for the case of monopiles.

On the other hand, more simple models consider static coefficients, while the more complete models include their dynamic characteristics, even with concentrated parameters models (Lumped Parameter Models). These models allow the use of frequency-dependent stiffness and damping coefficients in analyses performed in the time domain (for example, see Damgaard et al. 2014a).



In any case, the key aspect in the model utilization is, of course, obtaining and/or defining the necessary stiffness and damping functions. They can be taken from expressions found in the literature, generally for the static case (Poulos and Davis 1980; Randolph 1981; Gazetas 1984 or Eurocode 8 – Part 5, 2003) or they can be derived from the direct application of the methodologies described in the following sections.

### 3.2 *Winkler-Type Models for Monopiles*

Models of distributive rigidity of the Winkler type, are those in which the pile is generally modeled as a monodimensional, linear and elastic beam subjected to bending, while its interaction with the soil is represented through a series of springs and dashpots distributed along the depth.

A first subgroup of this case comprises elastic and linear models in which the key aspect is to obtain the expression that defines the interaction between pile and soil. These models are widely used in different fields of structure dynamics (Novak et al. 1978; Kavvadas and Gazetas 1993; Mylonakis 2001; Dezi et al. 2009).

Another subgroup is that in which the properties of the distributed springs and dashpots depend, not only on the pile and the soil in each case, but also on the depth, the deformations magnitude and the previous states, so it is non-linear in nature. The most used behavior laws in this case are the ones called  $p$ - $y$ ,  $t$ - $z$ ,  $Q$ - $z$ . They relate horizontal and vertical loads and deflections, acting along shaft and pile tip, respectively. The  $p$ - $y$  curve, for instance, represents the soil's horizontal resistance ( $p$ ) per unit length of the pile when it undergoes a lateral displacement ( $y$ ) against the soil. These  $p$ - $y$  type models are probably the more extended and commonly used, among other reasons because they appear in Sect. 10.1.5 (soil-structure interaction) of the design standard for offshore wind turbine structures (DNV 2014) as an example of a possible model to be used in the dynamic analysis of the wind turbine. However, more and more specialists insist that this model is not appropriate for the specific problem here analyzed, mainly because the  $p$ - $y$  curves were obtained for diameters and load conditions very different to those found in the wind turbines case, and also because they do not adequately consider the inertial effects involved, among other reasons. In fact, appendix F (Sect. 2.4) of the above mentioned standard (DNV 2014) includes a series of notes mentioning the precautions with which this type of models should be used, due to several possible problems associated with their use in different situations.

Specific examples of the use of this methodology in the field of dynamic response of wind turbines are the works of Jonkman et al. (2008) and Abhinav and Saha (2015). Another example is the work of Damgaard et al. (2014b) in which the influence of pore pressure in the saturated seabed is also researched, justifying the need for model development which considers the terrain's porous nature and the different possible water saturation states, as is the case of one of the models described in Sect. 4.

### 3.3 *Advanced BEM-FEM Coupled Models*

The Boundary Elements (BEM) and Finite Elements (FEM) coupled models allow modelling more rigorously the geometries and characteristics of the foundation and soil, even though these analyses are basically performed in a linear-elastic regime, as it was stated in this document's introduction. They also allow considering the real foundation geometry and all their elements simultaneously. This is also true in the case of foundations formed by pile groups or suction caissons, also directly including the superstructure if necessary. An application of this methodology to the study of the dynamic response of foundation caissons is the work of Liingaard et al. (2007), while in the field of piled foundations, examples of works in this line are those of Kaynia and Kausel (1991), Maeso et al. (2005) or Padrón et al. (2007).

### 3.4 *Advanced Non-linear Finite Element Models*

When it is necessary to include nonlinear behaviors in three dimensional foundation models, it is generally required to use models based on the Finite Element Method. In these cases, the nonlinear phenomena are usually centered in the soil behavior and the soil-foundation contact (slippage, separation...), although in some cases the structural element can also develop nonlinear behaviors, as in the case of buckling (Madsen et al. 2015). Except in this last case, the justification for the use of these complex and costly models is not still clear, as it was argued in the introduction. In these cases, the first step (and the main obstacle) is the selection of the material behavior law (generally the soil) and all the parameters that these models include and which are not always easily estimated.

An interesting example of this model use is found in the work of Jung et al. (2015), who use a three dimensional and nonlinear model of Finite Elements to model the dynamic response of an offshore wind turbine monopile. They incorporate the failure criteria of sand or clay soils, according to the Mohr-Coulomb and Tresca models respectively and validate it with previous experimental results. The authors compare the results of this model with the results of a Winkler type model, based on the  $p$ - $\gamma$  curves, and with those of a model which does not consider foundation flexibility. They show that this last model is too simple and produces erroneous results and, for example, underestimates moments at the structure base. At the same time, they show that the nonlinear FEM model produces larger rotations at the pile tip, but that the Winkler and MEF models offer very similar results regarding natural frequencies and maximum stresses. This supports the idea that this type of advanced models is only justified for very specific calculations or cases. Some of them can be seen in the works of Anastasopoulos and Theofilou (2016) and Carswell et al. (2015) for piles, or Jin et al. (2014) for groups of suction caissons.

## **4 BEM-Based Advanced Numerical Models for the Analysis of the Dynamic Response of Deep Foundations for Wind Turbines**

The previous section showed the range of methodologies available for modelling the dynamic response of deep foundations for wind turbines. As seen above, it is still necessary to make progress in the development of methods and advanced and rigorous numerical models. These methods and models have to be capable of taking into account the real geometry and properties of all involved elements, and also of estimating the actual system response characteristics. Moreover, these models have to be computationally efficient to make their use feasible in the different project phases. This computational efficiency also has to support the study of the vast amount of different load cases that need to be analyzed during the design and verification of the wind turbine structure (Zaaijer 2006; DNV 2014).

For this end, as it has been previously argued, linear and elastic models seem to be the best option to study all eminently linear aspects of the analysis (study of frequencies and eigenmodes, study of the system response in nominal regime of operation, etc.). For these cases, this section presents several models developed by the authors of this document, which are optimal for their application in different situations.

### ***4.1 Multidomain Boundary Elements Model for the Analysis of Problems Involving Poroelastic Regions***

Historically, this was the first model developed by the group to address the dynamic impedances calculation of piles and pile groups in saturated soils (Maeso et al. 2005). Additionally to being able to model the soil as an elastic medium, it allows the analysis of a particular case of water saturated or quasi-saturated soils by considering them as pore-elastic media, according to Biot's theory (Biot 1956, 1962). In these soils, that can be characteristic of the seabed, the interaction phenomena between soil and structure are of a special importance.

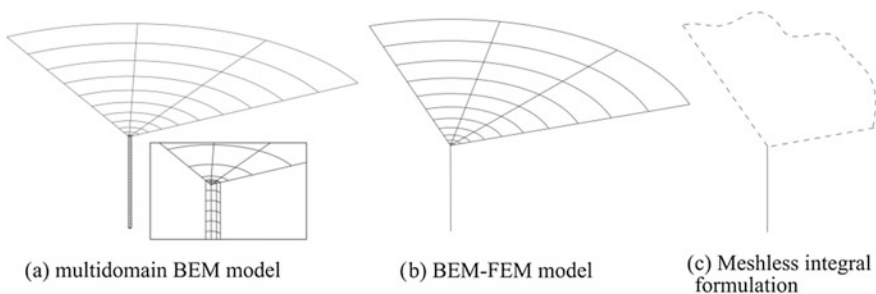
In the case of water saturated or quasi-saturated soils, the problem is addressed three dimensionally, considering the piles as a viscoelastic continuous medium and the surrounding soil as a pore-elastic medium, taking into account its two-phase nature. The BEM equations are applied to each one of the regions, performing the coupling through the equilibrium and compatibility conditions along the pile-soil interface.

The model presents some not negligible advantages: it allows to reproduce any foundation geometry, including different piles or inclined piles with their real cross section; it is possible to model the contact condition between pile and soil, being it

permeable or impermeable; it is possible to include subsoil geometries with layers with different characteristics (elastic or poroelastic), or it is even possible to take into account the presence of a water layer over the foundation soil, as it occurs in the offshore wind turbines installation. As the principal disadvantage, it must be mentioned that a great computational effort is required, but it is compensated with a higher versatility, generality and precision.

#### ***4.2 Finite Elements—Boundary Elements Coupled Model for the Analysis of the Dynamic Response of Piles and Pile Groups***

In the search for a way to reduce the great number of degrees of freedom necessary to use models based on BEM (see Fig. 1), the authors have developed a BEM-FEM coupled model for the dynamic study of pile foundations in the frequency domain (Padrón et al. 2007). The soil is modeled through BEM, taking advantage of this formulation possibilities to represent semi-infinite spaces, as one (or several) homogeneous, isotropic, viscoelastic and linear domains; while the piles are represented using FEM as Bernoulli beams, disregarding their torsional stiffness. It is assumed that soil continuity is not altered by the piles presence, but they are treated as monodimensional load lines acting in its interior. This way, the discretization of the soil-pile interface is not necessary, and the only variables left associated with the piles are the displacements and rotations of the pile section and the distributed tractions of soil-pile interaction. Despite these simplifications, the BEM-FEM model reaches results which are equivalent to those from a complete formulation based on BEM, such as the one presented in the previous section. Thus, the BEM-FEM model is a tool that can be used to obtain dynamic responses for piled foundations in homogeneous terrains or in soils with irregular stratigraphy. Nonetheless, if the number of layers is very high, the BEM-FEM coupled model, as well as a BEM multidomain model, implies a high computational cost, due to the necessity to discretize each one of the boundaries that constitute the interfaces, with the subsequent increase on the degrees of freedom and size of the model matrices.



**Fig. 1** Comparison between BEM multidomain, BEM-FEM and integral models

### ***4.3 Meshless Integral Model for the Analysis of the Dynamic Response of Piles and Pile Groups***

To avoid this inconvenience and be able to assess problems with more realistic soil profiles, in the last few years the authors have developed an integral model (Álamo et al. 2016) where the fundamental solution of the infinite elastic domain used in the previous BEM-FEM model is substituted by a fundamental solution for the stratified half-space (Pak and Guzina 2002). By using this fundamental solution, which already verifies the free surface condition, as well as the compatibility and equilibrium between the layers, the discretization of the terrain boundaries is avoided. Thus, the problem's degrees of freedom are reduced only to the ones pertaining to the piles (displacements, rotations and soil-pile interaction tractions). For this reason, this model is ideal to study terrains with several horizontal layers, or those which properties vary continuously with depth, through approximation by a sufficient number of layers.

As has been mentioned, both models can be used to obtain impedance functions of foundations constituted by one or more piles, and also to directly analyze the wind turbine-foundation system as a whole. To do this, it is only necessary to attach a finite element model of the shaft to the upper part of the foundation.

### ***4.4 Finite Elements—Boundary Elements Coupled Model for the Analysis of the Dynamic Response of Suction Caissons***

A suction caisson is a buried laminar structure, cylindrical in shape, which is geometrically defined by its diameter  $D$ , length  $L$  and thickness  $t$ . The metallic sheet has a thickness  $t$  which is much smaller than any of the other characteristic dimensions of the caisson, that is,  $t \ll L, D$ .

For the study of this type of foundations, BEM-BEM multidomain models can be used, such as the one mentioned earlier. However, their use has important disadvantages of numerical, computational and methodological nature. On the one hand, the presence of a domain (the skirt) of a small thickness creates difficulties in the numerical calculation of the necessary integrals to construct the BEM equation system. Furthermore, the linear equation system's matrix is very bad conditioned due to the closeness of the points in which the integral equations are situated, at both sides of the sheet. These two factors combined lead to numerical errors very difficult to resolve. On the other hand, due to the laminar nature of the structure, the Kirchoff (thin sheet) or Reissner-Mindlin (thick sheet) hypotheses are perfectly suitable and lead to a reduction of the degrees of freedom with respect to a continuous model, which reduces computational costs associated to the equation system resolution. Finally, the mesh construction, as well as the calculation of the

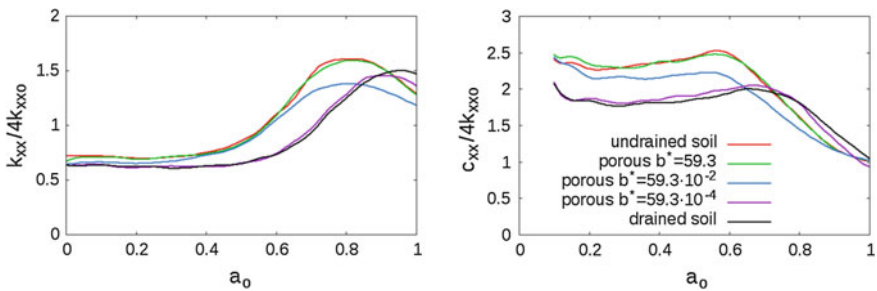
caisson variables of interest, e.g., stresses, requires an important pre- and post-processing time investment.

For the reasons stated in the previous paragraph, the authors have developed a BEM-FEM model (Bordón et al. 2016) for buried laminar structures, where discretization is completely direct and natural. The laminar structure in this case, the suction caisson, is discretized through sheet type finite elements, and its interaction with the surrounding soil is treated with crack type boundary elements. In this case, unlike in the Liingaard et al. model (Liingaard 2007), the use of artificial inter-phases is not necessary. This model is being used for impedance calculation of elastic and poroelastic soils, but the direct study is also possible, by incorporating the superstructure to the model.

### 5 Results

In this section, a selection of results obtained by the authors of this communication are presented, which show in a very succinct manner some of the possibilities of the codes developed by the research group and mentioned in the previous section.

In the first place, Fig. 2 shows the influence of the soil poroelastic properties over the dynamic response of a piled foundation obtained with the multidomain boundary elements code (Maeso et al. 2005) described in Sect. 4.1. Specifically, it shows the horizontal impedance functions (dynamic stiffness and damping of the foundation) of a square group of 4 piles of diameter  $d$ , length  $L$  and separation between centers  $s$ , with geometrical ratios  $s/d = 5$  y  $L/d = 15$ . With regard to the mechanical properties of soil and pile, the presented results have been calculated for a poroelastic soil with a porosity  $\Phi = 0.35$ , solid skeleton damping factor  $\beta = 0.05$ , a reinforced concrete pile, a relation between the pile Young modulus and the soil drained Young modulus  $E_p/E = 343$ , a relation between pile and soil densities  $\rho_p/\rho = 1.94$ , a Poisson coefficient in the pile of 0.2 and dissipation constants  $b^* = 59.3, 0.593$  or  $0.00593$ . Additionally, the null or infinite values corresponding to the ideal cases of perfectly drained soils or undrained soils are considered (see

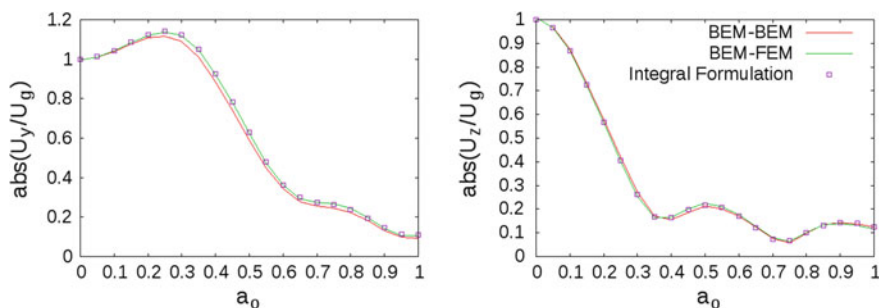


**Fig. 2** Horizontal impedances of  $2 \times 2$  pile groups in poroelastic soils with different permeabilities

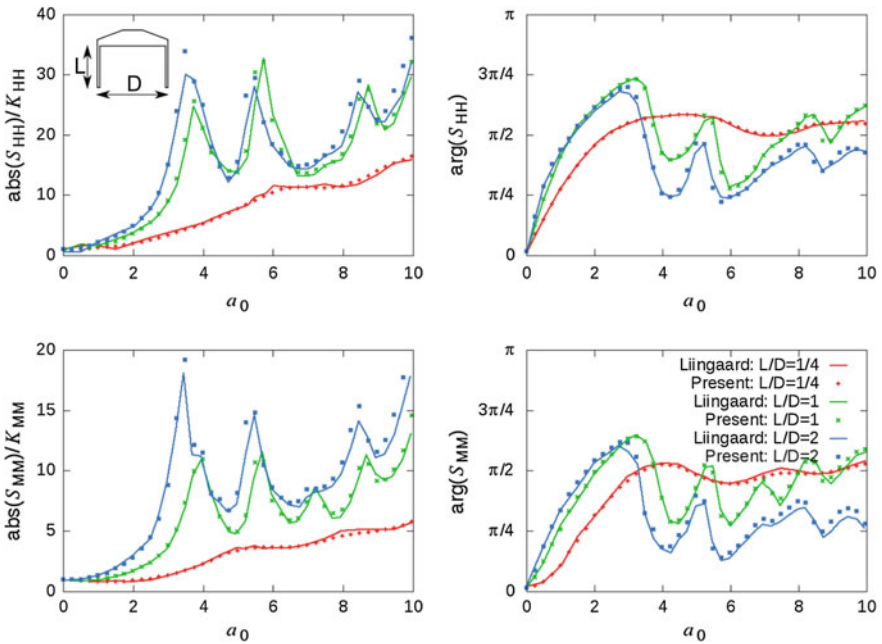
Maeso et al. (2005) for additional details over the poroelastic soil properties and their definitions). Results are presented with regard to the dimensionless excitation frequency  $a_0 = \omega d/c_s$ , being  $\omega$  the excitation frequency in radians per second and  $c_s$  the shear waves (S) propagation velocity in the soil. There are significant differences, no less than 15%, between stiffnesses of the same foundation in limit properties soils (drained or not).

In second place, and as a performance illustration and comparison of the BEM-BEM, BEM-FEM and integral without mesh models described in Sects. 4.1, 4.2 and 4.3 respectively, Fig. 3 presents results corresponding to the response at pile head of a single pile embedded in a homogeneous half-space, subjected to vertical S (left) and P (right) waves. Specifically, the horizontal and vertical displacements are presented of the head of a pile with a slenderness ratio  $L/d = 20$ , normalized by the corresponding displacement produced by incident seismic waves at the free surface without foundation. The internal damping ratio of the soil is  $\beta = 0.05$ , its Poisson coefficient is 0.4, pile-soil Young modulus ratio is  $E_p/E = 1000$ , density ratio is  $\rho_s/\rho = 0.7$ . The results are presented according to the dimensionless excitation frequency  $a_0$ . As can be observed, the results obtained through the three methodologies are practically the same, but the computational cost and the effort needed to prepare input data decreases significantly when going from BEM-BEM (or multidomain BEM), to BEM-FEM or to the meshless model.

Finally, in Fig. 4, verification results of the model described in Sect. 4.4 are presented for the study of suction caissons, comparing results previously presented by Liingaard et al. (2007) for the same problem. Specifically, horizontal and rocking impedances of suction caissons with slenderness ratios  $L/D = 1/4, 1$  and 2 are shown. The viscoelastic soil has a shear modulus of 1 MPa, Poisson coefficient  $1/3$ , density  $1000 \text{ kg/m}^3$  and a hysteretic damping factor of 0.025. The suction caisson is made of steel with Young modulus 210 GPa, Poisson coefficient 0.25 and hysteretic factor 0.01 (considered massless). The caisson radius is  $D/2 = 5 \text{ m}$ , and the skirt thickness is  $t = 5 \text{ cm}$ . The results are made dimensionless with respect to the static values and are very close to the functions used as a reference in this case.



**Fig. 3** Kinematic response at the head of a simple pile to S waves (left) and P waves (right) obtained through different models



**Fig. 4** Horizontal (up) and rocking (down) impedances of a suction caisson in viscoelastic soil for different slenderness ratios

## 6 Conclusions

This communication emphasizes the need to develop advanced computational models for estimating the dynamic response of offshore wind turbine foundations. A state of the art revision of the most commonly used models in the design and dimensioning of these elements is presented, highlighting their application fields, virtues and shortcomings. Four different numerical models developed by the authors have been succinctly described, highlighting different abilities such as the capacity of modeling the actual foundation geometry, considering media of a poroelastic nature, or studying the dynamic response of pile or suction caisson foundations with coupled models of finite elements and boundary elements, or finite elements and integral formulations of the half-space, which allows to drastically reduce the number of degrees of freedom (when compared to pure BEM multidomain or finite element models) without reducing the validity of the results.

**Acknowledgements** This work was supported by the Subdirección General de Proyectos de Investigación of the Ministerio de Economía y Competitividad (MINECO) of Spain and FEDER through the research project BIA2014-57640-R. G.M. Álamo and J.D.R. Bordón are recipients of the FPU research fellowship FPU14/06115 and FPU13/01224 respectively, from the Ministerio de Educación, Cultura y Deporte of Spain. The authors are grateful for this support.



## References

- Abhinav KA, Saha N (2015) Coupled hydrodynamic and geotechnical analysis of jacket offshore wind turbine. *Soil Dyn Earthq Eng* 73:66–79
- Álamo GM, Martínez-Castro AE, Padrón LA, Aznárez JJ, Gallego R, Maeso O (2016) Efficient numerical model for the computation of impedance functions of inclined pile groups in layered soils. *Eng Struct* 126:379–390
- Anastasopoulos I, Theofilou M (2016) Hybrid foundation for offshore wind turbines: Environmental and seismic loading. *Soil Dyn Earthq Eng* 80:192–209
- Arany L, Bhattacharya S, Macdonald JHG, Hogan J (2015) A critical review of serviceability limit state requirements for monopile foundations of offshore wind turbines. In: offshore technology conference, Houston, Texas, USA
- Bhattacharya S, Nikitas N, Garnsey J, Alexander NA, Cox J, Lombardi D, Muir Wood D, Nash DFT (2013) Observed dynamic soil-structure interaction in scale testing of offshore wind turbine foundations. *Soil Dyn Earthq Eng* 54:47–60
- Bhattacharya S, Cox J, Lombardi D, Muir Wood D (2012) Dynamics of offshore wind turbines supported on two foundations. In: Proceedings of the institution of civil engineers – geotechnical engineering 166(GE2), 159–169
- Bhattacharya S (2014) Challenges in design of foundations for offshore wind turbines. *Eng Technol Ref* 1–9. <https://doi.org/10.1049/etr.2014.0041>
- Biot MA (1956) Theory of propagation of elastic waves in a fluid-saturated porous solid. I: Low frequency range. *J Acoust Soc Am* 28(2):168–178
- Biot MA (1962) Mechanics of deformation and acoustic propagation in porous media. *J Appl Phys* 33:1482–1498
- Bordón JDR, Aznárez JJ, Maeso O (2016) Three-dimensional BE-FE model of bucket foundations in poroelastic soils. In: Proceedings of the VII European congress on computational methods in applied sciences and engineering (ECCOMAS 2016)
- Byrne BW, Houlsby GT (2003) Foundations for offshore wind turbines. *Philos Trans R Soc Lond* 361(1813):2909–2930
- Carswell W, Johansson J, Løvholt F, Arwade SR, Madshus C, DeGroot DJ, Myers AT (2015) Foundation damping and the dynamics of offshore wind turbine monopoles. *Renew Energy* 80:724–736
- Cox J, O’Loughlin CD, Cassidy M, Bhattacharya S, Gaudin C, Bienen B (2014) Centrifuge study on the cyclic performance of caissons in sand. *Int J Phys Model Geotech* 14(4):99–115
- Damgaard M, Zania V, Andersen LV, Ibsen LB (2014a) Effects of soil-structure interaction on real time dynamic response of offshore wind turbines on monopoles. *Eng Struct* 75:388–401
- Damgaard M, Bayat M, Andersen LV, Ibsen LB (2014b) Assessment of the dynamic behaviour of saturated soil subjected to cyclic loading from offshore monopile wind turbine foundations. *Comput Geotech* 61:116–126
- Det Norske Veritas AS (2014) Design of offshore wind turbine structures. Offshore Standard DNV-OS-J101
- Dezi F, Carbonari S, Leoni G (2009) A model for the 3D kinematic interaction analysis of pile groups in layered soils. *Earthq Eng Struct Dyn* 38:1281–1305
- EWEA, The European Wind Energy Association (2016) The European offshore wind industry – key trends and statistics 2015, Report
- European Committee for Standardization (2003) Eurocode 8: design of structures for earthquake resistance – Part 5: foundations, retaining structures and geotechnical aspects
- Foglia A, Gottardi G, Govoni L, Ibsen LB (2015) Modelling the drained response of bucket foundations for offshore wind turbines under general monotonic and cyclic loading. *Appl Ocean Res* 52:80–91
- Gazetas G (1984) Seismic response of end-bearing single piles. *Int J Soil Dyn Earthq Eng* 3(2):82–93

- Jin S, Yang Y, Zhang Y (2014) Bucket group effect of the composite multi-bucket structure. *J Mar Sci Appl* 13:62–66
- Jonkman J, Butterfield S, Passon P, Larsen T, Camp T, Nichols J, Azcona J, Martínez A (2008) Offshore code comparison collaboration within IEA Wind Annex XXIII: phase II Results regarding monopile foundation modeling. IEA European wind conference, Berlin, Dec 2007
- Jung S, Kim SR, Patil A, Hung LC (2015) Effect of monopile foundation modeling on the structural response of a 5-MW offshore wind turbine tower. *Ocean Eng* 109:479–488
- Kavvasdas M, Gazetas G (1993) Kinematic seismic response and bending of free-heads piles in layered soil. *Géotechnique* 43(2):207–222
- Kaynia AM, Kausel E (1991) Dynamics of piles and pile groups in layered soil media. *Soil Dyn Earthq Eng* 10:386–401
- Liingaard M, Andersen L, Ibsen LB (2007) Impedance of flexible suction caissons. *Earthq Eng Struct Dyn* 35:2249–2271
- Maeso O, Aznárez JJ, García F (2005) Dynamic impedances of piles and groups of piles in saturated soils. *Comput Struct* 83:769–782
- Madsen S, Pinna R, Randolph M, Andersen LV (2015) Buckling of monopod bucket foundations – influence of boundary conditions and soil-structure interaction. *Wind Struct, Int J* 21(6):641–656
- Mylonakis G (2001) Elastodynamic model for large-diameter end-bearing shafts. *Soils Found* 41(3):31–44
- Musial W, Ram B (2010) Large-scale offshore wind power in the United States. Assessment of Opportunities and Barriers. National Renewable Energy Laboratory, US. <https://doi.org/10.2172/1219151>. <http://www.osti.gov/scitech/servlets/purl/1219151>
- Novak M, Nogami T, Aboul-Ella F (1978) Dynamic soil reactions for plane strain case. *J Eng Mech Div, ASCE* 104(4):953–959
- Pak RYS, Guzina BB (2002) Three-dimensional green's functions for a multilayered half-space in displacement potentials. *J Eng Mech* 128:449–461
- Padrón LA, Aznárez JJ, Maeso O (2007) BEM-FEM coupling model for the dynamic analysis of piles and pile groups. *Eng Anal Bound Elem* 31:473–484
- Poulos HG, Davis EH (1980) Pile foundation analysis and design. Series in geotechnical engineering, Wiley
- Randolph MF (1981) The response of flexible piles to lateral loading. *Géotechnique* 31(2):247–259
- Zaaijer M (2006) Foundation modelling to assess dynamic behaviour of offshore wind turbines. *Appl Ocean Res* 28:45–57

# Development and Characterization of Modular Ceramic and Metal Elements in Vertical Gardens and Ventilated Façades in Buildings



V. Pérez-Andreu, C. Aparicio-Fernández, F. Castilla  
and J.-L. Vivancos

**Keywords** Building · Modelization · Monitorization · Façade

## 1 Introduction

The technology used in ventilated façades has allowed developing façades with vertical gardens. In this study, the behavior of such gardens will be analyzed, specifically the thermal behavior of the ventilated air chamber and it will be compared with a system of ventilated façade with stone cladding. Two systems are presented for vertical gardens installation which are developed by prioritizing basic architectonic and environmental performances over aesthetic spectacularity, complexity and specialization of some of the currently used assemblies. In the authors' opinion, this type of assemblies hinders the generalization of such installations due to an elevated cost. In order to develop vertical gardening systems integrated to buildings, adequately characterized and keeping installation and maintenance costs which allows amortization, the key is to demonstrate that these systems' benefits

---

V. Pérez-Andreu (✉) · F. Castilla

Grupo Medioambiente y Eficiencia Energética en Edificación, Dpto. de Ingeniería civil y de la edificación, Escuela Politécnica de Cuenca, Universidad de Castilla La Mancha, Camino del Pozuelo S/N, 16071 Cuenca, Spain  
e-mail: victor.perez@uclm.es

C. Aparicio-Fernández

Grupo Instituto Interuniversitario de Investigación de Reconocimiento Molecular y Desarrollo Tecnológico, Dpto. de Construcciones Arquitectónicas, Escuela de Ingeniería de la Edificación, Universitat Politècnica de València, Camino de Vera S/N, 46022 Valencia, Spain

J.-L. Vivancos (✉)

Grupo Instituto Interuniversitario de Investigación de Reconocimiento Molecular y Desarrollo Tecnológico, Dpto. de Proyectos de Ingeniería, Escuela Técnica Superior de Ingenieros Industriales, Universitat Politècnica de València, Camino de Vera S/N, 46022 Valencia, Spain  
e-mail: jvivanco@dpi.upv.es

can be useful in the strategy of environmental impact reduction, in new and existing buildings.

### ***1.1 Buildings' Environmental Efficiency in the Climate Change Context***

Forecasts of climate change and fossil energy resources scarcity demand an urgent change on the dwelling models. Dwelling adaptation to the paradigm change implies a controlled reduction of the environmental impact of its production, use and maintenance. To technologically reach this goal, from a local perspective, it is required to have tools and methodological bases, proven, useful, effective and adapted to the specific context, available to professionals of this sector.

According to future projections on climate change in the mediterranean region, an increase of temperature will take place, higher than the global average and more pronounced in the summer months than in winter months. For the RCP8.5 scenario and by the middle of the XXI century, the mediterranean region will experience average temperature increases of 2.2 and 3.3 °C in the winter and summer months respectively (Table 1).

A reduction in the annual precipitation over the Iberic peninsula is also predicted, which will be higher in the southern regions. Precipitations will be strongly reduced in the summer months. For the RCP8.5 scenario and for the middle of the XXI century, the Mediterranean region will experiment average reductions in precipitations of 4% and of 12% in the winter and summer months respectively (Centro Nacional de Educación Ambiental Cambio Climático 2013).

With regard to the energy consumption, the global energy demand is expected to increase 37% until 2040. Energy efficiency will be a fundamental tool to relieve pressure on energy supply (Biroi 2008). The energy consumed in buildings represents 40% of the total energy consumption in the European Union. This sector is currently in a phase of expansion, so the energy consumption will increase in the near future. The direct and indirect environmental impact of edification in Spain can be summarized in the following numbers: between 33 and 42% of primary energy consumption (half of it is used in climate control); between 35 and 50% of the GHG emissions, 40% of mineral resources consumption; 50% of solid waste generation and 18% of total water consumption (Isasa et al. 2014).

**Table 1** Forecast of temperature increase in the mediterranean region for year 2065, RCP8.5. (Centro Nacional de Educación Ambiental Cambio Climático 2013)

Period	Min.	Temperature (°C)	Max.	Min.	Precipitation (%)	Max.
Winter	0.7	2.2	3.1	-24	-4	6
Summer	2.1	3.3	5.6	-31	-12	9
Annual	1.6	2.5	4.1	-23	-7	1

## 2 Enveloping Systems with Vegetation: Environmental Benefits and Challenges for Use Normalization

The most common use of vegetation integration in buildings is through the so called green roofs. This green spaces integration is an opportunity to improve the environmental quality in urban areas. In general terms, their main benefits are related with very different environmental, economical and social aspects, among others: reduction in greenhouse effect gases, adaptation of living spaces to climate change, interior and exterior air improvement in buildings, development of urban biodiversity, etc. These factors are all related and they operate according to a scale range; some being sensible to neighborhood or city scale and others to building scale (Hoyano 1988).

The architectural use of these systems is motivated by esthetic and functional issues of landscape integration in urban conditioning (Pérez et al. 2010) and can also be justified by buildings and environments thermal regulation reasons, energy saving and CO<sub>2</sub> reduction (Köhler 2008), surface material durability and health issues.

Moreover, the environmental benefit should be mentioned. It comes from the use of landscaped covers, based on the reduction of heat gains they provide buildings where they are installed and also the change in the closest environmental conditions through plants photosynthesis and evapotranspiration. Thus, from the result of different studios, it is demonstrated that landscaped covers can effectively cool down their environment by 1.5 °C (Wong et al. 2002).

It is known that the thermal behavior of the landscaped cover affects the building's thermal behavior, because it is integrated in the thermal enveloping of the cover. It is estimated that 27% of the total solar radiation absorbed by the green cover is reflected, while plants and substrate absorb 60%, and in the end only 13% of radiation is absorbed to the enclosure interior. The value of the thermal insulation of a landscaped cover is provided by plants and the substrate layer (England et al. 2004).

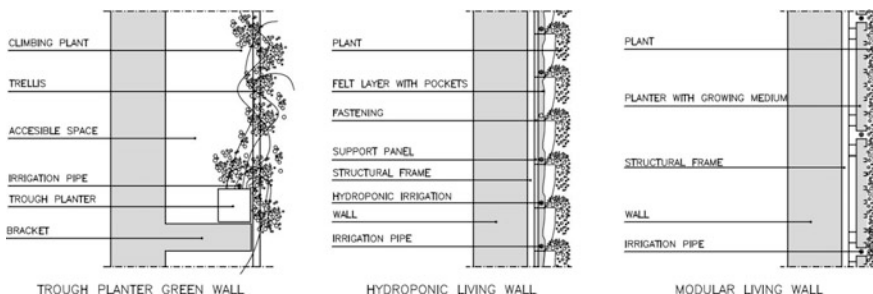
An increasing number of countries, such as Germany, France, United States of America, Canada, Denmark, Japan and Switzerland favor and even regulate the use of green covers in buildings. In the Portland (EEUU) case, the regulation of cover determines the slopes, waterproofing types, drainage, culture medium, even vegetation type. In the Los Angeles (EEUU) case, these covers must be installed following manufacturer specifications and the vegetation have to include self-sufficient plants that do not require pesticides or fertilizers and reach a vegetation cover of 90% in two years (Nolon 2016).

Similarly, the use of vegetation integrated in buildings' vertical enclosures provides environmental, social and economical benefits. This technology, that can be considered even more emergent, is being established as it proves its validity for building design in the climate change context. For this reason, there are authors that propose that vertical vegetation must be clearly characterized to be associated with building design, construction and maintenance.

Generally, two big typologies can be distinguished. On one hand, the green walls, in which the vegetation grows directly over the vertical sides or by means of guide structures that can create intermediate spaces. In this typology, the substrate and irrigation is produced at the plant base, normally in the inferior part, directly over the base ground of the edification, or in horizontal planters distributed by levels. On the other hand, the so called vertical gardens, in which the vegetation roots are distributed over the entire surface, as well as the irrigation systems that normally, also provide nutrients. Vertical gardening is commonly presented in the form of felt panels, or in modular form with sphagnum or substrate containers. In any case, they need ancillary structures which usually are fixed to a previously waterproofed building parameter. This second typology has the possibility to create air chambers, more or less ventilated, depending on the systems. All these types can be used both for the exterior skin and on the internal parameters, and have been independently classified in three systems: modular, felt light panels and trellised planters (Loh 2008).

In a higher or lesser degree, it has been proved that each type of landscaped parameter can favor the building's thermal regulation in different ways. Firstly, a thermal insulation is produced due to the density of foliage, the air chamber situated in the intermediate space and the substrate action. Of course, it also interacts with solar radiation generating shades depending on the density and foliage expiration. The evaporative cooling also has to be taken into account, depending on the plant type, exposition, climate and wind velocity, as well as on the wind variation effect over the building as a function of the density, foliage penetrability and the façade orientation (Palomo 1998). In a more context related way, it is also established that architectural vertical landscaping generates oxygen, reduces suspended matter, filters toxic gases and traps and process heavy metals (Darlington et al. 2000) (Fig. 1).

Studies performed during the last 20 years in different circumstances quantify the different benefits of these systems. Differences of 10 °C have been found in tests, on surfaces with direct vegetation (Hoyano 1988) and 28% reductions on energy consumption for cooling of a building, due to the action of an ivy covered wall (Di and Wang 1999). Through simulations of the vegetation shading over façades, climate control energy consumption reductions of 23% have been



**Fig. 1** Generic typologies of vertical enveloping with vegetation (Own source)

calculated for summer conditions (Bass and Baskaran 2001). These actions over buildings' temperature are also due to the evapotranspiration of plants.

With regard to the urban context, it has been estimated using simulation that when the reflected heat diminish through buildings hard surfaces, streets and pavement, the ambient temperature also decreases up to 8 °C. This value corresponds to a heat urban canyon model 5 m to 10 m in height and 5 m to 15 m in width, with day temperature ranges of 27 and 32 °C, which takes into account vegetation contribution. Thus, it can be considered that controlled integration of vertical gardens in building design will favorably affect cities' microclimate, achieving savings of 32% of the energy consumption for building refrigeration (Alexandri and Jones 2006).

Additionally, green vertical surfaces can provide other environmental benefits, such as the objective reduction of acoustic contamination and they can also favor positive psychoacoustics which gives higher qualification to the space habitability (Haron and Olham 2010). Although green leaves do not have a great capacity of noise absorption by themselves, it can be increased by the planting system array, so in a passive manner these surfaces reduce sound reflection on buildings in cities. This effect is also noted in closed interior spaces where reverberation decreases significantly. In any of these cases, an improvement of the acoustic quality by absorption is produced.

There are other interesting factors to take into account with regard to the green enveloping systems, for example, that hydrological efficiency can be improved in urban environments, because they contribute to a better performance of the water drainage system by reducing and delaying sudden rain water discharges. Although this aspect has been less studied for vertical gardens, it is unquestionable that they can retain rain in a certain degree and also reuse different types of waters.

Despite the benefits of landscaped façades, the viability of their use requires consideration of costs and amortization. There are studies that consider this aspect by a comparative analysis between the different most often used systems. They conclude that from an economic point of view, they behave in different ways due to the different installation and maintenance costs, being the modular type the most difficult to amortize (Perini and Rosasco 2013).

It can be concluded that these systems' contribution to urban spaces and building sustainability as well as the environment in general should be considered in architectural creation and rehabilitation. However, from the point of view of future standardization for use as constructive components or edification systems, there are difficulties to be taken into account. Among others, insufficient constructive characterization and high installation and maintenance costs can be highlighted.

Increasing research efforts are made in these areas. There are specificities given by place, climate and the different behavior of plant species that could be used, that have to be considered. This demands a cautious interpretation of results that make generalizations very difficult. Thus, it is necessary to broaden research at the local level, so these systems operation can be adapted, optimized and controlled to the characteristics of each context.

### 3 Study Objectives

This work intends to characterize two modular vertical garden prototypes, developed under a series of assumptions:

- To take advantage of the qualities of modular landscape systems (possibility to create ventilated chambers, use of leaf shading, substrate humidity conditions, vegetation evapotranspiration and acoustic absorption).
- To use the plants' gripping and nutrition systems. This is done by means of natural substrates with low concentration nutritive solution intake, to avoid excessive growth and to reduce maintenance costs.
- To use wild plant species specific to the installation area, as a strategy for installation and maintenance costs reduction, thus facilitating the environmental integration of the system.
- To create systems that can be manufactured in the final implantation environment (wood, steel sheet and ceramic, in this case), in order to reduce economic and environmental costs necessary for the transportation of materials and products, thus collaborating with the socio-economic context of the area.
- To use steel fastenings with mortar as module support elements, given their economic and constructive effectiveness.
- To take advantage of the physical behavior of the ventilated façades and the ultimately used materials.

Thus, two series of modular landscaped prototypes are designed, in the form of metallic and ceramic crates. The fastenings of the limestone plates that are currently part of a ventilated façade are used to anchor the crates. The façade over which they are installed is oriented to the east and is part of the enclosure of the Escuela Politécnica de Cuenta laboratories. An irrigation and drainage network is installed on them, creating two different systems prepared for the vegetable lining cultivation. Over the landscaped façade and over the stone façade already in place, some sensors are installed to gather temperature and humidity data.

### 4 Methodology and Case Studies

The study described in this communication comprises the construction of prototypes of two new ventilated façade systems, both landscaped, and their subsequent monitoring. The ventilated stone façade is also monitored, in order to compare results between the different typologies. The monitoring has been performed during the month of March 2016.



### 4.1 Description of the Existing Façade System

The ventilated stone façade enclosure is made of a wall constructed with half a foot of solid brick in its exterior part, exterior cement rendering, with 50 mm expanded polystyrene insulation and interior cladding with half a foot of triple hollow brick garnished and coated with plaster. In its exterior part it is covered with limestone plates 70 cm × 40 cm and 3 cm thick, suspended by stainless steel anchors, fastened to the exterior plate of the façade with fast setting mortar. This lining allows leaving 3 mm open joints in the vertical and horizontal directions and an air chamber 4 cm thick.

The thermal transmittance calculated in stationary regime for this façade, according to CTE-HE thermal values for design is  $U = 0.28 \text{ W/m}^2\text{K}$  (Fig. 2).

### 4.2 Description of the Landscaped System with Metallic Crates

The vegetation skin created for the building is nourished and sustained by a substrate of worms and coconut fiber periodically irrigated according to the plants' needs.

To this end, substrate containers have been produced. These containers are 66 cm wide, 36 cm high and 7 cm deep and they have the base and sidewalls made of a 1 mm thick galvanized sheet. The front part of the container is made of electro

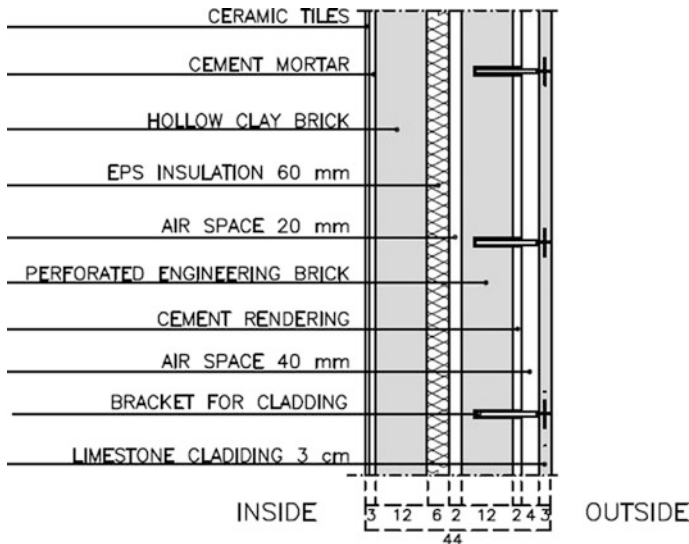


Fig. 2 Existing façade system layout

welded galvanized mesh made with 3 mm rods forming a 10 cm × 5 cm frame. In its interior part, raffia packages are placed with the described substrate.

The metallic crates are bolted to a wood frame made of wild pine boards with a type IV autoclave treatment, forming frames 70 × 40 cm (center distances), 2 cm thick and 7 cm deep, suspended over stainless steel anchors already in place for the stone slabs. The array creates a 4 cm thick air chamber.

As an irrigation system, a drip micro irrigation network is used. This network is used in agriculture and it is formed by polyethylene pipes, filter, water meter and analogue programmer. The nutrient comes from the substrate, which is periodically enriched by a Venturi system.

The plant used to define the carpet comes from local wild species. These plants are placed through holes that the own planter design forms, before the planters are placed and fastened to the steel anchors. The irrigation system is geometrically attached through a slot in the posterior part and holes in the lateral walls (Fig. 3).

The selected species will be added to those which in a natural way grow on walls, rock vegetation or also the so called colonizer plants. These species are adapted to situations in which both water and nutrients are scarce. These species are *Santolina Chamaecyparissus*, *Rosmarinus Officinalis* var. *Posrtrat*, *Thymus Vulgaris*, *Lavandula Latifolia*, *Cerastium Tomentosum* and *Sedum Sp.*

The substrate in which plants are going to develop their roots, and hence of which they are going to attach themselves and from where they are going to obtain water and nutrients to complete their vital cycle, must meet the following requirements: it has to be light, inert and volumetrically stable. It also has to possess an acceptable CEC (cation-exchange capacity: potential to retain nutrients and to regulate their administration), and finally, due to ecological reasons, it has to be

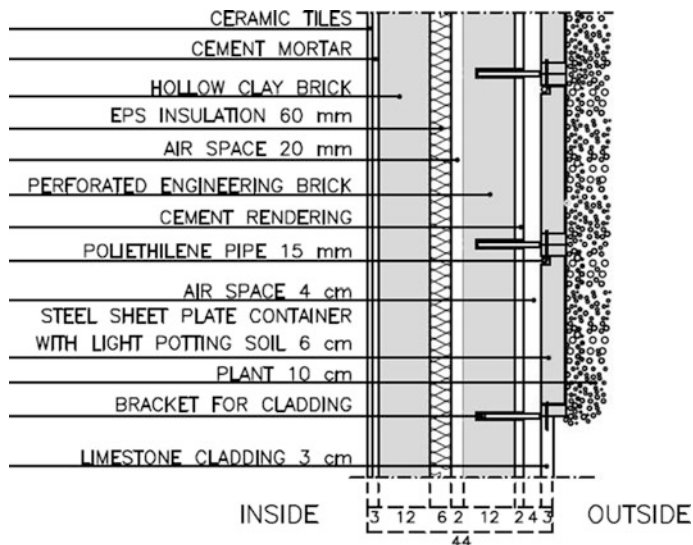


Fig. 3 Layout of the vertical garden system with metallic grates



**Fig. 4** Landscaped system installed to substitute limestone coating

renewable. Due to the characteristics of the cultivation system and of the substrate, it is necessary to guarantee the continuous supply of water and nutrients. Minerals will be supplied with the irrigation water, that is, through fertigation. This is a hydroponic process in which a complete nutritive solution with low mineral concentration is added, to avoid excessive growth (Garcés et al. 2013) (Fig. 4).

The calculated transmittance in stationary regime for this façade, according to CTE-HE thermal values for design is  $U = 0.27 \text{ W/m}^2\text{K}$ .

### ***4.3 Description of the Landscaped System with Ceramic Crates***

Similarly to the system described in the prior section, the vegetation skin is nourished and sustained by a substrate of worms and coconut fiber periodically irrigated according to the plants' needs.

To this end, 16 ceramic containers have been manually produced. These containers are 35 cm wide, 40 cm high and 7 cm deep, with 1.2 mm thick walls and contain the plants' substrate. These crates are suspended with steel anchors fixed with fast-setting mortar. The array also creates a 4 cm thick air chamber. For this case, special dimension anchorages have been produced, which provide a support surface for the modular elements elaborated. A similar irrigation system is used and the nutrient contribution is provided by the substrate and programmed irrigation.

The same local wild plant species are used in this design. These plants are placed through holes included in the planter design, before the planters are placed and fastened to the steel anchors. The irrigation system is also geometrically attached through a slot in the posterior part and holes in the lateral walls.

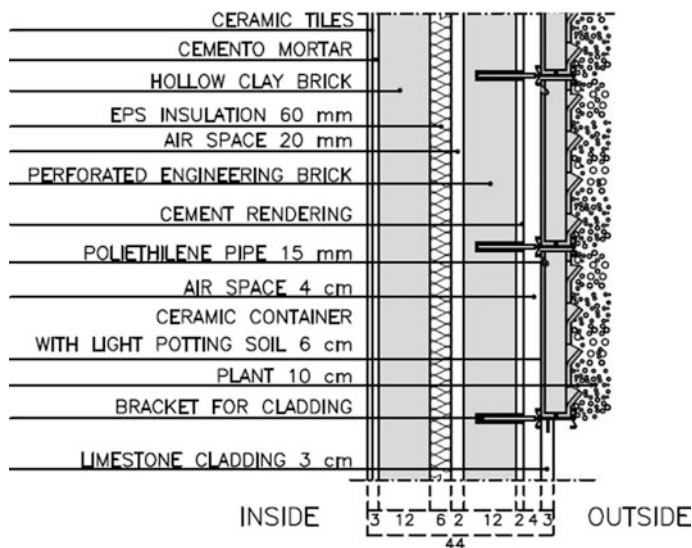


Fig. 5 Layout of the vertical garden system with ceramic grates

The cultivation strategy is similar to that on the metallic crate system and similar plant species will be used. However, in this case a reduction of water consumption is foreseen, due to the humidity retention capacity of the ceramic material and to the containers' design.

The containers have been modeled with red clay and plaster casts. The baking has been performed at low temperature, in order to obtain open pores which favor the evapotranspiration of the water contained in the interior of the crate. This phenomenon is only wanted in the interior face because it is the one in contact with the air chamber. So the porosity in the exterior faces' pores have been covered with the application of a low temperature varnish (Fig. 5).

The calculated transmittance in stationary regime for this façade, according to CTE-HE thermal values for design is  $U = 0.27 \text{ W/m}^2\text{K}$ .

#### 4.4 Description of the Monitoring System

To obtain data of the hygrothermal behavior of the façade systems, a sensor, management and storage system from HOBO is used. The meteorological conditions of the environment and hygrothermal interior conditions are obtained through the meteorological station Oregon Scientific WMRS200, which provides temperature and humidity interior and exterior data.

The management software used is the one provided by the manufacturers of the equipment in use. Measurement synchronization for their analysis is performed through an Openoffice Calc calculation sheet.

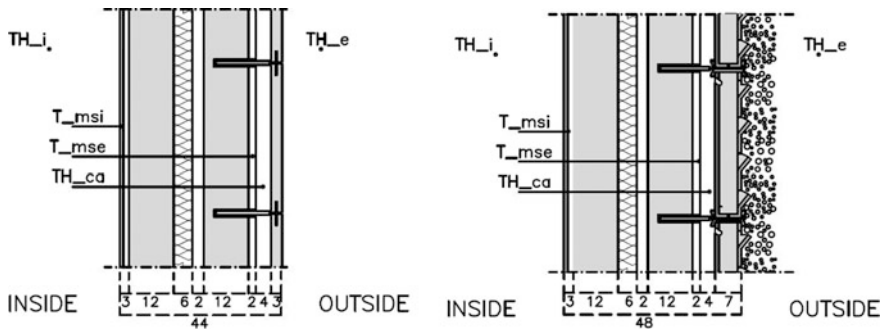


Fig. 6 Sensor disposition in the original and modified enclosure

The monitoring plan consists in temperature and humidity measurement of each façade system at least one week for each season of the year. The equipment used allows monitoring the two constructive systems at the same time, so for each season of the year, data will be obtained simultaneously from the original enclosure, the modified enclosure with ceramic modules and finally, also in parallel, from the two modified enclosures.

For each one of the enclosures, sensors are arranged to measure temperature and humidity of the interior (TH\_i) and exterior (TH\_e) environment, air humidity of the chamber (TH\_ca), and superficial temperatures of the wall’s interior (T\_msi) and exterior (T\_mse). Data are registered every 10 min (Fig. 6).

#### 4.5 Overview of the First Results of the Physical Behavior Monitoring on the Original and Modified Façade with Landscaped Ceramic Modules

The data were registered between March 16th and March 23rd of 2016. Due to the building location, a continental Mediterranean climate is considered. In the initial tests, the vegetation was not in place, in order to identify the effect of the parts and substrate independently of the plants. It is done in order to be able to compare these results with the ones obtained with the vegetation in place, when their growth allows it.

Lower temperatures are obtained in the air chamber corresponding to the lining of the ceramic planters with regard to the existing in the chamber formed by the original limestone plates in the building façade, with ambient temperatures higher than 10 °C approximations. Differences were observed up to 5 °C when the exterior temperature was near 20 °C and 32% relative humidity, characteristics of a spring day on location. It is proved that with low temperatures, both systems results are very similar and they even coincide, but with values over the ambient temperature (Fig. 7).

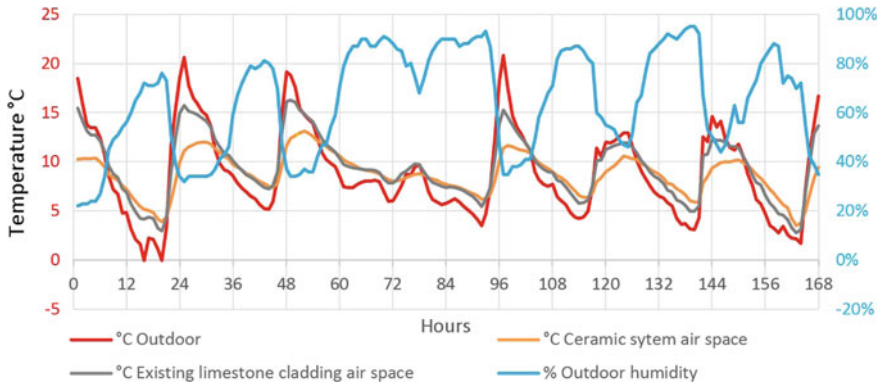


Fig. 7 Representative graph of the compared thermal behavior of the existing limestone façade and the one corresponding to the ceramic planters

#### 4.6 Overview of the First Results of the Physical Behavior Monitoring of Modified Façades with Ceramic and Galvanized Steel Landscaped Modules

The data were registered between March 23rd and March 30th, 2016, in the same place (Fig. 8).

By comparing results among the two landscaped systems, thermal behaviors relatively similar and well below the ambient temperature in average conditions are verified. There is a tendency for the air chamber temperature, when it is composed of ceramic pieces, to approach towards ambient temperature extremes, showing a

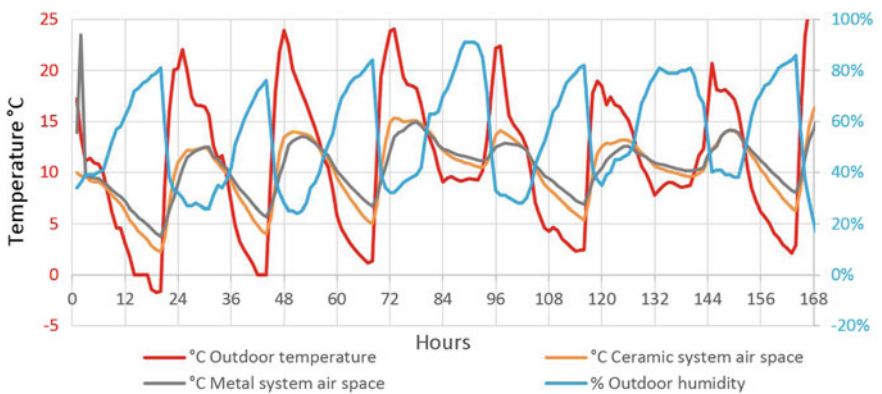


Fig. 8 Representative graph of the compared thermal behavior of the ceramic landscaped façade and the one corresponding to the galvanized steel planters

difference between 0 and 2 °C with regard to the temperature of the air chamber on the metallic planters. In any of the systems, there are noticeable temperature differences between the chamber and the exterior environment.

## 5 Conclusions

It has been possible to develop modules that allow the reutilization of the anchorage systems used in stone ventilated façades. With this action, a reduction in the landscaped façade cost has been achieved.

Initial data confirm expectations of a favorable behavior for air chamber refrigeration, by the two landscaped designs. The tendency observed in the obtained graphs, increases the expectations for better results of these new systems on the tests programmed for autumn due to the ambient temperature rise. These characteristics indicate that caution has to be used when these installations are used in cool environments.

Values increase, in particular, in the ceramic module case, and a transfer of the humidity from substrate to chamber is verified in the measurements. The refrigeration capacity of this vertical garden system will be favored with shading and the evapotranspiration of the plants that are not in the planters at this moment and thus, in the initial tests here presented.

## References

- Alexandri E, Jones P (2006) Temperature decreases in an urban canyon due to green walls and green roofs in diverse climates. *Build Environ* 43(4):480–493
- Bass B, Baskaran B (2001) Evaluating rooftop and vertical gardens as an adaptation strategy for urban areas. CCAF Report B1046. Institute for Research in Construction of Canada
- Birol F (2008) World energy outlook. International Energy Agency, Paris
- Centro Nacional de Educación Ambiental Cambio Climático (2013) Guía resumida del quinto informe de evaluación del IPCC (Grupo de trabajo I). Biodiversidad Oficina Española de Cambio Climático Agencia Estatal de Meteorología, Madrid
- Darlington A, Chan M, Malloch D et al (2000) The biofiltration of indoor air: Implications for air quality. *Indoor Air* 10:39–46
- Di H, Wang DN (1999) Cooling effect of ivy on a wall. *Exp Heat Transf* 12:235–245
- England E, Morgan B, Usrey L et al (2004) Vegetated roofing technology: an evaluation. In *LCA/LCM 2004*. The American Center for Life Cycle Assessment
- Garcés S, Castilla FJ, Pérez V (2013) Agrotecnología y eficiencia energética: prácticas de jardinería vertical aplicada a la edificación para alumnos del grado superior. I Encuentro de Experiencias Docentes en Educación Superior en Energía y Medioambiente: University Vocational Training Network. Ciudad Real
- Haron Z, Olham D (2010) A Markovian approach to the modelling of sound propagation in urban streets. *Jurnal Teknologi* 52:61–75
- Hoyano A (1988) Climatological uses of plants for solar control and the effects on the thermal environment of a building. *Energy Build* 11:181–199

- Isasa M, Gazulla C, Zabalza I et al (2014) Herramienta EnerBuilCA para el análisis del ciclo de vida de edificios y su adaptación al contexto urbano. II Congreso EECN: Edificios de Emisiones de Ciclo de Vida casi cero. Grupo Tecma Red y Ministerio de Fomento de España. Madrid
- Köhler M (2008) Green facades—a view back and some visions. *Urban Ecosyst* 11(4):423–436
- Loh S (2008) Living walls: a way to green the built environment. *Environment Design Guide – TEC 26*. Australian Institute of Architects
- Nolon JR (2016) Enhancing the urban environment through green infrastructure. 46 *Environmental Law Reporter*. Citation: 46 ELR 10071 Available via DIALOG. <http://digitalcommons.pace.edu/lawfaculty/1011/>
- Palomo E (1998) Analysis of the green roofs cooling potential in buildings. *Energ Build* 27:179–193
- Pérez G, Vila A, Castell C, Cabeza L (2010) Ensayos con arquitectura vegetada. *Seguridad y medioambiente* 118:34–45
- Perini K, Rosasco P (2013) Cost benefit analysis for green façades and living wall systems. *Build Environ* 70:110–121
- Wong NH, Wong VL, Chen Y et al (2002) The thermal effects of plants on buildings. *Archit Sci Rev* 45:337–348



# Qualitative Analysis on Risk Assessment in Photovoltaic Installations: Case Study in the Dominican Republic



Guido C. Guerrero-Liquet, M. Socorro García-Cascales  
and Juan M. Sánchez-Lozano

**Abstract** The banks of the Dominican Republic require a risk analysis that covers technical, environmental and economic considerations to access financing in renewable energy projects. Management and risk assessment are key requirements for financial viability. For this reason there is a need to model practical tools to help investors know the risks and reduce the probability of them occurring. In this way potential investors can more easily assess the profitability, risks and impacts of renewable energy facilities. To do this the probability and impact matrix with multi-criteria decision-making methods are combined in this study. A qualitative risk analysis is applied to a solar energy system in the Dominican Republic. In this study, the probability and the impact of the risks (high, medium, low) are assessed to determine the priority with which they should be addressed. The urgent priority is modeled in terms of time, cost, performance and risk scope. The experts determine the severity of the risks knowing the design of the project. Qualitative analysis alone does not guarantee the success of the project but can help to decide which uncertainties should be addressed before and during the project's useful life.

**Keywords** Decision-making · Renewable energy (RES) · Qualitative risk Photovoltaic systems (PV) · Dominican republic (RD) · Probability and impact

---

G. C. Guerrero-Liquet (✉) · M. S. García-Cascales  
Dpto. de Electrónica Tecnología de Computadoras y Proyectos, Universidad Politécnica de Cartagena, Plaza del Hospital nº 1, 30202 Cartagena, Murcia, Spain  
e-mail: gcgl0@alu.upct.es

M. S. García-Cascales  
e-mail: socorro.garcia@upct.es

J. M. Sánchez-Lozano  
Centro Universitario de la Defensa de San Javier, Academia General del Aire, Universidad Politécnica de Cartagena, C/ Coronel López Peña S/N, 30720 Murcia, Spain  
e-mail: juanmi.sanchez@ cud.upct.es

## 1 Introduction

The renewable energy (RES) sector has, in recent years, become a reality, especially in large developing countries such as India, China and Brazil. The increase in new solar photovoltaic facilities around the world is proof of strong support policies and the rapid decrease in technology costs. However, small island developing countries have barely begun the transition towards a greater use of renewable energy resources (Heinrich Blechinger and Shah 2011).

To foster this transition, emerging countries apply risk management and assessment mechanisms to achieve the necessary financial viability. The momentum to carry out renewable energy projects has been mainly motivated by the financial sector, foreign investment and government support.

The Dominican Republic (DR) is currently an example of this since banks with international funds, in combination with government institutions, promote risk analysis to resort to project financing (Ochs et al. 2015). These analyses use technical, environmental and economic considerations to establish sustainability criteria in solar, wind, biomass, hydroelectric and other energy producing installations.

Although DR is a country which shows a huge solar potential (especially in the main cities), there is currently no firm commitment to ensure that a favorable legislative framework is maintained. Therefore, potential investors still believe that the implementation of projects of this type involves a high degree of risk.

As risk continues to be a strong barrier to financing renewable energy projects, it is necessary to analyze not only their risk reduction mechanisms, but also their implementation in those areas where they are considered appropriate (Ochs et al. 2015).

To mitigate these risks and increase the confidence of potential investors, it is necessary to create practical tools that help to understand the risks and to thus decrease the probability of them occurring. In this way, developers and project investors can more easily evaluate the profitability, risks and impact of such facilities.

## 2 Objectives

The main objective of this study is to evaluate the probability and impact of the risks and to obtain the priority with which the risks that affect the profitability of the photovoltaic installations located in the DR must be dealt with.

The qualitative analysis of risks is the process of prioritizing the risks for subsequent actions combining the probability of their occurrence and the impact of those risks. In order to obtain the prioritization in which these risks must be addressed, a multicriteria decision-making analysis will be applied.

For this purpose, the probability and impact matrix applied by the project management body of knowledge (PMBOK 5<sup>o</sup> Spanish Edition 2012) will be used. In this qualitative risk analysis, the results obtained in this matrix will be combined with multicriteria decision-making methods.

The priority of urgency is modelled in terms of time, cost, performance and severity of the risks in a solar installation located in Santo Domingo, DR. The domestic and international banking sector remains reluctant to offer loans due in large part to the perceived risks of these investments (Ochs et al. 2015). With the results obtained in this study it is intended to help reduce the risks which private investors still perceive in projects of renewable energy facilities.

### 3 Qualitative Analysis of Risks in Renewable Energies

There is currently very little literature on qualitative risk analysis in renewable energies. To date some studies have been carried out (Gatzert and Kosub 2016), although none applying to projects of solar facilities. For example, studies have been carried out that qualitatively evaluate the risks of impacts on marine habitats (Astles et al. 2009). In that work, the risks used in the assessment of specific ecological components were defined as the likelihood that activities in the fisheries sector would lead to unsustainable impacts.

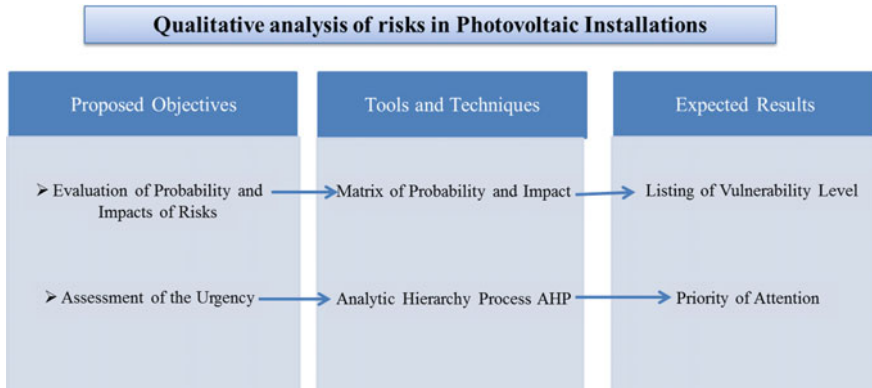
Recently, the qualitative risk assessment of a dual fuel system (LNG-Diesel) has been carried out (Stefana et al. 2016). The study shows the phases of the risk assessment process, according to ISO 31000. It defines qualitative analysis as the “process of understanding the nature of risk and determining the level of risk”.

Although there is no single definition for the concept of qualitative analysis, they are all routed toward risk prioritization and the probability of occurrence impact. That is why the (PMBOK 5<sup>o</sup> Spanish Edition 2012) guide defines qualitative risk analysis as “the process of prioritizing the risks for performing further analyzes or actions, evaluating and combining the probability of occurrence and the impact of those risks”.

Conducting qualitative risk analysis is usually a quick and economical means of project risks assessment. It sets priorities for planning the response to risks. It also lays the foundations for the quantitative risk analysis, if required. The process should be reviewed throughout the project’s life cycle to keep it up to date with changes in project risks.

By performing a qualitative analysis of the risks of a project, the information of the registry of the risks is updated, thus obtaining: a list of risk priorities, a list of risks requiring short-term response, a list of risks requiring additional analysis and response, and monitoring lists for low priority risks.

The most representative actions of the process of qualitative analysis in risk management according to the PMBOK guide are the evaluation of probability and impact of the risks, and the evaluation of the urgency of the risks. These actions are not repeated in any other stage of the risk management process.



**Fig. 1** Proposed work scheme (*compiled by authors*)

The first action examines the occurrence of each specific risk and investigates its potential effect on a project objective. Risks can be assessed in interviews or meetings with participants selected because of their familiarity with the project agenda. These include project team members and non-project experts (PMBOK 5<sup>o</sup> Spanish Edition 2012).

On the other hand, the risk assessment of urgency is determined from the results of assessing the probability and impact to obtain the severity of the risk. At this stage the urgency is evaluated, taking into account the priority of attention in terms of time, cost, performance and the scope of risks.

In order to carry out the aforementioned actions and thus perform a qualitative analysis of the risks in photovoltaic solar installations, in the present study a specific analysis process is proposed, detailed in Fig. 1. This shows the proposed objectives, the tools and techniques used and the results that are sought.

To achieve the proposed objectives, two techniques will be combined: One usually used in risk management (probability and impact matrix) (Astles et al. 2009) and the other, a widely used expert judgment evaluation technique developed by Saaty (2000) denominated the AHP (Analytic Hierarchy Process) methodology. Each of the techniques and tools used in the present study will be explained below.

### **3.1 Matrix of Probability and Impact of Risks**

Usually, the evaluation of probability and impact and, therefore, the level of vulnerability, are carried out using a search table or a probability and impact matrix. It is the most used technique in the qualitative analysis of risks and opportunities.

This matrix is a two-dimensional table in which probability is crossed with the severity of the consequences analyzed. The experts assign a numerical weighting on the probability of occurrence (from 0.10 to 0.90). Subsequently, in order to sort the

risks and classify them according to their priority (high, medium, low), a numerical weighting is applied to the impact of each risk (from 0.05 to 0.80). This matrix that applies the project management body of knowledge (PMBOK 5<sup>o</sup> Spanish Edition 2012) raises the so-called triangle (red) of attention that corresponds to the risks classified with high priority.

Opportunities and risks can be managed in the same matrix, using the definitions of the different impact levels appropriate to each of them. Each risk is classified according to its probability and its impact.

The number of stages in the scale will be determined by the project developers. In the case of the proposed study, the data represent the increasing vulnerability to which the risks in the photovoltaic installations are subjected and the increase of the seriousness of these consequences.

### ***3.2 Techniques Expert Judgment. Analytic Hierarchy Process***

Expert judgment is necessary to assess the probability and impact of each risk as well as to determine its location within the matrix and to obtain the attention priority from the risks. Obtaining expert judgment on risk is often achieved through questionnaires to experts. The partiality of experts in this process must be taken into account.

This study proposes to apply multi-criteria decision-making through the analytic hierarchy process AHP methodology (Saaty 2000) to evaluate the urgency of the risks. The AHP method allows solving a problem posed quickly and simply. AHP proposes a way to sort analytical thinking, which includes three basic principles: the principle of building a hierarchy, the principle of prioritization and the principle of logical consistency (Guerrero-Liquet et al. 2014).

By means of this methodology, the problem is modeled through a hierarchical structure. Using priority scales based on the preference of one element over another, AHP synthesizes the judgments issued and provides a ranking or ordering of the alternatives according to the weights obtained (Arancibia et al. 2003).

## **4 Case Study**

The case study is the construction of a solar photovoltaic installation in the parking area of a building for administrative use, namely the central offices of a bank in the city of Santo Domingo (Dominican Republic). This solar installation is intended to cover part of the demand for electrical energy in this building (Guerrero-Liquet et al. 2015).

The technical, physical and economic characteristics of the installation are detailed below to enable the extraction of the expert knowledge, Fig. 2.

Summary of the project conditions defined				
Project Location	Technical Characteristics	Design	Power Consumption	Economic Analysis
<ul style="list-style-type: none"> <li>&gt; Solar installation</li> <li>&gt; City Santo Domingo</li> <li>&gt; Grid Connected</li> <li>&gt; Location: Park Caribbean Bank</li> <li>&gt; Area: 761.5 m<sup>2</sup></li> <li>&gt; Latitude: 18.47 N</li> <li>&gt; Altitude: 56 m</li> <li>&gt; Tilt Optima: 8.470</li> <li>&gt; Azimuth: 00°</li> </ul>	<ul style="list-style-type: none"> <li>&gt; Radiation: 4.01 Kw·h/ m<sup>2</sup>·day</li> <li>&gt; Suniva panels 300 w MVX300</li> <li>&gt; Number of Panels = 380</li> <li>&gt; Wind speed: 167 kph</li> <li>&gt; Used area: 737 m<sup>2</sup></li> <li>&gt; Lifespan: 25 years</li> <li>&gt; Investors Fronius CL 55.5 Delta</li> <li>&gt; Total Investors = 2</li> <li>&gt; Rated Power Inverter = 56 Kw</li> </ul>	<ul style="list-style-type: none"> <li>&gt; Processing Performance 80%</li> <li>&gt; 10 panels in series</li> <li>&gt; 38 Parallel Panels</li> <li>&gt; Tracking Performance 96%</li> <li>&gt; Inv Umax = 600 V</li> <li>&gt; Umin = 230 V inv</li> <li>&gt; Mounting System: Unirac</li> <li>&gt; 5 Combiner Box</li> <li>&gt; Rated Power Generator = 114 Kw</li> </ul>	<ul style="list-style-type: none"> <li>&gt; Average consumption: 66461.54kWh /Month</li> <li>&gt; Estimated consumption: 114.00kWh / day</li> <li>&gt; Annual consumption: 864,000kWh</li> <li>&gt; Monthly production: 12515.17kWh</li> <li>&gt; Saved Consumer percentage: 19%</li> <li>&gt; Annual Power: 2609.76 Kw</li> <li>&gt; Monthly Production value = 2223.97 US \$</li> <li>&gt; Average Annual Power: 200.75 kw / month</li> <li>&gt; Average Energy Standard: 180.71 Wh / Wp</li> </ul>	<ul style="list-style-type: none"> <li>&gt; Cost= 234.014,25 US\$</li> <li>&gt; Law discount = 40%</li> <li>&gt; Estimated Annual savings = US \$ 26,687.63</li> <li>&gt; Kwh price= 0,18 US\$</li> <li>&gt; Profit in 10 years: US \$ 156,212.60</li> <li>&gt; Pay Back: 5 years</li> <li>&gt; Profit in 25 years: US \$ 924,707.99</li> <li>&gt; TIR in 10 years: -3%</li> <li>&gt; TIR in 25 years: 20%</li> </ul>

Fig. 2 Collection of documents (*compiled by authors*)

#### 4.1 Selection of Risks and Criteria

Risk identification had been carried out through a group of five experts in a previous study (Guerrero-Liquet et al. 2016). In this study, the experts identified the risks of the installation through a combination of methods following the guidelines and recommendations of a project management body of knowledge (PMBOK 5° Spanish Edition 2012).

In this study, an order of importance could be established for each of these risks. The risks identified by experts include:

- R1. High Pay Back: Long time it takes to recover the initial outlay invested in the production process.
- R2. Shadows losses: Losses of solar radiation by photovoltaic installations due to shadows.
- R3. Maintenance Costs: Total price to pay for cleaning dirt from the solar panels over the lifetime of the installation.
- R4. Atmospheric Phenomena damage: Earthquakes, hurricanes, storms etc., which may cause damage to the facility.
- R5. Variability NPV: It is the route as a percentage of the project's profitability. The net present value or net present value of an investment is an indicator of net absolute return provided by the project. It measures the baseline and the benefit provided in absolute terms, after discounting the initial investment.
- R6. Lack of Maintenance: Effects caused by not cleaning the dust and dirt of a facility over its lifetime.
- R7. Changes in the legislative framework: Different changes that may arise in current legislation and rules governing aids applied to this type of investment.
- R8. Lack of replacements and supplies: Replacement of any component or structure which prevents efficiency during the life of the installation.

- R9. Lack of Financing: no bank loans or funding to support the project investment.

With regard to the criteria used for the risk urgency assessment, these have also been selected on the basis of the (PMBOK 5° Spanish Edition 2012). This guide establishes, in the risk management section, both the priority indicators for responding to risks and the symptoms and warning signs in terms of care. These criteria are the defined conditions of the impact of a risk on the main objectives of the project:

- C1. Time: when the risk can occur and how long it lasts.
- C2. Cost: economic cost of potential problems that the risk will cause.
- C3. Performance: the risk performance throughout the project.
- C4. Scope: seriousness or repercussions that the risk may have on the different parts of the project.

## 4.2 Evaluation of Probability and Impacts of Risks

In this stage, the probability and impact priority of the risks and the level of vulnerability of each of them are obtained by applying the probability and impact matrix according to the effects of profitability and the probability of occurrence. In order to apply this matrix, a questionnaire was elaborated that allowed to evaluate the priority and the impact of each risk independently. The questions in this questionnaire are detailed below for each of the risks:

1. Select the probability of occurrence that this installation has X risk.

1      3      5      7      9

Where:

- 1: Probability of minimum occurrence
- 3: Probability of occurrence between minimum and medium
- 5: Probability of medium occurrence
- 7: Probability of occurrence between medium and high
- 9: Probability of high occurrence
- Select the impact (%) that can cause X risk in the installation.

5      10      20      40      80

Where:

- 5: Low Impact
- 10: Impact between Low and Medium
- 20: Medium Impact
- 40: Impact between Medium and High
- 80: High Impact

The series of numerical weights obtained were introduced into the probability and impact matrix (Table 1). By multiplying the rows and columns with each other it was possible to obtain the input value to the matrix and calculate the priority of the probability and impact of the risks for each expert.

With this matrix, three groups of risk probability and impact levels are defined:

- Low priority: risks belonging to this group should be included in a monitoring and supervision list.
- Medium priority: this group of risks must have a proactive management action.
- High priority: this group of risks needs action priority and aggressive response strategies.

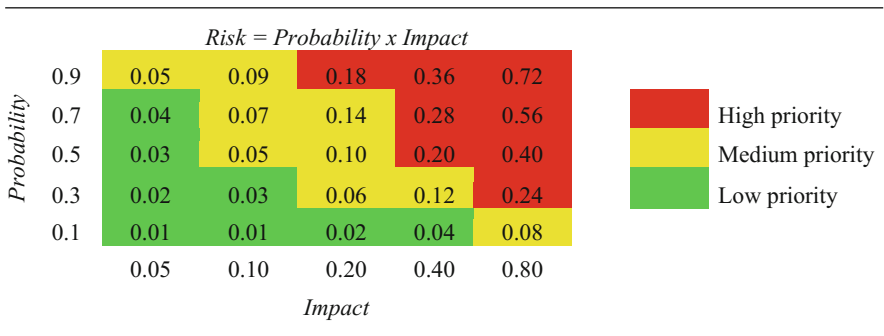
To obtain a global average of the results, the geometric mean was applied to the probability and impact values obtained from each risk (Table 2).

Showing the final results in graph form (Fig. 3), it is possible to see at first glance that there is an intermediate group of four acceptable risks (medium priority); another group of four risks requiring further analysis (high priority) and a single low priority risk.

At the end of this stage, a list was prepared that reflects the level of vulnerability of each risk (high, low or moderate) based on the probability and impact priority obtained (Table 3).

From this list it is evident that only the risk R8 (lack of replacements and supplies) has a low level of vulnerability. This risk should be monitored to be taken into account in long-term contingencies. Risks R2, R3, R5 and R6 have a moderate level of vulnerability and the remaining risks are of high vulnerability.

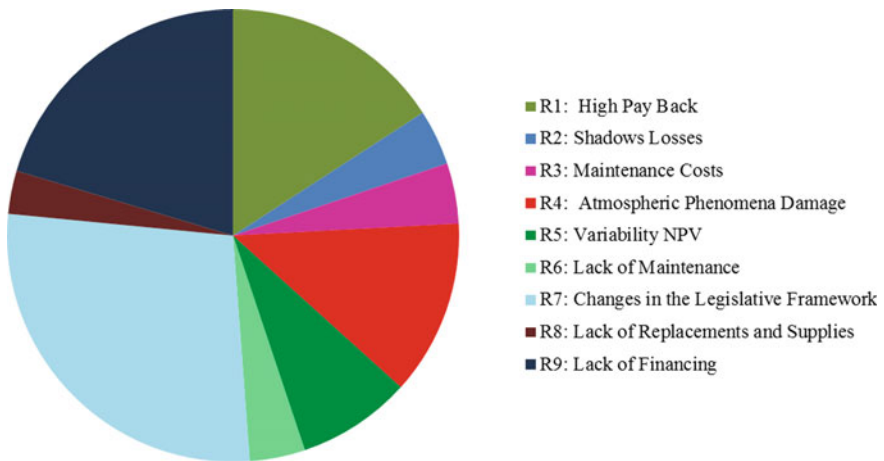
**Table 1** Matrix of probability and impact (*compiled by authors*)





**Table 2** Calculation of the probability and impact of the risks (*compiled by authors*)

Risk	Expert 1	Expert 2	Expert 3	Expert 4	Expert 5	Overall Result
<i>R1: High Pay Back</i>	0.24	0.20	0.20	0.24	0.24	0.22 High priority
<i>R2: Shadows Losses</i>	0.03	0.06	0.03	0.12	0.10	0.06 Medium priority
<i>R3: Maintenance Costs</i>	0.14	0.04	0.05	0.20	0.02	0.06 Medium priority
<i>R4: Atmospheric Phenomena Damage</i>	0.36	0.40	0.02	0.28	0.28	0.18 High priority
<i>R5: Variability NPV</i>	0.06	0.28	0.10	0.20	0.06	0.12 Medium priority
<i>R6: Lack of Maintenance</i>	0.02	0.04	0.56	0.04	0.03	0.06 Medium priority
<i>R7: Changes in the Legislative Framework</i>	0.28	0.72	0.40	0.20	0.56	0.39 High priority
<i>R8: Lack of Replacements and Supplies</i>	0.01	0.08	0.04	0.04	0.12	0.04 Low priority
<i>R9: Lack of Financing</i>	0.28	0.40	0.72	0.20	0.12	0.29 High priority



**Fig. 3** Results of probability and impact of risks (*compiled by authors*)

**Table 3** Listing of vulnerability level of risks (compiled by authors)

Low Risk	Moderate Risk	High Risk
R8: Lack of Replacements and Supplies	R2: Shadows Losses	R1: High Pay Back
	R3: Maintenance Costs	R4: Atmospheric Phenomena Damage
	R5: Variability NPV	R7: Changes in the Legislative Framework
	R6: Lack of Maintenance	R9: Lack of Financing

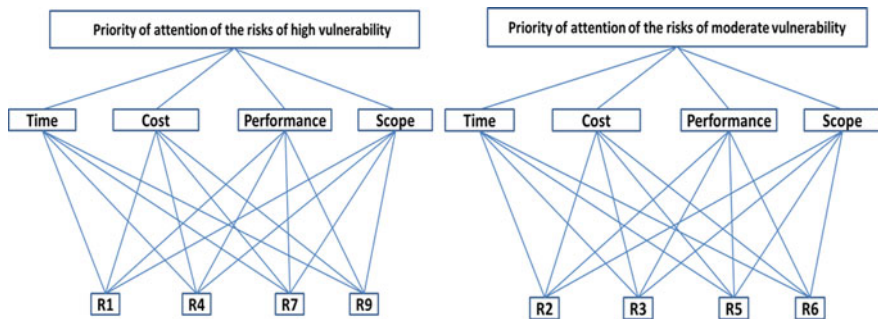
### 4.3 Assessment of the Risk Urgency

After obtaining two groups of risks that require short-term actions, the next stage of the qualitative analysis of risks begins. It consists of considering the priority in which each of the risks mentioned must be addressed according to the group they belong to.

To obtain the priority of urgency of the risks according to the vulnerability (moderate or high) the AHP methodology was applied. To do so, a questionnaire was elaborated using the preference scale (Saaty 2000). The hierarchical structure of the AHP methodology for the particular case proposed was composed of three levels (Fig. 4): objectives, criteria, and risks according to the level of vulnerability obtained (Table 3).

The questionnaire consisted of two clearly differentiated parts. The first would allow the local priorities of the criteria to be established by comparing each pair of criteria and assessing their importance with respect to the other.

The second part would provide the local priorities of the risks, comparing each risk and assessing its importance with respect to the other for each of the criteria. The results obtained in this questionnaire were modeled in a spreadsheet.



**Fig. 4** AHP case hierarchical structures (compiled by authors)

The consistency index for each of the experts was calculated in order to check whether the judgments of the experts should be reviewed and to thus obtain the importance of the risks.

Finally, to obtain the results of the judgments of the experts in a global form, a homogenous aggregation was carried out using the geometric average. After applying the AHP methodology, the priority of attention of each risk was obtained according to the level of vulnerability (high or moderate) (Table 4).

With these results it is possible to establish an emergency order to address the problems that affect the profitability of the photovoltaic installation. The criteria with the greatest weight in the decision were C4 (scope) and C2 (costs) and the criteria with lowest weight were C3 (performance) and C1 (time).

The risk that most demands attention is the financial risk R7 (changes in the legislative framework) since it is the risk of high level of vulnerability that obtained the highest attention priority, Fig. 5.

In that same order, R7 is followed by R9 (lack of financing) which is another financial risk. R4 (atmospheric phenomena damage) is in the third position of attention which is the only risk of a technical type that has a high level of vulnerability.

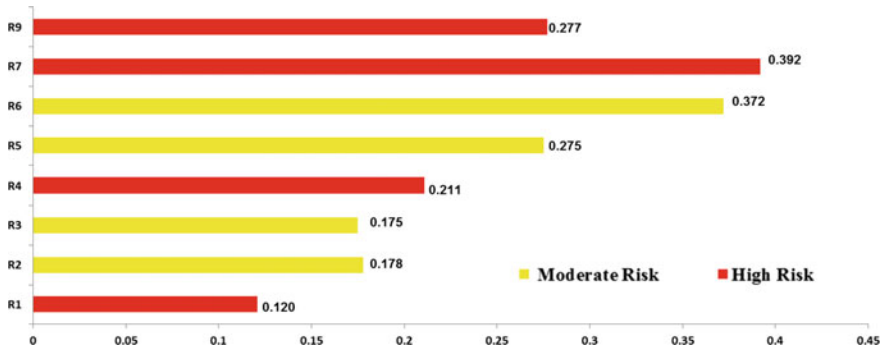
The last priority of attention among the risks of high level of priority is R1 (high pay back), the justification to this result could be in the dependence that this risk presents with the established legislative framework.

As for the risks with a moderate level of vulnerability, it is interesting to note that R6 (lack of maintenance) is the technical risk that presents a higher attention priority followed closely by the financial risk R5 (NPV variability), which denotes a greater importance of the financial risks globally.

The third order of priority is provided by the technical risk R2 (shadows losses), with the financial risk R3 (maintenance costs) being in last place. This is probably due to its high risk linked with R6 (lack of maintenance).

**Table 4** Priority of attention of the risks with analytic hierarchy process (*compiled by authors*)

Moderate Risk	Weights	Priority of Attention
R2: Shadows Losses	0.178	3
R3: Maintenance Costs	0.175	4
R5: Variability NPV	0.275	2
R6: Lack of Maintenance	0.372	1
High Risk	Weights	Priority of Attention
R1: High Pay Back	0.120	4
R4: Atmospheric Phenomena Damage	0.211	3
R7: Changes in the Legislative Framework	0.392	1
R9: Lack of Financing	0.277	2



**Fig. 5** Coefficient of importance of the risks according to AHP (*compiled by authors*)

Risks that have a moderate level of vulnerability are placed on a secondary level in order of importance and proactive actions are taken with each one. On the other hand, the risks of high level of vulnerability must be subjected to aggressive actions and strategies to respond to mitigations and contingencies as appropriate, depending on the priority of care obtained.

## 5 Conclusions

Determining the severity and priority of attention of each of the risks to which the project is exposed fulfils the main objective of this study. With the results obtained, the investors and developers will find it easier to evaluate the profitability, the impact and the probability of risk occurrence for a photovoltaic solar installation.

This analysis reveals the uncertainties that should be addressed before and during the useful life of this type of projects. First of all, the financial risk R7 (changes in the legislative framework) is established. It is therefore demonstrated that this type of facilities should under no circumstances be subjected to retroactive changes in their regulations and subsidies as their profitability could be immediately affected.

On the other hand, it is important that the project receives solid funding to ensure an appropriate return on investment. Regarding the technical aspects, it is obligatory to take into account the necessary provisions so that there is no damage to the infrastructure of the facility, as the insular country where the facility is located (in the Caribbean) is subjected to continuous adverse weather conditions.

One single risk has been identified by the experts as being less important, specifically R8 (replacements and supplies), being placed on a low priority risk supervision list for continuous monitoring. The results obtained in this risk demonstrate its close connection with the maintenance of the facility which must be subjected to proactive management.

As for the methodology applied, it should be noted that the impact and probability matrix allowed the search for priority attention to the risks. The AHP methodology guaranteed a consensual selection by all the actors involved in the decision-making process, providing an effective measure of the consistency of each expert.

This qualitative analysis guarantees the quality of the subsequent actions of the risk management process and has allowed the risks that need short-term responses to be identified.

As proposals for future research it is interesting to mention the difficulties to obtain quantifiable data. This is why it is not possible to perform a more exhaustive study through a quantitative analysis of the risk that allows planning the responses of mitigation and contingency of the risks in an efficient manner. Another line of research could be to analyze the risk and the potential consequences that arise from clear estimates over time.

**Acknowledgements** This work is partially supported by projects TIN2014-55024-P from the Spanish Ministry of Science and Innovation and P11-TIC-8001 from Junta de Andalucía (including FEDER funds), and the project 19882/GERM/15 SÉNECA 2004 program in addition to the doctoral scholarship from the Ministry of Higher Education from the Dominican Republic (MESCYT) with the contract number 1065–2015, respectively.

## References

- Arancibia S, Contreras E, Mella S, Torres P, Villablanca I (2003) Multicriteria Evaluation: application for the formulation of sports infrastructure projects. University of Chile
- Astles KL, Gibbs PJ, Steffe AS, Green M (2009) A qualitative risk-based assessment of impacts on marine habitats and harvested species for a data deficient wild capture fishery. *Biol Cons* 142 (11):2759–2773. <https://doi.org/10.1016/j.biocon.2009.07.006>
- Gatzert N, Kosub T (2016) Risks and risk management of renewable energy projects: The case of onshore and offshore wind parks. *Renew Sustain Energy Rev* 60:982–998. <https://doi.org/10.1016/j.rser.2016.01.103>
- Guerrero-Liquet GC, Sánchez-Lozano JM, García-Cascales MS, Ortuño A (2014) Comparison of AHP/ANP decision making methodologies in a case study of renewable in the Dominican Republic [http://www.aepro.com/files/congresos/2014alcaniz/CIDIP2014\\_1561\\_1575.4269.pdf](http://www.aepro.com/files/congresos/2014alcaniz/CIDIP2014_1561_1575.4269.pdf)
- Guerrero-Liquet GC, Sánchez-Lozano JM, García-Cascales MS, Faxas-Gúzman (2015) Risk management in the renewable energy field: comparative analysis and study case in the Dominican Republic. <http://www.aepro.com/files/congresos/2015granada/05033.4452.pdf>
- Guerrero-Liquet GC, Sánchez-Lozano JM, García-Cascales MS, Lamata MT, Verdegay JL (2016) Decision-making for risk management in sustainable renewable energy facilities: a case study in the Dominican Republic. *Sustainability* 8(5):455. <http://www.mdpi.com/2071-1050/8/5/455> <https://doi.org/10.3390/su8050455>
- Heinrich Blechinger PF, Shah KU (2011) A multi-criteria evaluation of policy instruments for climate change mitigation in the power generation sector of Trinidad and Tobago. *Energy Policy* 39(10):6331–6343. <https://doi.org/10.1016/j.enpol.2011.07.034>
- Ochs A, Konold M, Matthew Lucky S, Musolino E, Ahmed A, Weber M (2015) Harnessing energy resources sustainable of the Dominican Republic. World watch Institute, Washington, DC
- PMBok (2012) project management institute “project management body of knowledge (Guide PMBOK)”. 5a Ed, Pennsylvania USA

Saaty TL (2000) Fundamentals of decision making and priority theory with the analytic hierarchy process. RWS Publications

Stefana E, Marciano F, Alberti M (2016) Qualitative risk assessment of a Dual Fuel (LNG-Diesel) system for heavy-duty trucks. *J Loss Prev Process Ind* 39:39–58. <https://doi.org/10.1016/j.jlp.2015.11.007>

# Optimal Thickness for Isolating Foams in Buildings



P. Arrué, A. C. Cárcel, A. M. Romero and C. Aparicio

**Abstract** In this paper the calculation methodology for obtaining optimal thickness of polymeric foams EPS, XPS and PU is developed, taking into account investment costs and operating costs in the construction elements, whose thermal transmittance limit is determined by the CTE (BOE, 2006). The use of a thicker insulating material produces a higher investment cost but the energy cost is less. This relationship allows determining the optimal thickness for a minimum total cost. The energy study is conducted with varying monthly temperatures for a reference location and for a period of 10 years. The optimal thickness of the insulating material associated to the minimum cost allows analyzing the influence of the enclosure type, façade orientation and insulating material type. These are the variables which have the most important influence on decision making in the resolution process of the constructive elements design. The study indicates that the insulating material type is the most influential variable in the optimal thickness. The second influential variable is the façade orientation and the third, the constructive solution for the analyzed cases.

**Keywords** Foams · Thermal isolation · Thermal transmittance Optimization · Costs

---

P. Arrué (✉) · A. M. Romero · C. Aparicio  
Dpto. de Construcciones Arquitectónicas, Universitat Politècnica de València,  
Camino de Vera S/N, 46.022, Valencia, Spain  
e-mail: paarbu@csa.upv.es

A. M. Romero  
e-mail: aromeros@csa.upv.es

C. Aparicio  
e-mail: caap@csa.upv.es

A. C. Cárcel  
ITM-DIMM, Dpto. de Ingeniería Mecánica y de Materiales,  
Universitat Politècnica de València, Camino de Vera S/N, 46.022, Valencia, Spain  
e-mail: acarcel@mcm.upv.es

## 1 Introduction

The energetic balance analysis of the construction element is performed in two types of façades and in two different orientations. The construction element is composed of different materials commonly used in construction, in which the type of thermal insulation will vary as well as its thickness, keeping the rest of the parameters constant, with the aim of analyzing their influence. The climate zone considered is that of Valencia City, classified as B3 in the CTE (BOE, 2006).

The costs analysis for the selection of an insulating material relates the investment cost of each type of material and the energy cost generated. This is because buildings require heating and/or air conditioning equipment to maintain the desired comfort conditions constant, generating energy expenditure. This energy cost is obtained from the heat flow through the enclosure in an annual period, calculated by using the program in transitional regime (TRNSYS) (Klein et al., 2004) and the electric energy costs, for the particular case that this type of energy was the power source of the calorific emission equipment used to provide the stable comfort conditions in the premises. The study is performed for a functioning time of 10 years and the equipment efficiency is considered to be 30% over the energy demand or the heat flow lost or gained.

## 2 Objectives

This study intends to determine the total cost of each type of material and enclosure in a study time of 10 years, allowing to determine the optimal thickness of each insulating material and the total minimum cost (Izquierdo et al. 2005). This allows analyzing the influence of the enclosure type, orientation, insulating material type and the cost ratio between the thermal energy and the electric energy cost. The results will influence decision making in the design process of the construction elements.

## 3 Methodology and Case Study

The study has been performed by considering the constructive solutions proposed in the CTE catalogue of construction elements (IETCC 2016). For this study, the F1.1. and F1.3. façades have been compared. These façades are made of brickwork without air chambers and with thermal insulation in the interior side. The difference between the two façade types is the inner sheet, which in the first one is built of hollow ceramic bricks with an interior lining made with plaster and paint, while in the second façade, it is made of laminated plaster panels and paint (see Fig. 1).



Code	Section (mm)	Input data		HS	HE
		HP	RM	GI	U (W/m <sup>2</sup> ·K)
F1.1		J1	N1	2	1/(0.54+R <sub>AT</sub> )
		J2	N2	3	
		-	B3	5	
F1.3		J1	N1	2	1/(0.42+R <sub>AT</sub> )
		J2	N2	3	
		-	B3	5	

Fig. 1 CTE construction elements catalogue. Façades F 1.1 and F 1.3

In this work, in each one of the façades six thermal insulators are used with different thickness. The considered thicknesses are comprised in a range from 0 to 12 cm in each constructive solution. Two totally opposed orientations are also considered (north and south) in order to assess if the orientation is decisive when choosing the insulating material (see Table 1).

Simulations have been made with the program in transitional regime TRNSYS. This program, in its application to buildings, complies with ASHRAE 140 and it can also be used to comply with ASHRAE 90.1, as well as the European directive on energy efficiency in buildings. It is also used to verify energy credits in the LEED certification process. In the program, a living area of 20 m<sup>2</sup>, for example, a living room, has been defined. The considered space has no holes, avoiding in this way solar gains and heat losses through façade holes. Once the façade is defined, as well as the climate zone (Valencia), the annual energy result per m<sup>2</sup> of constructed façade is obtained. This value is independent of the useful area of the considered premise. This allows extrapolating the result to any building with the same typology and to obtain conclusions about the influence of the type of enclosure, insulating material and orientation.

Table 1 Study variables

Study variables			
1	Façade types	F 1.1.	F 1.3
2	Orientation types	North	South
3	Thermal insulation types	EPS-1	EPS-2
		EPS-3	XPS-2
4	Insulating material thickness	PU-1	PU-2
5	Transmitted energy in the wall of the considered model (kWh/m <sup>2</sup> year)	From 0 to 120 mm	
6	Cost ratio between thermal energy and electric energy cost. Coef. = E <sub>thermal</sub> /E <sub>electric</sub>	Energy flow	
		Equipment performance coefficient 30%	

### 3.1 Investment Cost

The studied thermal insulating materials are closed cell polymeric foams such as expanded polystyrene (EPS-1, 2 and 3), extruded polystyrene (XPS-2) and polyurethane (PU-1 and PU-2) with the characteristics described in Table 2. These characteristics have been obtained from the supplier companies (Poliespor 2015; Ursa 2015; Poliuretanos 2015).

The investment cost corresponding to the thermal insulation per surface unit ( $C_i$ ) is obtained from the commercial material cost ( $C_a$ ) and the thickness of the different insulating materials under study ( $e_a$ ).

$$C_i = C_a \cdot e_a \quad (1)$$

It should be noted that not all materials have insulation panels with a variation of 1 cm; however, all thicknesses have been considered to obtain the optimal thickness and to verify if the commercial thickness is really the most economical and efficient.

The construction elements analyzed correspond to the brickwork façades, with the thermal insulation on the inside. There is a total of 17 façades in the CTE construction elements catalogue (IETCC 2016). Being the thermal transmittance ( $U$ ) a function of the thermal resistance of the enclosure without insulation ( $R_{sin}$ ) and of the thermal resistance of the insulation layer ( $R_a$ ):

$$U = \frac{1}{(R_{sin} - R_a)} \quad (2)$$

In the analyzed case, for façades F1.1 and F1.3 a thermal resistance value is set, without considering the thermal insulation ( $R_{sin}$ ) which has a value of 0.54 m<sup>2</sup>K/W and 0.42 m<sup>2</sup>K/W respectively, as indicated in Fig. 1.

The CTE in its Basic Document on Energy Saving, in Requirement HE-1 establishes that the maximum thermal transmittance for the façade ( $U_{max}$ ) in the B climate zone of Valencia is 1 W/m<sup>2</sup>K and a wall limit transmittance ( $U_{M \text{ lim}}$ ) of 0.82 W/m<sup>2</sup>K.

**Table 2** Insulating materials

Materials	Specific weight $\gamma$ (kp/m <sup>3</sup> )	Cost $C_a$ (€/m <sup>3</sup> )	Thermal conductivity $\lambda$ (W/m K)
EPS-1 Type III	15	27	0.039
EPS-2 Type IV	20	31	0.036
EPS-3 Type V	25	37	0.035
XPS-2 Wallmate IB-A	30	291.66	0.035
PU-1 D-40	16	207.59	0.023
PU-2 D-70	47	375.95	0.021

**Table 3** Minimum thickness of the insulation  $e_a$  min (mm) in the climatic zone B3 in façades F1.1 to F1.17 according to the insulating material used

Façade	EPS-1	EPS-2	EPS-3	XPS-2	XPS-6	PU-1	PU-2
<i>F1.1</i>	26.50	24.46	23.78	23.78	23.10	15.63	14.27
F1.2	19.87	18.34	17.83	17.83	17.32	11.72	10.70
<i>F1.3</i>	31.18	28.78	27.98	27.98	27.18	18.39	16.79
F1.4	25.33	23.38	22.73	22.73	22.08	14.94	13.64
F1.5	19.87	18.34	17.83	17.83	17.32	11.72	10.70
F1.6	13.24	12.22	11.88	11.88	11.54	7.81	7.13
F1.7	24.94	23.02	22.38	22.38	21.74	14.71	13.43
F1.8	19.09	17.62	17.13	17.13	16.64	11.26	10.28
F1.9	26.11	24.10	23.43	23.43	22.76	15.40	14.06
F1.10	19.48	17.98	17.48	17.48	16.98	11.49	10.49
F1.11	21.82	20.14	19.58	19.58	19.02	12.87	11.75
F1.12	30.79	28.42	27.63	27.63	26.84	18.16	16.58
F1.13	24.94	23.02	22.38	22.38	21.74	14.71	13.43
F1.14	31.57	29.14	28.33	28.33	27.52	18.62	17.00
F1.15	24.94	23.02	22.38	22.38	21.74	14.71	13.43
F1.16	33.91	31.30	30.43	30.43	29.56	20.00	18.26
F1.17	28.06	25.90	25.18	25.18	24.46	16.55	15.11
Maximum	33.91	31.30	30.43	30.43	29.56	20.00	18.26
Minimum	13.24	12.22	11.88	11.88	11.54	7.81	7.13

From the limit wall transmittance, being this the more restrictive value, the minimum insulation thickness ( $e_{a\min}$ ) needed for the different insulating materials used, is obtained. This value determines a minimum validity for the optimal thickness obtained through the development of this work.

The results are obtained with Eq. (3).

$$e_{a\min} = \left[ \frac{1}{U_{M\lim}} - R_{\sin} \right] \cdot \lambda_a \quad (3)$$

Of course, this value is a function of the thermal conductivity ( $\lambda_a$ ) of the considered thermal insulation. In Table 3, the minimal thickness of the thermal insulation for each one of the solutions in the catalogue, with the thermal insulations considered, are summarized.

### 3.2 Energy Transmitted Through the Enclosure

The energy transmitted through the wall has been quantified using the TRNSYS program. The annual transferred energy through the construction element has been obtained for each type of enclosure analyzed (F1.1 and F1.3), orientation (north and

south) and thermal insulation (EPS-1, EPS-2, EPS-3, XPS-2, PU-1 and PU-2) with the variation of the insulation thickness.

The model definition in TRNSYS has been performed considering a heated volume of  $6 \times 6$  m in plant view and 3 meters high. All the enclosures of this volume are opaque, this way avoiding the solar thermal gains, and all have been considered adiabatic, except one exterior enclosure. The interior comfort conditions for summer and winter are established according to the CTE HE-4 Appendix for residential use with a low internal source. The exterior temperatures and the meteorological data considered have been obtained from the climatic database (Meteonorm 2007) (Table 4).

The daily operating time is 24 h.

The energy analysis gives the energy annually gained or lost through a wall. This energy is obtained per surface unit for each one of the study cases and modeled equations are obtained of the consumed energy as a function of the insulating material thickness.

In Fig. 2, the energy data obtained is summarized. This is the energy which goes through the wall according to the constructive type selected and the thermal insulation thickness. In this summary, it is highlighted that the thermal flow varies according to the orientation. With the increase of the thermal insulation thickness, the energy through the wall is very similar for both orientations, regardless of the constructive solution.

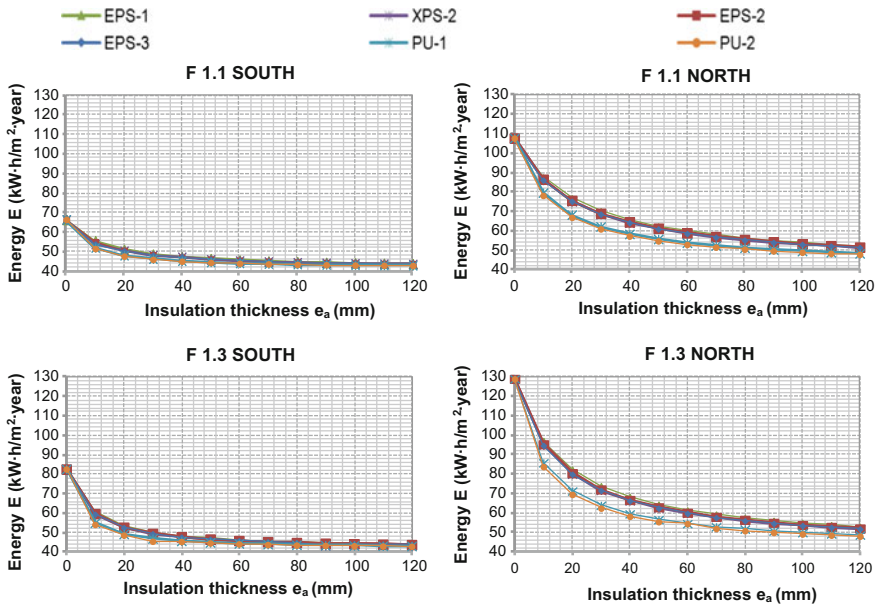
It should also be noted that the constructive solution has more importance when the thermal insulation is smaller, being higher the slope in the constructive solution F1.3 than in F1.1, both for south and for north orientations.

The mathematical modelling is performed for the annual energy results with regard to a thickness range of the insulating material between 0 and 120 mm, with polynomial equations of the fifth order, which present correlation coefficients higher than 98%. In Fig. 3, the polynomial equation is presented for the different façades and orientations, when the thermal insulating material used is EPS-1. This modelling is made for the different insulating materials analyzed.

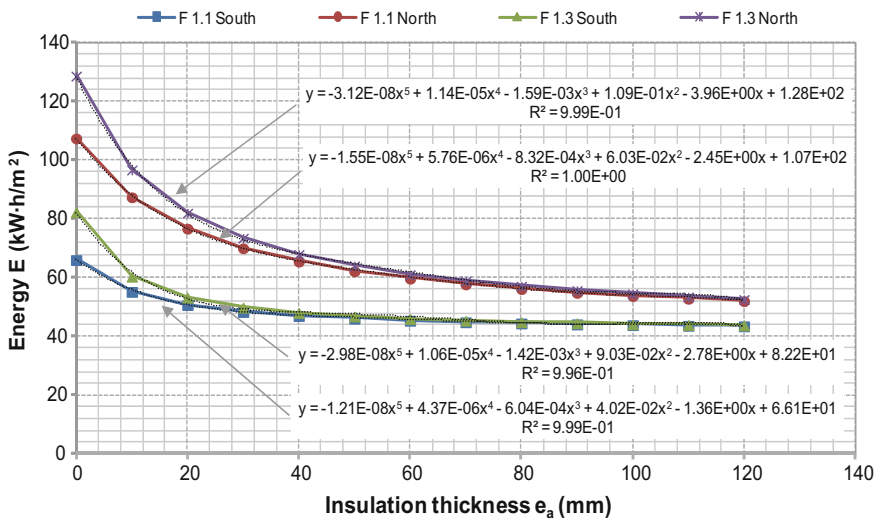
The energy flow through the wall presents a downward trend as the insulation thickness increases. This decline is very important for small thicknesses, but it is

**Table 4** Outdoor temperature in Valencia

Month	Indoor temperature (°C)	Outdoor temperature (°C)	Month	Indoor temperature (°C)	Outdoor temperature (°C)
January	20	10.97	July	23	24.42
February	20	11.62	August	23	24.94
March	20	13.58	September	23	22.42
April	20	15.02	October	20	18.81
May	20	18.41	November	20	14.31
June	23	21.23	December	20	11.83



**Fig. 2** Annual energy flow E (kW h/m<sup>2</sup> year) versus Insulation thickness e<sub>a</sub> (mm), according to façade type, orientation and insulation



**Fig. 3** Annual consumption E (kW h/m<sup>2</sup> year) versus Insulation thickness e<sub>a</sub> (mm). EPS-1

observed that for high thicknesses, the reduction of the energy that goes through the wall tend not to be significant. This implies that even if the thermal insulation thickness increases, the energy losses remain constant.

### 3.3 Total Cost

The result obtained with TRNSYS is the energy that goes through the wall, not considering the air conditioning equipment efficiency. If this information is to be related to the energy consumption cost, the performance factor has to be applied.

The total cost ( $C_t$ ) corresponds to the insulating material investment cost ( $C_i$ ) according to the used thickness and the operation energy cost ( $C_e$ ). This is equivalent to the energy consumption considering that the air conditioning equipment efficiency is 30%. In addition, the time of study is 10 years.

The total cost per surface unit is given by Eq. (4):

$$C_t = C_i + C_e \quad (4)$$

### 3.4 Optimal Thickness of the Insulating Material

To determine the optimal thickness, the most used calculation method is based on the application of the net present value NPV (Iglesias 2014). In this case, for each insulation investment the net present value of the given energy savings must be determined. It then must be compared with the increase that the investment entails. To determine the NPV, the multiplier coefficient must be applied (Eq. 5) which updates the savings in the total period considered.

$$\text{Coef} \cdot \text{NPV} = \frac{(m^t - 1)}{m - 1} \quad (5)$$

$$m = \frac{1 + 0.01 \cdot b}{1 + 0.01 \cdot r} \quad (6)$$

For a study time  $t = 10$  years, a predictable increase of the energy cost is estimated  $b = 5\%$  and a net present rate equivalent to the bank interest, taxes and inflation deducted,  $r = 2\%$ , thus an NPV Coeff. of 11.77.

To each insulation thickness, specific energy losses and an associated investment cost will correspond. As thickness is increased, the energy losses decrease and the investment increases. If two consecutive thicknesses are considered, the difference in energy losses will have an economic value, which is updated with the NPV Coeff. for the studied period and an investment difference will also exist. The economic optimal thickness represents equilibrium. That is, when the increase of savings is equal to the increase of investment.

Equation (7) allows the calculation of the total cost for each insulation thickness.

$$C_t = C_a \cdot e_a + E_{\text{consumption}} \cdot \left( \frac{E_{\text{thermal}}}{E_{\text{electric}}} \right) \cdot T_E \cdot \text{Coef} \cdot \text{NPV} \quad (7)$$

The energy cost is the equivalent electric cost of the energy transmitted through the enclosure, taking into account the equipment performance. The electric rate ( $T_E$ ) is that of January 2016 of 0.195056 €/kWh, including the electricity tax (IMP) of 5.7% and the VAT 21%.

The results for the total cost of Eq. (7) according to each thickness have been modeled using Eq. (8) with values of  $R^2 > 0.99$  (Fig. 4).

$$C_t = a \cdot e_a^5 + b \cdot e_a^4 + c \cdot e_a^3 + d \cdot e_a^2 + e \cdot e_a + f \tag{8}$$

The direct calculation method (Andima 1990) allows finding the economic optimal thickness, by deriving Eq. (8) with respect to the insulating material thickness, Eq. (9).

$$\frac{\partial C_t}{\partial e_a} = 0 \tag{9}$$

Figures 5 and 6 show the evolution of the total cost presenting a minimum value of the optimal thickness for the insulating materials PU-2 and EPS-1 respectively in each one of the enclosures and orientations. This same study has been performed for the six insulating materials combined with two façade types and the two orientations.

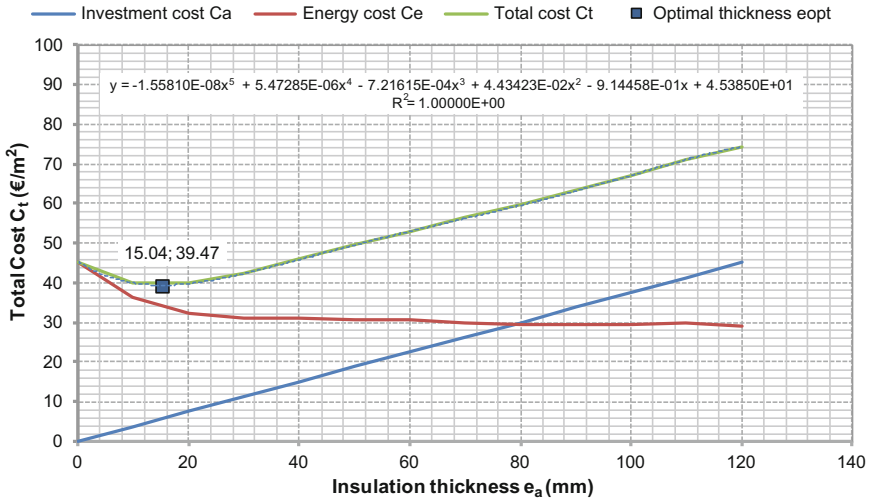


Fig. 4 Total cost  $C_t$  (€/m<sup>2</sup>) versus Insulation thickness  $e_a$  (mm) for  $t = 10$  years. PU-2. F1.1. South

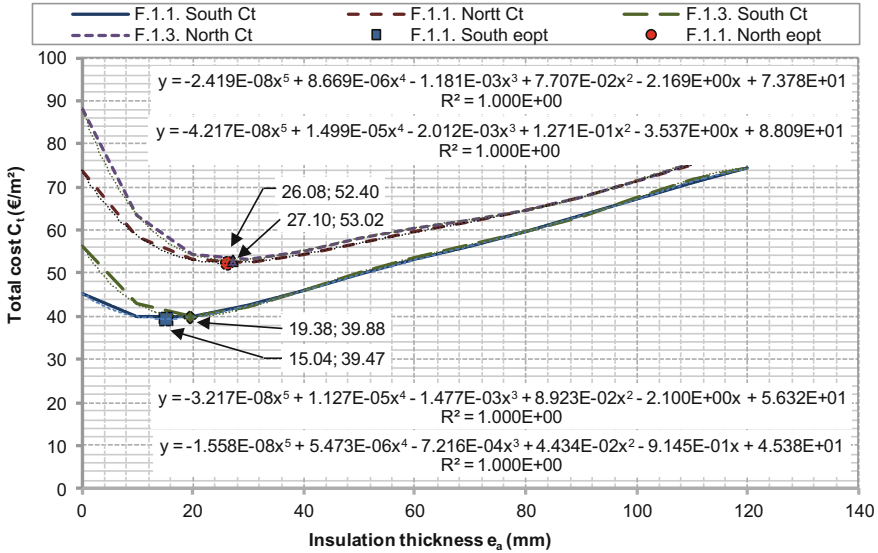


Fig. 5 Total cost  $C_t$  (€/m<sup>2</sup>) versus Insulation thickness  $e_a$  (mm) for  $t = 10$  years. PU-2

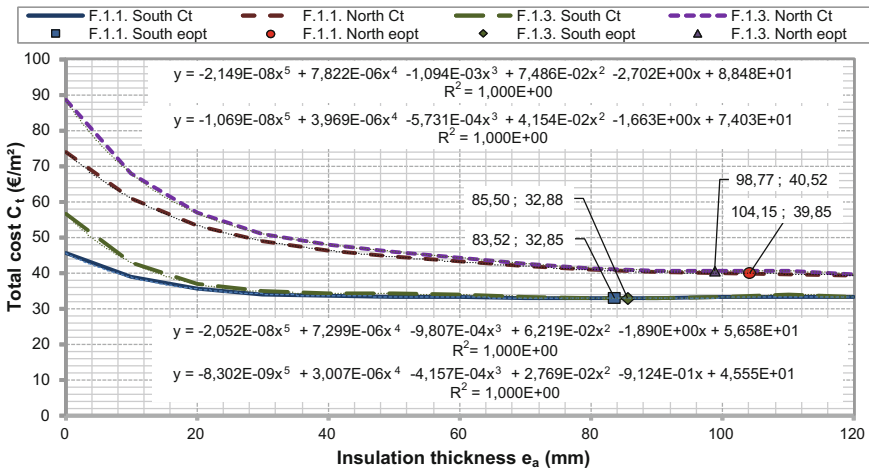


Fig. 6 Total cost  $C_t$  (€/m<sup>2</sup>) versus Insulation thickness  $e_a$  (mm) for  $t = 10$  years. EPS-1

### 4 Results

The results obtained for different materials, façades and orientations (optimal thickness versus minimum cost) are summarized in Table 5. The optimum thicknesses are between 15.04 mm (PU-2, F1.1 South) and 104.15 mm (EPS-1, F1.1



**Table 5** Optimal thickness  $e_{opt}$  (mm) and minimum cost  $C_{t\ min}$  (€/m<sup>2</sup>). Zone B3 and  $t = 10$  years

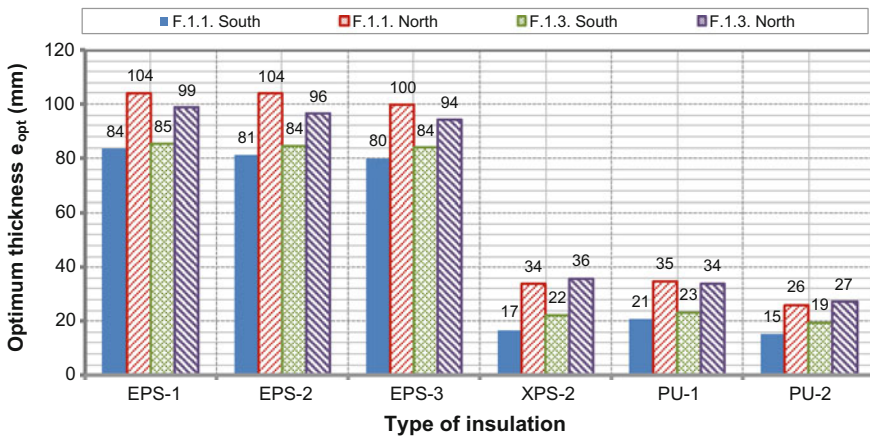
Façade	Parameter	EPS-1	EPS-2	EPS-3	XPS-2	PU-1	PU-2
F.1.1 South	$e_{opt}$ (mm)	83.52	81.21	80.05	16.79	20.67	15.04
	$C_{t\ min}$ (€/m <sup>2</sup> )	32.85	33.01	33.35	39.95	36.86	39.47
F.1.1 North	$e_{opt}$ (mm)	104.15	103.80	99.77	33.74	34.79	26.08
	$C_{t\ min}$ (€/m <sup>2</sup> )	39.85	39.76	40.21	55.58	48.33	52.40
F1.3 South	$e_{opt}$ (mm)	85.50	84.48	83.93	22.27	23.30	19.38
	$C_{t\ min}$ (€/m <sup>2</sup> )	32.88	33.00	33.24	41.34	36.98	39.88
F1.3 North	$e_{opt}$ (mm)	98.77	96.34	94.32	35.72	33.97	27.10
	$C_{t\ min}$ (€/m <sup>2</sup> )	40.52	40.26	40.56	57.12	49.04	53.02

North). In addition, the optimum cost is between 32.85 € (EPS-1, F1.1 South) and 57.12 € (XPS-2, F1.3 North).

### 4.1 Influence of the Insulation Type on the Optimum Thickness and Minimum Cost of Thermal Insulation

The material used as thermal insulator must be selected according with energy efficiency criteria. The insulating material thickness is important when the façade is being constructed, because the lower the thickness, the less dwelling surface will have to be occupied for its installation. In Fig. 7, the optimal thickness results are summarized, depending on the material, orientation and facade type. It can be graphically appreciated that the EPS insulation needs a greater thickness to obtain an optimal result.

In Fig. 8, the total cost is represented. This total cost is obtained according to the thermal insulation type, facade and orientation. In this case, the results are inverted



**Fig. 7** Optimal insulation thickness  $e_{opt}$  (mm)

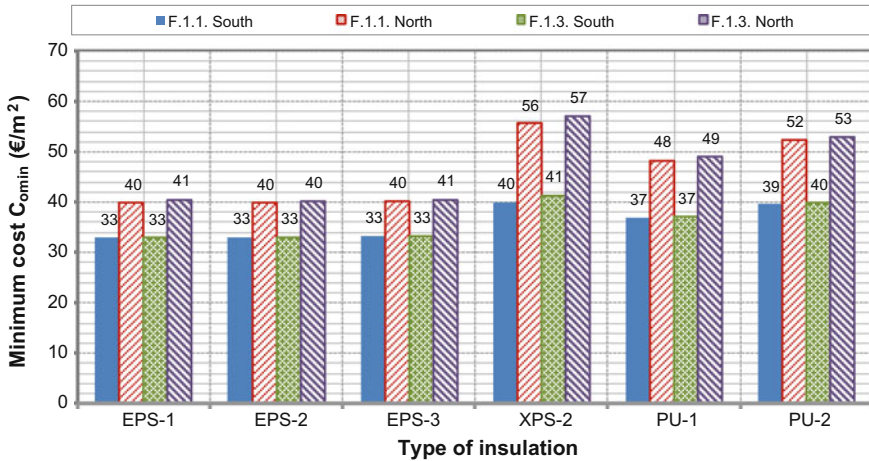


Fig. 8 Minimum cost  $C_t$  min ( $\text{€}/\text{m}^2$  año)

with regard to the prior graph. This is because EPS maximizes cost reduction, although this difference is lesser for south oriented façades and increases considerably with the north oriented façades, being XPS the most costly material.

The relationship has been obtained, between minimal total produced cost and the thermal resistance characteristic of each constructive solution. Results are shown in Fig. 9 and it is clearly seen that the XPS material is the most expensive and that EPS is less expensive, with regard to the insulation that they provide. In those cases, the orientation and constructive solution have more influence than with the other materials.

Optimal thickness variation with respect to the minimum value for a specific constructive solution and orientation, ranges from 264% to 455%, being EPS-1 the

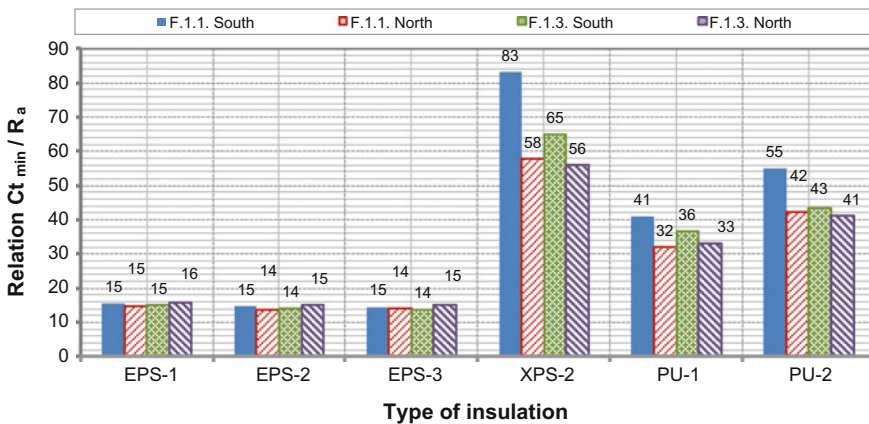


Fig. 9 Relation  $C_t$  min /  $R_a$  ( $e_{opt}/\lambda$ ) versus Type of insulation

**Table 6** Influence of the type of insulation material

Orientation	EPS-1	EPS-2	EPS-3	XPS-2	PU-1	PU-2	Variation
F1.1. South	84	81	80	17	21	15	455%
F1.1. North	104	104	100	34	35	26	299%
F1.3. South	85	84	84	22	23	19	341%
F1.3. North	99	96	94	36	34	27	264%

highest and PU-2 the lowest (Table 6). It should be noted, that greater variation exists in south oriented façades than in the north oriented façades. This is because the north oriented façades require higher insulation thickness. As it has been observed in Fig. 2, with higher thicknesses the declining tendency of the transmitted energy continues to decrease until it is no longer significant.

#### 4.2 Influence of the Façade Orientation on the Thermal Insulation Optimal Thickness

In the graphs, the difference according to the façade orientation is noticeable. This thickness variation with respect to the minimum value, ranges from 25 to 101% in F1.1, and from 12 to 60% in F1.3 (Table 7). The orientation has a greater influence than the constructive solution type. The south oriented façade has the best thermal behavior, less energy consumption and requires the lower insulation thickness.

**Table 7** Influence of the orientation of the façade

Orientation	EPS-1	EPS-2	EPS-3	XPS-2	PU-1	PU-2
F1.1. South	84	81	80	17	21	15
F1.1. North	104	104	100	34	35	26
<i>Variation</i>	25%	28%	25%	101%	68%	73%
F1.3. South	85	84	84	22	23	19
F1.3. North	99	96	94	36	34	27
<i>Variation</i>	16%	14%	12%	60%	46%	40%

**Table 8** Influence of the façade type

<b>Façade</b>	EPS-1	EPS-2	EPS-3	XPS-2	PU-1	PU-2
F1.1. South	84	81	80	17	21	15
F1.3. South	85	84	84	22	23	19
<i>Variation</i>	<i>2%</i>	<i>4%</i>	<i>5%</i>	<i>33%</i>	<i>13%</i>	<i>29%</i>
F1.1. North	104	104	100	34	35	26
F1.3. North	99	96	94	36	34	27
<i>Variation</i>	<i>5%</i>	<i>7%</i>	<i>5%</i>	<i>6%</i>	<i>2%</i>	<i>4%</i>

### 4.3 Influence of the Façade Type on the Optimum Thickness of Thermal Insulation

The façade type does not yield significant differences. The variation with regard to the minimum thickness range from 2 to 29% (South) and from 2 to 7% (North), Table 8.

## 5 Conclusions

The insulation thickness directly influences the interior comfort and the energy consumption required to achieve the comfort parameters. In this work, the heat flow through different enclosures has been analyzed, thus avoiding the need to introduce real dwelling models. Therefore, in this study, the insulation optimal thickness according to the material used, the constructive solution and the orientation are the parameters that have been taken into account.

The results show that investment in thermal insulation is important, because the decision on which material to use affects the investment costs, the thermal insulation optimal thickness and the energy consumption costs over the 10-year study time.

The thickness of the material to be used is the first analyzed factor in Fig. 4, and it is highlighted that the EPS requires the highest thickness of all analyzed materials. This is a very interesting finding, because it is crucial to reduce thickness in order to improve the useful surface of the space. The lower thicknesses have been achieved with PU-2.

However, when minimum cost is analyzed, according to the thermal insulation (used for the optimal thickness), it can be observed that the lowest cost corresponds to the EPS. This is due to the EPS' material cost, which is far lower than the rest of the insulating materials.

The insulation material type is the most important variable in the optimal thickness, because it shows the higher variability, from 264 to 455%. In second place, façade orientation is decisive to select the insulation material and its thickness, with variations from 12 to 101%. In all the results obtained, the thickness is always higher in the north oriented façade. And the third decision variable is the constructive solution for the analyzed cases (2–29%). The constructive solution F1.1 requires a higher investment than the rest of the façade solutions. This effect is considerably diminished by using EPS as the insulating material.

## References

- Andima (1990). El aislamiento en la industria y en la edificación: manual de consulta. Andima, ed., Madrid: Andima, D.L
- España. Real Decreto 314/2006, de 17 de marzo, por el que se aprueba el Código Técnico de la Edificación. Boletín Oficial del Estado, 28 de marzo de 2006, núm. 74, pp 11816–11831
- Poliespor. [Internet]. Soluciones Constructivas. consulted on January 16th, 2016. Available in: [http://www.poliespor.com/wp-content/uploads/2015/07/Poliespor\\_productos.pdf](http://www.poliespor.com/wp-content/uploads/2015/07/Poliespor_productos.pdf)
- Ursa. Productos. [Internet]. consulted on January 16th, 2016. Available in: <http://www.ursa.es/es-es/productos/ursa-xps/ursa-xps-rg/Paginas/informacion.aspx>
- Poliuretanos. Productos. Planchas y bloques. [Internet]. consulted on January 16th, 2016. Available in: <http://www.poliuretanos.com/productos/planchas/pur-d35.html>
- IETCC. Catálogo de Elementos Constructivos del CTE. consulted on April 13th, 2016. Available in: [http://www.codigotecnico.org/images/stories/pdf/aplicaciones/nCatalog\\_infoEConstr/CAT-EC-v06.3\\_marzo\\_10.pdf](http://www.codigotecnico.org/images/stories/pdf/aplicaciones/nCatalog_infoEConstr/CAT-EC-v06.3_marzo_10.pdf)
- Iglesias Placed C (2014). Estudio sobre posible amortización y cálculo de ahorro generado en la rehabilitación de la envolvente de edificios de viviendas mediante intervenciones bioclimáticas. 12º Congreso Nacional del Medio Ambiente, Madrid
- Izquierdo M, Gavira M, Lecuona J et al (2005) Espesor óptimo del aislante térmico para las viviendas de Madrid. In AMIET (ed) I Jornadas de Investigación en Construcción. Actas de las jornadas. Madrid: Instituto de las ciencias de la construcción Eduardo Torroja. CSIC., pp. 1175–1182
- Klein AA et al (2004) TRNSYS - A transient system simulation program-reference manual, solar Energy Laboratory, Version 17. University of Wisconsin-Madison, Madison, WI (USA). <http://sel.me.wisc.edu/trnsys/>
- Meteonorm, version 6.0 e handbook part I-software. 2007

# Evaluation of the Biomass Potential in the Region of Murcia (Spain): Application to Heat/Cooling Requirements in Industrial Parks (Energizing Life+)



A. Molina-García, J. M. Paredes-Parra, M. S. García-Cascales  
and J. Serrano

**Abstract** This article focuses on evaluating the potential of renewable energy generation in processes that demand heat/cold inside industrial areas in the Region of Murcia (South-eastern Spain). To this end, the application of solutions similar to those already implemented in the current European project, Energizing Life+, focusing on the use of biomass and photovoltaic generation is being studied in order to cover a high percentage of the energy demand of an industrial plant. In particular, this paper assesses the biomass and solar potential available in the surroundings of the industrial areas of the Region of Murcia, in order to evaluate the feasibility of the implantation of sustainable solutions in industrial areas and their impact on the CO<sub>2</sub> emissions of the Region of Murcia. This implementation is mainly focused on industrial processes that demand heat/cold, proposing the integration of absorption processes and thus linking the sources used with the final use of energy.

**Keywords** Renewable energy · Biomass · CO<sub>2</sub>

---

A. Molina-García (✉)

Dpto de Ingeniería Eléctrica, Universidad Politécnica de Cartagena,  
Murcia, Spain

e-mail: angel.molina@upct.es

J. M. Paredes-Parra · J. Serrano

Área de Energía Centro Tecnológico de la Energía y el Medioambiente CETENMA,  
Murcia, Spain

e-mail: jmparedes@cetenma.es

J. Serrano

e-mail: jorge.serrano@cetenma.es

M. S. García-Cascales

Dpto Electrónica Tecnología de Computadoras y Proyectos, Universidad Politécnica  
de Cartagena, Murcia, Spain

e-mail: socorro.garcia@upct.es

© Springer International Publishing AG, part of Springer Nature 2019

J. L. Ayuso Muñoz et al. (eds.), *Project Management and Engineering Research*,  
Lecture Notes in Management and Industrial Engineering,

[https://doi.org/10.1007/978-3-319-92273-7\\_16](https://doi.org/10.1007/978-3-319-92273-7_16)

## 1 Introduction

The ENERING project Enering Life+ (European Union 2011) funded by the European Union under the Life+ Program under reference LIFE-11-ENV-ES-542, supposes a demonstrative and real proposal of integration of renewable energy sources in industrial areas. Specifically, a pilot experiment has been carried out taking advantage of the existing solar and biomass resources in the area in order to reduce the electrical demand of the facilities of the Diego Zamora Group located in Cartagena (Murcia) (Serrano ET AL. 2015).

As adopted solutions, a 100 kWp photovoltaic solar system and an absorption refrigeration system have been implemented in order to supply the high climatization needs within the plant, where liquors with critical temperature requirements are manufactured and stored. The absorption system, with a total of 352 kW of cooling capacity, allows a reduction in the cooling needs of the cold maceration processes, when applying a pre-cooling to the product as well as air conditioning the processing rooms. The heat demanded by the absorption cycle is supplied by a 500 kW hot-water boiler fed with the biomass available in the area. This boiler is also responsible for powering the hot-water circuit required by the plant. These solutions cover around 60–70% of the demand for refrigeration, 100% of the heat demand and are from renewable energy.

In addition, demand reductions may even be more relevant in peak and summer months, coinciding with the period when the system is more productive with higher energy demands. In terms of CO<sub>2</sub> savings, and considering a CO<sub>2</sub> production of 0.523 kg/kWh, it is estimated that the proposed solution could save around 150 tonnes of CO<sub>2</sub>/year.

The main objective of this work is to evaluate the potential of substitution of the conventional energy sources by renewable energy sources in the industrial areas of the Region of Murcia (South-eastern Spain) applying similar solutions to those already implemented in the Enering Life+ Project, such as the use of biomass to obtain cold/heat and photovoltaic electricity generation in order to cover a high percentage of energy demand from industrial plants. For this purpose the available resources are evaluated for biomass and solar resource in the environment of industrial sites, in order to enable park and industry managers to evaluate the feasibility of the solutions proposed in the project and their impact on CO<sub>2</sub> emissions of the Region of Murcia. A previous study carried out by the authors in reference to the economic and environmental analysis of the integration of biomass in industrial estates can be consulted in (García-Cascales et al. 2015)

## 2 Energy Review of the Industrial Sector in the Region of Murcia

The energy consumption of industrial companies in the Region of Murcia reached € 328,793 thousand in 2013, with a rise of 2.51% compared to 2011, and 110% compared to 2001 according to the National Institute of Statistics (INE 2015). In

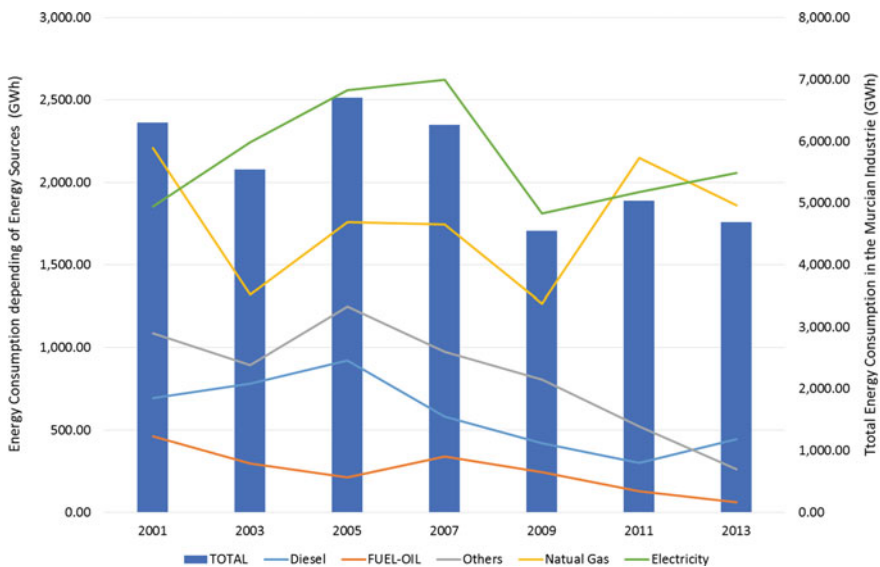
energy terms, the region’s industry had energy consumption in 2013 of 4,687.55 GWh, of which 2,629.55 GWh came from the consumption of Thermal Energy (LPG, Natural Gas, Diesel and Fuel-Oil), and (2,057.63 GWh) from Electric Power.

Analyzing the evolution of the last 12 years, in the period between 2001 and 2013, electricity has always been the main energy product, with percentages between 43.09% and 59.69% of the total. On the other hand, the percentage of consumption of petroleum products has gradually fallen to 11.17% of the total in 2013.

With regard to energy demand, it has increased by 110% in the last 12 years. Consumption of non-renewable energy sources has declined, reaching a 40% reduction compared to 2001 (see Fig. 1).

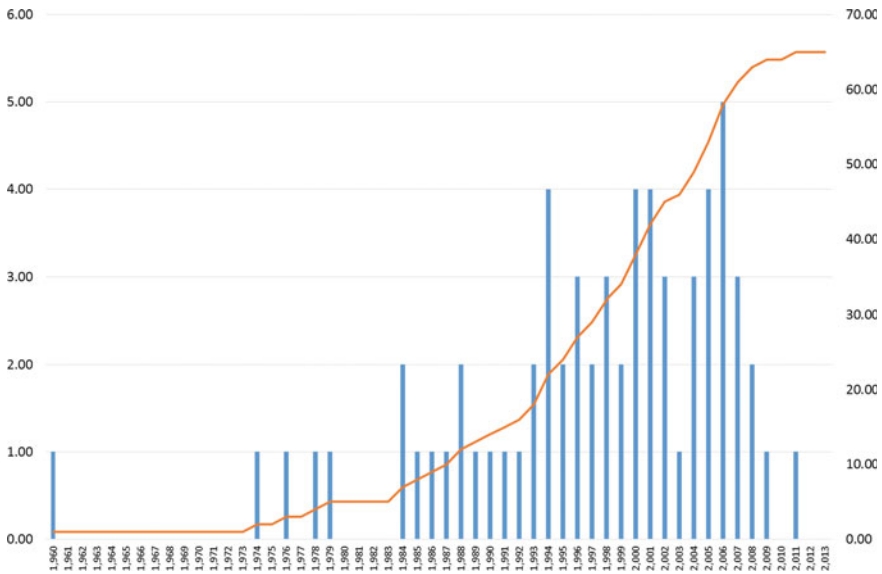
The increase in energy consumption suffered by the Region of Murcia is directly linked to the number of companies in the industrial sector that have been installed in the region over the last few years. In this sense, it is possible to establish a proportional relationship with the increase of zones or Industrial estates that have been constructed in order to house companies and industrial fabric in general.

Figure 2 shows the evolution of the number of industrial areas in the Region. At present the Region of Murcia has 64 Industrial Estates distributed throughout its geography, accommodating a total of 4977 companies. However, since 2009, the year in which the largest number of companies in the industrial sector was reached, the number of companies has fallen by 14% as a result of the financial crisis, reaching 8,728 companies in the industrial sector, according to The Regional Center of Statistics of Murcia (CREM 2013a, b) (Table 1).



**Fig. 1** Evolution of Energy Consumption in the Industrial sector, according to energy sources in the Region of Murcia. (CREM 2013a, b; IDAE 2014; INE 2015)





**Fig. 2** Evolution of the number of industrial estates in the Region of Murcia. *Source* Own elaboration based on data from (INFO 2015)

**Table 1** General information of industrial estates in the Region of Murcia

Numbers of industrial estates	Average occupation	Number of companies in industrial estates	Number of plots in industrial estates
64	66%	4,977	6,864

### 3 Evaluation and Development of Sustainable Biomass Resources and Supply Logistics in the Industrial Areas of the Region of Murcia

In order to estimate the potential of biomass available in the region of Murcia and its applicability as a renewable source in industrial estates, the BIORAISE tool has been used. This application is a GIS tool that provides information at municipal level in Spain on different crops for biomass production. Thus, it collects information on expected productions, economic, energy and environmental costs, including the collection and transportation of biomass from production sites to a chosen point of the national territory, providing technical support to farmers and the industry sector for the production of energy from solid biomass.

Because of the wide variety of agricultural biomass and existing sources, BIORAISE (see Fig. 3) employs a single method of application in general, so that agricultural sub-products are evaluated on the basis of the annual output of the main product. On the other hand, assessments of forest biomass are based on data provided by forest greenhouses.

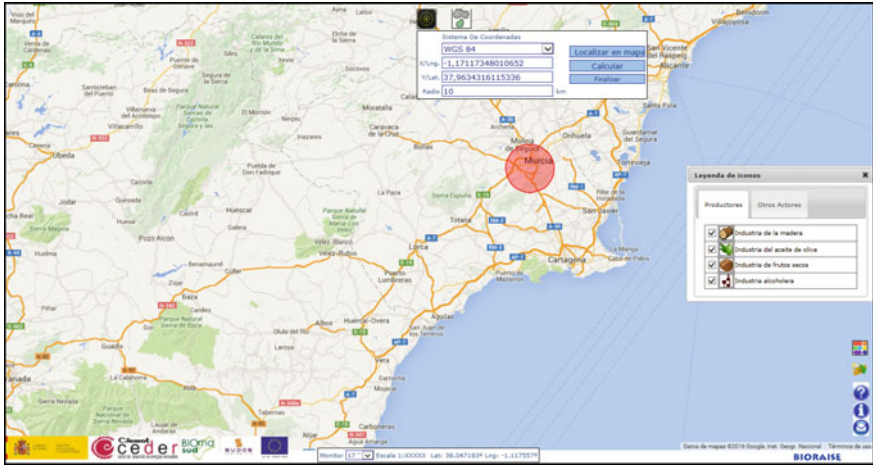


Fig. 3 Image of the BIORAISE tool

In this study, the energy assessment was carried out within a radius of 10 km of the industrial estate in question, located in Los Camachos (Cartagena), assessing the availability of biomass corresponding to the following crops: non-irrigated land, irrigated land, vineyards, fruit trees, olive groves and annual crops waste.

The results obtained in BIORAISE are shown in Fig. 4, where the Industrial Area of El Semollilla (Abanilla) and El Mojón (Beniel) present the greatest coverage of energy content, with the area of Los Prados (Cieza) being the least.

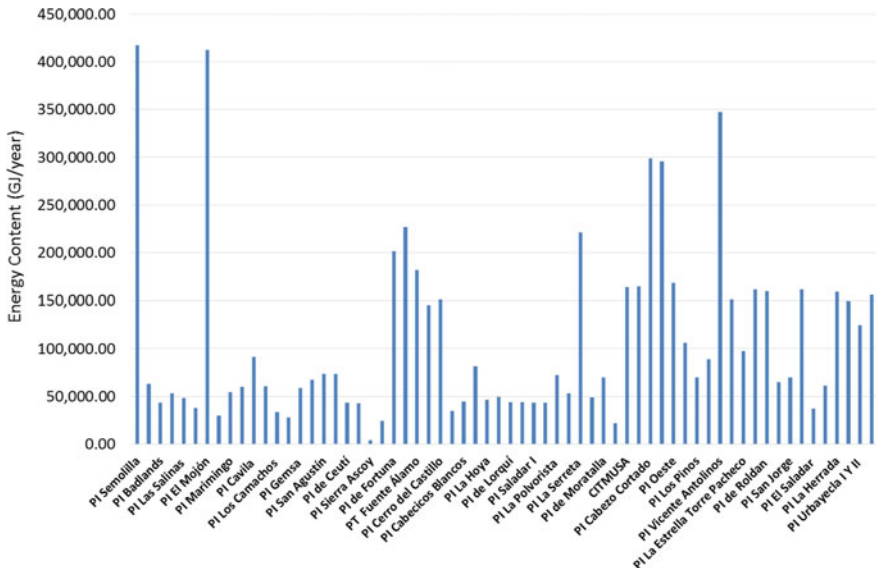


Fig. 4 Total Energy Content by Industrial Area. Source Own production based on data from BIORAISE (CIEMAT 2014)

**Table 2** Energy contribution of biomass in the Region of Murcia

Crop	Energy contribution (GWh)
Non-irrigated land	49.30
Irrigated land	169.71
Vineyards	282.70
Fruit trees	706.47
Olive groves	7.23
Annual crops waste	67.08

Source BIORAISE (EUROSTAT 2014)

In order to evaluate the energy production from existing crops in the Region of Murcia, the energy content of each of these crops will be taken into account. In this way, a total production of 561.09 GWh/year is reached. In Table 2, the energy contribution of the studied crops is shown.

#### 4 Estimation of the Potential for Solar Photovoltaic Generation in the Industrial Areas of the Region of Murcia

In order to estimate the potential for photovoltaic solar generation in the industrial areas, both on the roof and at the level of land in the Region of Murcia, different methodologies applied in similar studies have been evaluated within the available bibliography.

The applied methodology is divided into three levels: (i) Physical potential, corresponding to the amount of total energy received from the sun in the study area, (ii) Geographical potential, which limits the area where solar energy can be captured; and (iii) Technical potential, which takes into account the technical characteristics (including performance) of the equipment used for the transformation of the solar resource into electrical energy. In calculating the physical potential average Global values are obtained for irradiation, in the annual horizontal plane ( $\text{Wh}/\text{m}^2\text{day}$ ), monthly, and for each municipal area where the industrial estates are located. The database used is PVGIS (2012). Figure 5 shows the average annual global irradiation, in the horizontal plane ( $\text{Wh}/\text{m}^2\text{day}$ ), for each municipality of the Region of Murcia. The Region of Murcia has great physical potential, with an average solar radiation, in the horizontal plane, in the order of  $4,653.78 \text{ Wh}/\text{m}^2\text{day}$ .

The geographical potential of a renewable energy source is normally determined by the existing physical area, excluding areas reserved for other uses, such as roads, rivers, lakes, beaches and their areas of influence, in addition to protected areas such as National Parks. It was therefore based on the calculation methodology developed by (Izquierdo et al. 2008).

In the present case—the determination of electricity generation by means of the solar resource in industrial areas—such exclusions are not significant or valid, since

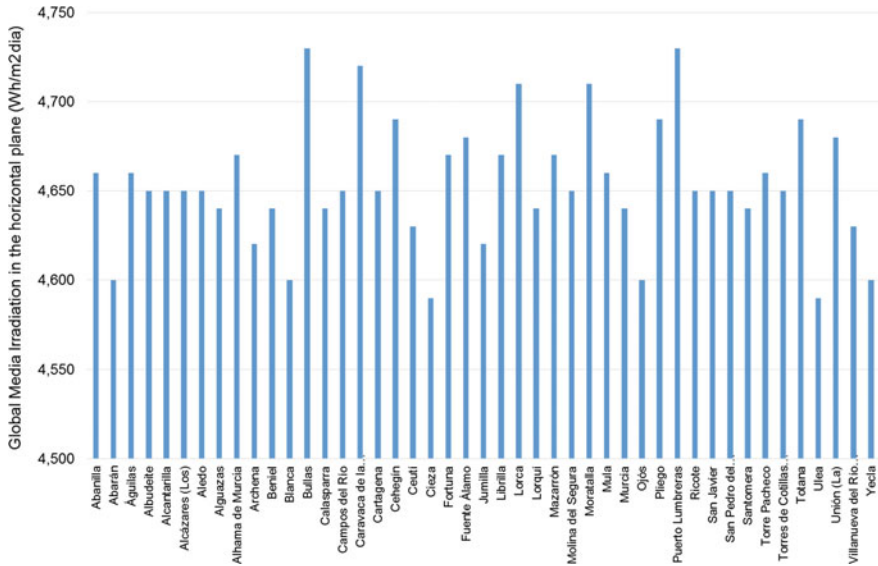


Fig. 5 Average Global Irradiation in the horizontal plane. Source PVGIS (2012)

Table 3 Summary of available surface areas for solar facilities in the Region of Murcia

Numbers of Industrial Estates	Areas (m <sup>2</sup> )					
	Total	Industrial	Green Zones	Equipment	Commercial	Roads
64	31,360,504	20,009,453	3,485,659	1,473,234	649,520	5,745,427

only the available cover area is important. However, other possible constraints are relevant due to the configuration of the estate and other industrial facilities, see Table 3.

In order to evaluate the available cover area this assessment starts with the Total Area of the Estate, the number of companies and plots and the occupancy level from which the constructed area (Aa) is calculated, which is the area occupied by buildings.

The area of roof or cover (A<sub>r</sub>) defined as the area within the floor area occupied by roof is calculated by estimating that 90% of the plot or industrial area belongs to the roof of the building based on this:

The available cover area is determined from the constructed area, applying the corresponding restrictions, by means of the following coefficients

$$Aa = A_r \cdot C_s \cdot C_f \cdot C_v \tag{1}$$

- Space fraction Coefficient (C<sub>v</sub>): This considers the space or gap in the buildings.

- Shadows Coefficient ( $C_s$ ): It takes into account the effects of shadows produced by other buildings, objects or by the actual configuration of the roof itself.
- Facilities Coefficient ( $C_f$ ): This excludes surfaces that have other applications (antennas, chimneys, air conditioners, etc.)
- The space fraction coefficient has been considered 0.58 that of shades 0.7 to value positively the low level of shade and 0.43 for the facilities coefficient that reflects.

With this data an available surface area for the installation of photovoltaic solar energy of 2,702,607 m<sup>2</sup> is obtained.

Finally, the technical potential is estimated. For this, three additional aspects must be taken into account:

- Radiation on sloping surfaces and determination of contributions of direct, diffuse and reflected (albedo) radiation.
- The need for space between photovoltaic modules to avoid shadows (especially, the criterion of minimum shading is applied in the winter solstice, the most unfavorable case, since the shadows are the longest).
- The efficiency of the photovoltaic module, which is a function, among other factors, of incident irradiance (W/m<sup>2</sup>) and ambient temperature (°C).

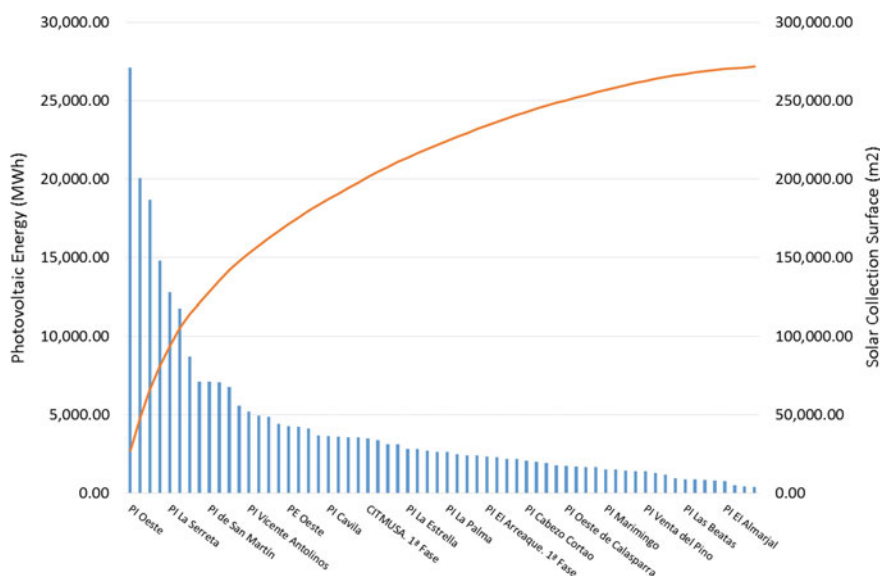
In this article, a fixed installation of 5kWp, with optimum orientation was used to determine the surface occupied by the installation, with a photovoltaic installation surface of 15 m<sup>2</sup>/kWp.

This same type of installation has been introduced into the PVGIS calculation tool (PVGIS 2012), thus calculating an annual kWh/m<sup>2</sup> of installation, considering for the calculations an average of 1500 kWh year/kWp installed. Based on the above data, the potential for electricity generation by means of the solar resource on the roofs of industrial estates of the region has been estimated, reaching a total production of 270.26 GWh/year. Figure 6 shows the production estimated by estate in the form of a Pareto diagram.

## 5 Estimation of the Potential for Saving of Emissions

In order to evaluate the potential for emission savings in the industrial sector of the Region of Murcia as a result of taking advantage of the energy sources studied in this document (solar photovoltaic and biomass), this assessment starts from the potential calculated in previous sections, a production of 561.09 GWh in the case of biomass and of 270.26 GWh in photovoltaic.

On the other hand, the current emissions of the sector from the consumption of the different sources employed have been estimated. For better accuracy in the calculation of the CO<sub>2</sub> emissions generated by fossil fuels in the production of thermal energy, an emission ratio has been calculated from the consumption of each of the calculated fuels, thus obtaining the values shown in Table 4. Table 5 below presents the emission savings derived from the implementation of these energy sources in the industries of the Region.



**Fig. 6** Pareto of potential of photovoltaic energy in the Industrial Estates of the Region of Murcia. *Source* Own elaboration

**Table 4** Emissions Ratio of Thermal Energy

	2005	2007	2009	2011	2013
EMISSIONS RATIO TE	241.13	228.20	228.75	238.06	245.42

*Source* Own elaboration

**Table 5** Potential of emission savings in the Industry of the Region of Murcia

	2005	2007	2009	2011	2013
Actual situation (TCO <sub>2</sub> )	2,019,643.20	1,877,650.82	1,349,825.87	1,512,317.05	1,466,348.35
Future situation (TCO <sub>2</sub> )	1,776,516.17	1,641,774.80	1,113,644.36	1,270,911.90	1,220,809.75
Emissions avoided (TCO <sub>2</sub> )	243,127.03	235,876.02	236,181.50	241,405.15	245,538.60
Reduction (%)	12.04%	12.56%	17.50%	15.96%	16.74%

*Source* Own elaboration

## 6 Conclusions

This paper aims to provide an estimation of the existing potential in the industrial areas of the Region of Murcia for energy solutions based on renewable energy sources present in the area, namely biomass and solar energy. This is based on the solutions proposed by the Enering Life+ project, which covers the needs of cold/heat and part of the rest of the electricity demand from these sources.

Based on the calculations made, the industry of the Region of Murcia could avoid generating up to 245,538.60 tons of CO<sub>2</sub>, which is a decrease of 16.74% taking 2013 as the reference year, by replacing current energy sources with other renewable energy sources that are readily available in the environment where the estates are located.

**Acknowledgements** This work was supported with funds from the European LIFE+ program by the project (LIFE-ENV-11-ES-542) and thanks go to all partners INFO, CETENMA, CTCON, COIIRM, UPCT project as well as the company DIEGO Zamora S.A.

## References

- Centro Investigaciones Energéticas, Medioambientales y Tecnológicas (CIEMAT) (2014) BIORAISE, Biocombustibles Sólidos de calidad en el sur de Europa. <http://bioraise.ciemat.es/Bioraise/main.aspx>
- Centro Regional de Estadística de Murcia (CREM) (2013a) Evolución del consumo de los principales hidrocarburos
- Centro Regional de Estadística de Murcia (CREM) (2013b) Evolución del número de establecimientos según actividad principal
- European Union (2011) Enering Life+ (<http://www.eneringlife.eu>)
- García-Cascales MS, Molina-García A, García-Sánchez T, Paredes JM (2015) Análisis económico y medioambiental de integración de biomasa en polígonos industriales: El proyecto Enering LIFE+ como caso práctico. 19 International congress on project management and engineering, Granada. (<http://www.aeipro.com/files/congresos/2015granada/05042.4460.pdf>)
- European Commission, Joint Research Centre Institute for Energy, Renewable Energy Unit (2012) Geographical Assessment of Solar Resource and Performance of Photovoltaic Technology PVGIS
- EUROSTAT (2014) Estadísticas Regionales de Superficie y Producciones Agrícolas. <http://ec.europa.eu/eurostat>
- Instituto de Diversificación y Ahorro Energético (IDAE) (2014) Balances de energía final (1990–2013)
- Instituto de Fomento de la Región de Murcia (INFO) (2015) Servicio Avanzado de Localización Industrial SALIN. <http://sueloindustrialmurcia.es/salininternet/>
- Instituto Nacional de Estadística (INE) (2015) Encuesta de Consumos Energéticos 2013
- Izquierdo S, Rodrigues M, Fueyo N (2008) A method for estimating the geographical distribution of the available roof surface area for large-scale photovoltaic energy-potential evaluations. *Sol Energy* 82:929–939
- Serrano J, Paredes JM, García-Cascales MS, Sánchez-Lozano JM, Molina-García A (2015) Potential study of biomass in the area of cartagena (Spain) under the ENERING LIFE + European Project. In: International conference on renewable energies and power quality (ICREPQ'15) La Coruña

# Financing Models for Sustainable Energy Communities in the United States of America



Romero-Rubio and Díaz De Andrés

**Abstract** Sustainable Energy Communities (SEC) are citizen groups that join together with a common goal: implementing renewable energies and/or energy efficiency measures, taking advantage, to the extent possible, of their local resources. These organizations adopt different financing models depending on several factors, such as legal context for renewable energy promotion, renewable technology, activity (production, supply, etc.), number of members, etc. Whereas incentives for renewable energy in Europe are traditionally based on grants, most of the federal incentives in the USA are based on tax reduction. To use these incentives efficiently, investors must comply with some conditions related to tax responsibility, type and level of income. Meeting these requirements is difficult for many individual investors willing to take part in an SEC. That is why, in the USA, several financing models for SECs aimed at overcoming this difficulty have been designed. These models have been very useful for the creation of a large number of SECs producing photovoltaic and wind energy. In this document, these financing models will be described, in order to analyze if they could be applied in Spain.

**Keywords** Sustainable energy communities · Financing models

## 1 Introduction

Sustainable Energy Communities (SEC) are citizen groups (e.g. farmers and live-stock breeders in rural areas, residential compound owners, etc.) that implement measures directed to efficient energy use and the implementation of renewable

---

Romero-Rubio · D. De Andrés (✉)

Área de Ingeniería de Proyectos, Dpto. de Expresión Gráfica, Diseño y Proyectos,  
Escuela Técnica Superior de Ingenieros Industriales, Universidad de Málaga,  
C/ Doctor Ortiz Ramos S/N, 29071 Málaga, Spain  
e-mail: jrandres@uma.es

Romero-Rubio

e-mail: romerorubioc@gmail.com



energies, trying always to take the maximum advantage possible of the available local resources (wind energy, solar energy, biomass, etc.)

Given that the citizens participate in the planning and commissioning of these measures, and even invest in them, SECs can improve public approval of renewable energies and energy efficiency, thus contributing to the compliance of energetic and environmental objectives (percentage of renewable resources being consumed or reduction of polluting emissions) and the development of energy distributed generation. For all these reasons, in general, both governments and international bodies in developed countries promote the creation of SECs.

The SECs adopt various legal forms and business models depending on various factors like geographic location, policy context (specially norms that regulate incentives fostering renewable energies), activities to develop (that would greatly condition the initial investment and the renewable technology to be used), number of users and property percentage, etc. (Romero-Rubio and Andrés-Díaz 2015).

In this work, various business models will be described that have emerged in the U.S.A, a reference country worldwide in the development of SECs.

In the United States of America, the normative to foster renewable power generation has greatly conditioned the design of the financing structures. They are very creative and adapted to incentives to renewables much less favorable than in many European countries, where these incentives have traditionally been based on subsidies.

However, in the U.S.A., most federal incentives available for renewable electricity producing installations are based on tax reduction from passive income. In order to efficiently benefit from these tax incentives, it is necessary for investors to have important tax obligations and sufficient passive income.

These conditions are not easy to meet for most citizens aiming to participate in a SEC. Furthermore, since dealing with tax incentives, these conditions are not applicable to tax free entities (e.g. cooperatives where 85% of their income comes from their members).

Financing structures for SECs in the U.S.A. are designed to overcome drawbacks and seize the full measure of these incentives. Furthermore, given that incentives have changed in the last decade, the financing structures have evolved accordingly. Largely thanks to these models, numerous SECs producers of wind and photovoltaic energy have been created in this country.

However, in Spain, a country with a vast variety of renewable resources where renewable energies have experienced an important growth in the past years, only a few isolated cases of SECs exist.

Most barriers for the creation of SECs in Spain are related to the regulations in the electric sector, especially since 2012, when all compensations for new installations were eliminated. These compensations had been established for the fostering of renewable electricity in the Special Status regulation.

Ever since, this regulation has evolved in a most unfavorable way for renewable electricity production facilities, drastically cutting back incentives for both new and existent installations (Romero Rubio 2016).

In this work, it will be analyzed under which conditions the financing models described for the SECs in the United States of America would be applicable in Spain in the actual context, aiming to accelerate the creation of SECs in this country.

## **2 Legal Framework for the Fostering of Renewable Energies in the United States of America**

In the United States of America, there is a great variety of programs for the fostering of Renewable Energy Sources (RES) and energy efficiency. These programs can be divided into two main categories:

- Regulatory policies (Rules, Regulations & Policies: RR&P): regulations mostly of an obligatory nature (although there also exist of a voluntary nature) aimed towards fulfilling energy efficiency goals or increasing the use of RES.
- Financial incentives: directed towards facilitating the financing of these projects, either through payments per kWh generated, loans, subsidies, reimbursement, discounts or tax reductions.

In turn, there are financial incentives and regulatory policies (directed towards fostering one or many technologies) at different territorial levels: federal, state, county, locality and even for utilities (companies in charge of generating, transporting, distributing and/or commercializing energy).

Furthermore, for a same territory (state, county or municipality) or utility, there can exist more than one type of financial incentive and/or regulatory policy.

On the database DSIRE (Database of State Incentives for Renewables & Efficiency), all financial incentives and regulatory policies that exist in the United States of America for renewable energies and energy efficiency are listed and described. This database can be accessed through the web page: <http://www.dsireusa.org/> (DSIRE 2016).

Among the great variety of existent programs to foster renewable energy, in this section those that have more importantly affected the creation of SECs have been described, and those useful for comparing the situation in the United States of America with that in Spain.

### ***2.1 Rules, Regulations & Policies: RR&P***

#### **2.1.1 Renewable Portfolio Standards (RPS)**

The RPS establish that a part of the electricity supplied by certain utilities or trading companies must proceed from renewable sources. In general, an RPS establishes a

minimum percentage generated through one or more technologies that must be reached by a certain date by the utilities/trading companies this case applies to (EIA 2012a).

Many states establish a Renewable Energy Credits (RECs) trading system in order to reduce the compliance costs of RPS. Every time 1 MWh of electricity is generated, an REC is likewise generated.

If a producer generates more renewable energy than needed to comply with the RPS, he can sell his RECs to other producers that have not been able to generate enough renewable energy to meet the minimum percentage established.

At present, no RPS program at federal level exists, but 29 states and Washington DC have mandatory RPSs. Moreover, 8 states have established voluntary objectives (RPG: Renewable Portfolio Goals). RPSs widely vary among states in structure, means of implementation, power limit of installations, renewable technologies, etc. (DSIRE 2016).

### 2.1.2 Net Metering

It is an electricity supply modality based on the compensation of energy balances, that allows consumers to produce energy for self-consumption and return to the network the excess generated in exchange for a credit on future electricity bills. This way, it is possible to use the excess of energy without the need to storage it.

If less than the necessary energy is produced, the missing energy will be imported from the network and the supplier will be paid.

If, on the contrary, more electricity than demanded is produced, the excess will be sent to the network and a credit is generated that will compensate in future bills with a maximum period of validity (EIA 2012b).

This supply modality applies in 44 States and in Washington DC. The implementation varies from state to state regarding renewable technologies, compensation of excess returned to the network, utilities forced to apply it to clients, property of RECs, etc. (DSIRE 2016)

The manner of implementation of Net Metering policies may help or hinder the development of SECs with self-consumption. The most influential aspects are (DOE SunShot Initiative 2012):

- Possibility of Virtual Net Metering: allows participants of collective energy projects to compensate their generated amount in the common plant of their residences (although, generally, the plant is not located inside the residence). Only 6 states allow it explicitly, others do not specify it and others straightforwardly prohibit it.
- Net metering caps: out of the 44 states with mandatory net metering, 29 put a limit on the total capacity installed. All new installations put into operation once the limit was reached, will not be able to invoke the net metering modality.

- Limits on the installed capacity or type of participants: if a condition to invoke the net metering modality is that the maximum power of the installations is 20 or 40 kW, is not easy for many SECs to be interested. Furthermore, some states allow less capacity to residential clients than other clients.

## 2.2 Financial Incentives

### 2.2.1 Renewable Energy Production Tax Credit (PTC)

During a plant’s first 10 years of operation, the PTC provides a tax credit per produced and sold kWh from a PTC beneficiary to a third party.

This credit varies depending on the technology. For example, in 2014, the credit for wind energy was \$0.023/kWh.

This incentive has been repeatedly cancelled and reinstated. The last time it was extended was at the end of 2015. First, it was planned to last until the end of 2014, but it has now been extended until 2019 (Bolinger 2014; DSIRE 2016).

Although the PTC is applied to various renewable technologies, it has become a key incentive for the development of wind energy in the United States of America, as shown in Fig. 1. Every time it has been cancelled, the added wind capacity for the given year has significantly decreased.

### 2.2.2 Business Energy Investment Tax Credit (ITC)

It allows owners of solar systems and other technologies to collect only one time, a tax credit equivalent to 30% of the investment (10% from 2022).

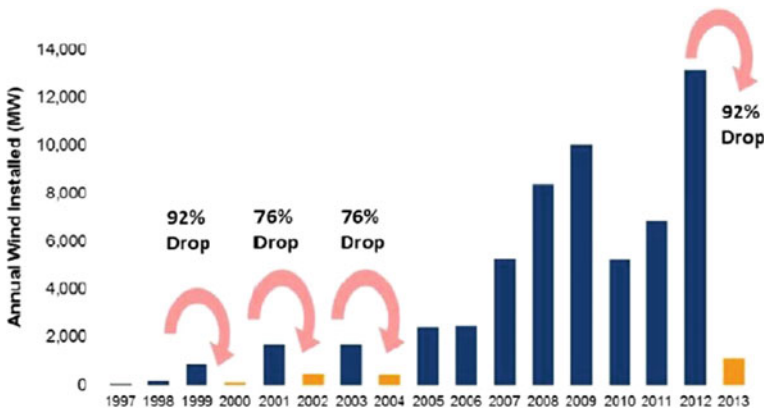


Fig. 1 Historical impact of PTC on the installed wind power. Source Simmons et al. 2015

The entire credit is collected on the first year, but it is linearly granted on the first 5 years. If the beneficiary sells the installation before 5 years, he must return the non-granted amount (Bolinger 2014; DSIRE 2016).

Contrary to the PTC, the beneficiary of the ITC has no obligation of selling to a third party the produced electricity, which allows business structures such as leasing.

It has historically been considered as the fiscal credit for solar projects.

### **2.2.3 Accelerated Depreciation**

Depreciation is an accounting concept used to reflect the loss of value of assets in time, taking into account the wear and tear factor. For tax purposes, most long-life assets depreciate with time, which is why depreciation itself is not a preferential tax incentive for renewable facilities.

However, accelerated depreciation allows owners of renewable facilities to reduce the depreciation period of their investment (from 20 to 5 years), obtaining a higher tax reduction during the first years of installation (Bolinger 2014).

At present, the accelerated depreciation according to the MACRS system is no longer in force since it expired at the end of 2014 (DSIRE 2016).

## **3 Business Models for SECs in the United States of America**

### ***3.1 SEC Producers of Wind Energy***

The definition of Community Wind Project (CWP) varies from author to author. For Bolinger, a CWP characterizes for the local participation (at least part of the investment proceeds from members of the local community), wind turbines at utility scale ( $P > 100$  kW), and the generated electricity is intended for self-consumption, for sale or both.

This definition refers to communities such as schools or agricultural areas, but does not include public utilities (Bolinger 2004).

However, the American Association of Wind Energy includes projects of less than 100 kW and projects property of public utilities.

When choosing a financing structure, the members of a CWP tend to choose the one that better adapts to the circumstances and characteristics of the project: state, income level of its members, applicable incentives, etc.

Given that wind projects require a high initial investment, business models are designed that make the most of available tax and state incentives, aiming towards reaching the expected investment return.

As incentives have changed in the last decade, business models have evolved so that two stages can be distinguished (Bolinger 2011):

- 1st stage: models oriented towards optimum exploitations of PTCs and accelerated depreciation.
- 2nd stage (approximately since 2010): new business models that make the most of normative changes that allow the participation of a higher number of investors/broaden the base of potential investors.

### 3.1.1 First Stage

New models arise to circumvent inconveniences presented by PTCs and accelerated depreciation for cooperatives and individual investors (Bolinger and Wiser 2006):

- They are based on federal tax reductions, so most of the cooperatives and public utilities cannot perceive them for they are exempted.
- For a maximum benefit, tax obligations must be important.
- Norms of passive activity, according to which PTCs and accelerated depreciation can only be compensated with taxes proceeding from passive income. There will only be considered as passive, rental income and businesses in which the taxpayer does not actively participate.
- In order to perceive the PTC, the entity must own the facility and sell the electricity to a third party, which excludes self-consumption and leasing type structures, plus forcing to obtain a long-term electricity sales contract.

On this stage, two basic business models are presented:

- Multiple Local Owner
- Flip Structures

#### Multiple Local Owner

One or more investors plan a common wind energy program and search for investors among the local community. They constitute an LLC (Limited Liability Company) in which investors can buy shares.

The LLC asks the local bank for a fiscal credit, or in some states, through a loan program destined to renewable energy. The LLC sells the electricity to a utility through a long-term electricity purchase contract (Bolinger 2004).

The investors share (proportional to the investment level):

- Obtained income
- Tax benefits (when able to perceive them)

Although it may seem simple, it has various disadvantages. In addition to the necessity of looking for investors with sufficient financial obligations and passive income to benefit from PTC and the accelerated depreciation, they must comply with normatives related to Securities, which rises prices and difficult the process even more.

### Flip Structures

One way of overcoming the difficulties many individual investors face in order to effectively benefit from PTC and the accelerated depreciation, is to associate with an investor with “tax appetite” that can easily absorb all tax credits. This is the base for the flip structure, of which a scheme is presented in Fig. 2.

A local and a strategic investor form an LLC. During the first 10 years of operation (period of implementation of PTC), the strategic investor possesses 99% of the LLC and benefits 99% from the financial incentives. The local one only has 1%.

After 10 years, the situation changes so that the strategic investor remains with 1% of the LLC and the local investor with a 99% of a wind project free of debts that can function for 10 or more years (Bolinger and Wisner 2006).

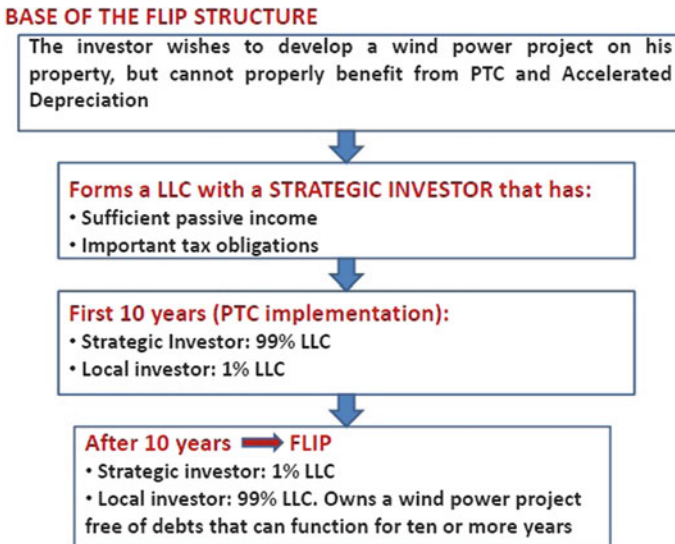


Fig. 2 Scheme of the flip structure. Source Own elaboration

### 3.1.2 Second Stage

Various normative changes were key to the development of new business models (Bolinger 2011):

- American Recovery and Reinvestment Act (2009). Wind energy projects can choose between PTC and ITC or 30% subsidy (“cash grant”), which allows:
  - The possibility of lease/saleback structures, since the ITC does not require for the beneficiary to be the owner of the facility nor it requires to sell the electricity to third parties.
  - ITC and “cash grant” are incentives based on investment and not production, which implies less malfunctioning risk.
  - “Cash grant” is a subsidy, which greatly reduces the need for fiscal responsibility of the owners.
- 2008 Farm Bill, section 6108. Allows the grant of loans to renewable generation projects nor proceeding from the rural environment.

## 3.2 CES Producers of Photovoltaic Solar Energy

A Community Shared Solar (CSS) facility produces electricity from solar energy and provides benefits to multiple members of the community. They present many advantages, among which are the following:

- They allow a great number of consumers access to solar energy.
- They offer scale economy to sponsors.
- They allow reducing the costs of solar energy incentive programs.

CSS business models are classified in two big groups (DOE SunShot Initiative 2012):

- Models promoted by utilities: A utility possesses and/or operates a project in which their clients can voluntarily participate.
- Special Purpose Entity (SPE) Models: A group of individuals constitutes a company to develop and finance a solar facility.
  - Self-Financing structures
  - Flip structures
  - Sale/Leaseback structures

### 3.2.1 Models Promoted by Utilities

For communities whose members wish to organize a “Community Shared Solar” project, the local utility can facilitate this task mostly because:



- Usually, utilities have the legal, financial and administrative infrastructure required to organize a CSS.
- Many utilities in the United States of America are governed by their own clients and can implement projects in name of their members (it is calculated that approximately one fourth of the American population owns their own electric company through electric cooperatives or public companies).

In most of the Utility-Sponsored projects, the clients of the utilities participate in a solar project by contributing with either a down payment or regular payment. In exchange, these clients receive a payment or credit on their electricity bills that would be proportional to their economical contribution and the amount of electricity produced by the solar facility (DOE SunShot Initiative 2012).

This way, the percentage of generated energy by each consumer is credited in their electricity bills as if they were self-consumption facilities located in their own residence or company. Thus, the possibility of applying the Virtual Net Metering is fundamental (Fig. 3).

Normally, the utility or a third party owns the facility and the participating clients have no shares on the project but they buy the rights to benefit from the produced energy.

### 3.2.2 Models for CSSs Structured as SPEs

In Fig. 4, the three types of SPE models are shown.

The Self-financing and Flip structures are similar to the Multiple Local Owner and Flip described for wind SECs but using ITC instead of PTC.

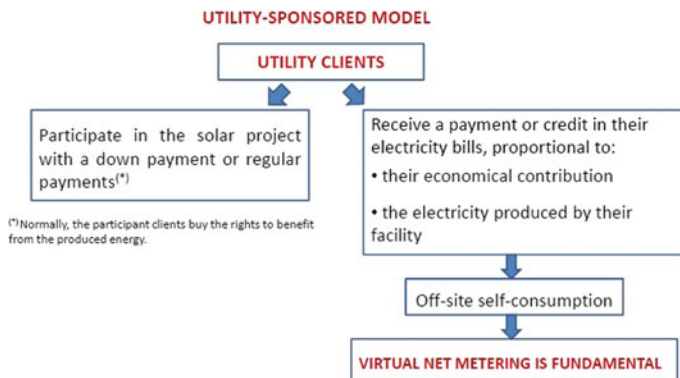


Fig. 3 Scheme of the utility-sponsored model. Source Own elaboration

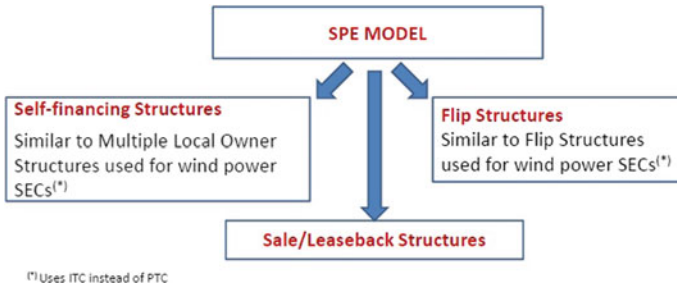


Fig. 4 Types of SPE models. Source own elaboration

### Sale/Leaseback Structures

In Fig. 5, a scheme of this structure is shown. The community SPE (as promotor of the project, owner of the land where it is located or both) installs a solar system, sells it to an investor and later rents it to this investor. As lessee, the SPE community is responsible for the operation and maintenance of the solar facility and has the right to sell or use the electricity.

In exchange, the lessee community pays regular fees to the fiscal investor (lessor). The benefits for the lessee community would be:

$$\text{Benefits} = \text{Electricity sale income} - \text{operational costs} - \text{facility rent.}$$

The investor has the right to use the fiscal incentives generated by the project and rent payments.

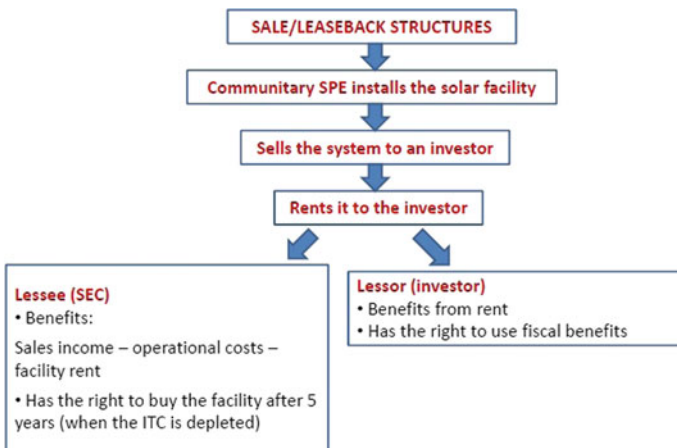


Fig. 5 Scheme of the sale/leaseback structure. Source Own elaboration

Once the fiscal benefits are exhausted (five years in the case of ITC) the communitarian SPE has the option of purchasing the facility (Romero Rubio 2016).

## 4 Discussion

In general, the existing financial incentives for the fostering of RES in the United States of America do not offer as much financial security as those applicable in Spain until 2012, nor are they easy to implement for groups of citizens aiming to invest in a collective matter in a renewable generation facility.

On the contrary, the federal fiscal incentives with which most of the wind and photovoltaic facilities have been financed (PTC, ITC and accelerated depreciation) are much more adequate for big corporations with important fiscal obligations and sufficient passive income to efficiently benefit from those incentives.

Some factors that have contributed to the development of SECs in the United States of America (in spite of not having, in general terms, favorable incentives for collective investments) are (Romero Rubio 2016):

- Existence of proven financing structures:

In the United States of America, citizens have searched for a way to collectively invest in renewable facilities, designing financing models that maximize applicable federal and state incentives to these facilities, in order to optimize their profitability and to meet expectations for return of investment.

Therefore, diverse strategies have been designed such as appealing to partners capable of efficiently utilize these incentives, searching for tax exemptions in laws related to securities, participating in programs promoted by the utilities (utility-sponsored models) or using sale/leaseback structures.

- Many utilities in the United States of America are governed by their own clients and can implement projects in the name of their members (it is calculated that approximately one fourth of the American population owns an electric company, either through electric cooperatives or public companies).
- 29 states establish mandatory RPS, which implies that many utilities are forced to meet the RPS objectives. The Community Shared Solar program organization, of the utility-sponsored type as described in Sect. 3.2.1, contributes for utilities to retain the RECs that will make them meet their RPS obligations.

In turn, these utility-sponsored programs facilitate the access of many citizens to renewable energies, even though they do not have especially high incomes or the installation of a renewable generation system may not be feasible, either because of lack of space, for living on rent, etc.

- The high degree of development of the net metering supply modality, even allows for the Virtual Net Metering variant explicitly in some states (including California, Delaware, Maine, Massachusetts, New Hampshire and Vermont). This modality allows participants of collective energy projects to subtract their own generation share off-site in their own residences.

## 5 Conclusions

In Spain as in the United States of America, the number of renewable energy generation facilities has significantly increased, just as the percentage of renewables in consumption, especially in the electric sector. However, contrary to the United States of America, the growth of renewables has not been accompanied by a significant increment in the number of SECs. In Spain, barely any organizations exist that can be considered SECs owners of producing facilities.

Moreover, since 2012, incentives for renewable electricity in Spain have drastically changed, cutting on retributions for new and existing facilities. The recent regulation for power self-consumption does not seem to create a favorable context either for investments on renewables with self-consumption.

For this reason, in the present article various business models used in the United States of America have been presented for collective investments of citizens adapted to incentives much less favorable than those applicable in Spain until 2012.

However, for these models to be applicable in Spain, a series of conditions are required:

- Modification of the Corporate Tax Law so that appealing fiscal incentives may be established for entities that invest in renewable power generation. Some of the possible measures would be:
  - increase the maximum depreciation straight-line coefficient for these facilities,
  - allow accelerated depreciation in investments superior to 10.000.000 € (limit of current investments in order to apply the accelerated depreciation),
  - establish incentives based on productions similar to PTC or investments similar to ITC, but without the limitations they present for small investors.
- Modification of the Royal Decree that regulates self-consumption so that Net Metering and the alternative Virtual Net Metering are allowed.
- Establishment of RPS programs that force electricity companies to meet certain supply objectives proceeding from renewable energy. The fostering of Utility-Sponsored projects as described for photovoltaic solar communities would contribute to the collection of RECs for meeting RPS obligations.

## References

- Bolinger M (2004) Making European-style community wind power development work in the US. *Renew Sustain Energy Rev* 9:556–575
- Bolinger M, Wiser R (2006) A comparative analysis of business structures suitable for farmer-owned wind power projects in the United States. *Energy Policy* 34:1750–1761
- Bolinger M (2011) Community wind: once again pushing the envelope of project finance. Lawrence Berkeley National Laboratory. LBNL-4193E. <http://emp.lbl.gov/sites/all/files/lbnl-4193e.pdf>
- Bolinger M (2014) An analysis of the costs, benefits, and implications of different approaches to capturing the value of renewable energy tax incentives. Lawrence Berkeley National Laboratory. LBNL-6610E. <http://emp.lbl.gov/sites/all/files/lbnl-6610e.pdf>
- DOE SunShot Initiative (US Department of Energy) (2012) A guide to community shared solar: utility, private and nonprofit project development. DOE/GO-102012-3569. <http://www.nrel.gov/docs/fy12osti/54570.pdf>
- DSIRE (Database of State Incentives for Renewables & Efficiency) (2016) <http://www.dsireusa.org/>
- EIA (US Energy Information Administration) (2012a) Today in Energy. Most States have Renewable Portfolio Standard. <http://www.eia.gov/todayinenergy/detail.cfm?id=4850>
- EIA (US Energy Information Administration) (2012b) Today in Energy. Policies for compensating behind-the-meter generation vary by State. <http://www.eia.gov/todayinenergy/detail.cfm?id=6190>
- Romero-Rubio C, Andrés-Díaz JR (2015) Sustainable energy communities: a study contrasting Spain and Germany. *Energy Policy* 85:397–409
- Romero Rubio C (2016) Barreras y oportunidades para las comunidades energéticas sostenibles en España: estudio comparativo con Estados Unidos y Alemania. (PhD Thesis, University of Málaga, 2016)
- Simmons RT, Yonk RM, Hansen ME (2015). The True Cost of Energy: Wind. Strata Policy. <http://www.strata.org/wp-content/uploads/2015/07/Full-Report-True-Cost-of-Wind1.pdf>

# Optimization of Large Offshore Wind Farms Implementation



**Bahamonde and Mena**

**Abstract** Presently, electricity production from wind energy contributes significantly to the energetic mix of some countries, being this type of renewable energy the most frequently implanted worldwide. At the end of 2015, the global total installed wind power was 432,419 MW, of which 11,551 MW were generated by offshore wind farms (GWEC, Global wind statistics 2015. Global Wind Energy Council, 2016). That year, 96 offshore wind farms were operating, 18 were under construction and dozens of facilities were approved. Furthermore, not only the number of offshore facilities is increasing, but their power capacity is increasing too. This situation demands the best orientation of the wind turbines alignment, so the wake effect produced in the rotors is reduced to avoid production losses. The aim of this work is to define criteria for the optimization of large offshore wind farms implementation in their design phase, based on geometrical arrangement of the wind turbines, so the wake effects are reduced to a minimum and, therefore, the electric power generation is maximized.

**Keywords** Wind energy · Offshore wind farms · Wake effect · Optimization

## 1 Introduction

Transition to offshore wind facilities have been made possible for some countries, due to wind-based energy generation onshore facilities saturation, the continental shelf's favorable conditions for the current technology, the acquired experience on open-sea oil and gas platforms and favorable government policies. These offshore

---

Bahamonde (✉) · Mena

Dpto. de Ingeniería Eléctrica y Térmica, de Diseño y Proyectos, Escuela Técnica Superior de Ingeniería, Universidad de Huelva, Campus de la Rábida, 21819 Palos de la Frontera, Huelva, Spain  
e-mail: bahamonde@uhu.es

Mena  
e-mail: mena@uhu.es

wind farms are concentrated mainly in the North Sea and the Baltic Sea. Thus, offshore wind energy generation holds a very promising future, despite its higher costs.

Figure 1 shows, in percentages, the distribution of the installed power range in offshore wind farms (OWF) in operation until the end of 2015. 31.2% of these facilities have a power output capacity of under 20 MW, being most of them demonstration projects. The rest, that is 68.8%, have a power output capacity equal or higher than 20 MW. This situation requires a more thorough study of the shortest distance between wind turbines and their alignment so the wake effect on their rotors is reduced. Among the wind farms with high power output, the most important projects are Greater Gabbard of 504 MW and London Array 1 with 630 MW, both in the United Kingdom; and the Danish project Anholt of 399.6 MW (4C Offshore 2015).

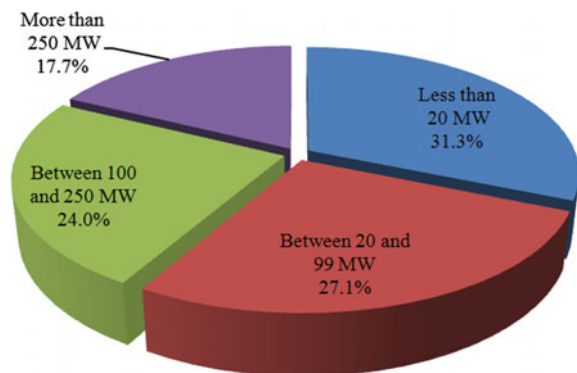
Regarding construction of OWFs, a total of 18 sites were identified until the end of 2015, so only 11.1% of these sites have a power output under 20 MW.

Generally speaking, a wind park does not produce the total energy than the isolated wind turbines would produce in favorable wind conditions (Manwell et al. 2009). The wind park losses are a function of: the spacing between wind turbines, the number and distribution of the wind turbines, the wind park size, the operation characteristics of the wind turbine, turbulence intensity, the distribution of the wind direction frequency.

In the OWFs, the wind turbines grouping design is used to maximize the number of turbines in a particular area, to minimize the park wake effect and to reduce visual impact. The environmental footprint of the wind turbines is smaller than that of other power production facilities, but it is important to highlight that their effects extend over a wide geographical area, with a wide zone of influence (Bishop and Miller 2008).

Accordingly, Esteban (2009) proposes a methodology for the implementation of OWFs following a comprehensive management line where technical, economic return and facility management aspects are considered, as well as their environmental compatibility.

**Fig. 1** Power distribution in offshore wind farms in operation



Regarding the technical aspects, the interference effect between wind turbines can become important, because they have increasing generation capabilities and, as a result, big rotors that collect wind energy. In OWFs, the wind turbines unit capacity is currently between 2 and 6 MW, and the rotors diameter is higher than 80 m, the initial demonstration projects being the exception.

In the reduced power OWFs with one or two wind turbines alignment, losses due to the park configuration are almost inexistent if an adequate geometrical arrangement is chosen based on the wind potential. However, in large wind parks with more than two alignments, a detailed study is needed, based on geometrical considerations according to the more energetic directions of the wind in the chosen site.

### 1.1 Energy Production Estimate in Offshore Conditions

Wind velocity profile in offshore conditions depends on the atmospheric stability of the superficial layer and the roughness of the sea surface, which is lower than the ground roughness but none the less it influences the friction velocity and thus conditions the wind estimate at the wind turbine’s hub altitude.

The precise determination of the wind resources for the implementation of OWFs requires in situ meteorological and oceanographic measurements. The usual way of obtaining them is to install measuring towers with sensors placed at different heights. However, a viable and economic alternative would be to use a network of buoys covering all the implementation area, equipped with measurement devices placed 10 m over sea level (o.s.l.) allowing treatment and height extrapolation.

Figure 2 shows a diagram for the calculation of the energy produced by a wind turbine. The input data are completed with the wind turbine characteristic curves provided by the manufacturer, which take into account, in the data processing, the atmospheric conditions variation and the sea surface roughness.

The output data are the calculations regarding the wind turbine rotor and the electric generator’s output energy. These calculations determine the functioning parameters, among which are the load factor and the number of equivalent hours.

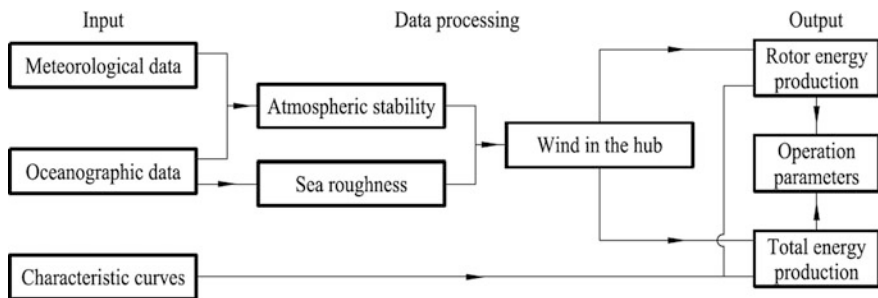


Fig. 2 Energy production diagram of an offshore wind turbine



### 1.2 Wind Turbines Wake

There are different types of models for the study of the simple and overlapping wakes in wind parks, reviewed by Crespo et al. (1999). In Table 1, the models most widely used in simulations are listed.

Kinematic models indicate in an a priori manner the shape of the wake profile and are based in simple wake diffusion laws. They only determine the wind velocity defect and do not use turbulence calculations (Crespo et al. 2010).

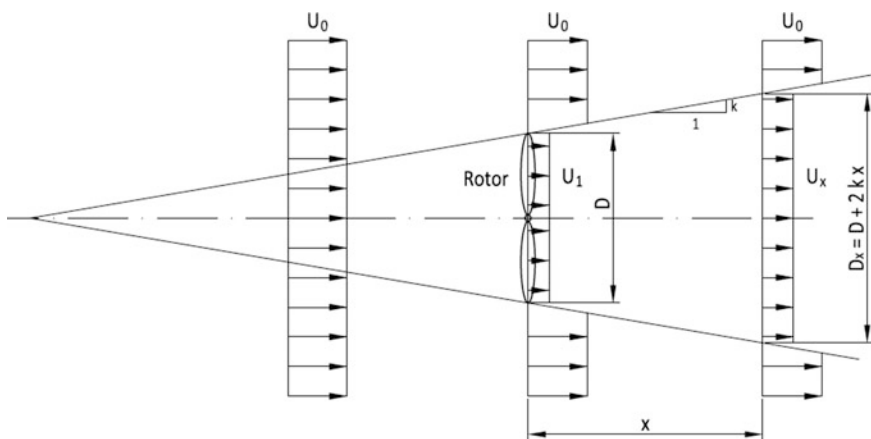
In Fig. 3, Jensen’s (1983) kinematic model is represented, adopted in the WAsP model (Wind Atlas Analysis and Application Programs). It is based on the wake linear expansion, so the wake decline by a constant  $k$  and it determines the downstream diameter increase rate.

According to the movement quantity conservation, the velocity deficit equation can be obtained as a function of a distance,  $x$ , downstream:

$$1 - \frac{U_x}{U_0} = \frac{(1 - \sqrt{1 - C_T})}{(1 + 2k \frac{x}{D})^2} \tag{1}$$

**Table 1** Wake model

Model	Type	Name	Institution (Country)
Analytic	Simple wake	Park	Risø (Denmark)
Analytic	Simple wake	MIUU	Uppsala University (Sweden)
Numeric 2D	Simple wake	Ainslie	Central Electricity Generating Board (United Kingdom)
Numeric 3D	Multiple wake	UPMwake	UPM (Spain)
Numeric 3D	Multiple wake	Wakefarm	ECN (Netherlands)



**Fig. 3** Jensen model wake representation

$C_T$  being the traction coefficient, which characterizes the thrust undergone by the wind turbine rotor, which curve is supplied by the manufacturer along with the power curves and the power coefficient.

The only empiric constant in this model is the wake decline,  $k$ , which is a function of multiple factors, including environmental turbulence intensity, turbulence induced in the rotor and atmospheric stability. The decline constants recommended for the WAsP model are 0.075 for onshore implementations and 0.05 for offshore implementations.

In OWFs where sea surface roughness and environmental turbulence are small, the wake effects can be relatively important (Crespo et al. 2010).

## 2 Objectives

The main objective of this communication is the design, on the project initial phase, of the spacing and alignment of the wind turbines in large OWFs so their energy production is optimized by reducing the wake effect of their rotors (Samorani 2013). This is done based on the available information in the data measurements which characterize the wind potential of an offshore site. Below, results obtained with the Gran Canaria buoy are analyzed. This buoy is part of the Puertos del Estado deep-water Buoy Network (REDEX).

This method's results allow for a first graphic estimate of the offshore wind farm project implementation, before other maximization criteria are applied. Its final configuration will not change ostensibly if the historical series of the wind energy from a reduced number of years is taken into account as a matter of priority. This historical series characterize its energy viability.

In the first part of this work, the shortest distance between wind turbines will be established based on the atmospheric stability conditions of the ocean superficial layer, which will be found at a distance of 6 to 10 rotor diameters (6D to 10D), although this theoretical limit will also depend on the power to be installed and on the area available for implementation.

In the second part, alignments will be determined, which will capture the highest wind energy, according to a square matrix. This square matrix can be extended to a rectangular matrix, as convenient forms in large offshore areas. Also the geometrical design can be modified by deforming the two basic forms and other geometrical shapes could be considered.

## 3 Methodology

Once meteorological and oceanographic data is measured with a buoy network in the implementation area for at least a year, the atmospheric stability conditions and the sea surface roughness are determined, and it is also possible to model the wind

variation at a wind turbine's hub height and the wind more energetic directions at this height.

In order to reduce the wake effect, a relationship will be established between the shortest required distance between two wind turbines and the stability conditions of the ocean boundary layer. The boundary layer is mainly neutral but it can vary depending on the geographical location. In addition to the atmospheric stability, other factors such as the total power capability to be installed in the wind farm and the available area for implementation will have to be taken into account. Then a minimal distance between six and ten rotor diameters (6D and 10D) will be established for the project as was decided in the initial study, based on the percentage atmospheric stability on site. Table 2 specifies a possible relationship.

Wind mass flow preservation through the wind turbine rotor diminishes its velocity once part of its energy has been extracted to configure the wake, which the next wind turbine will receive. Figure 4 shows the aligned interaction of a simple wake produced by the wind turbine  $A_1$  which receives unperturbed wind  $U_0$ , according to the Jensen model (1983). Behind the rotor, wind velocity has diminished to  $U_1$  and it begins to increase due to the contribution of the unperturbed wind with velocity  $U_0$ , when it travels the distance to wind turbine  $A_2$ , where the incoming wind velocity is  $U_2$ . In the wake detail, wind interactions are also shown when seen from above. This will be used for the large offshore wind farms implementation.

The used model is an approximation of the actual situation where a hypothetical current tube receives continuous contributions from the sea surface layer wind, in such a way that wakes (simple or multiple) are continuously fed of unperturbed wind in long distances. This ensures that the wind turbines of the last alignments continue functioning, although they contribute less energy than those of the first alignments, depending on the incident wind direction.

The second part of the method consists of establishing wind turbines alignments following a square matrix, which can be extended to other geometrical shapes, so the wake effect is minimized and thus, the energy production is maximized.

For description purposes, as input data, the implementation will follow a square matrix  $10 \times 10$  and the wind turbines will have a diameter of 90 m, D, with a minimum distance of six rotor diameters, 6D, and the most energetic wind direction is south. Figure 5 shows an implementation with an alignment such that the square side faces the most energetic wind direction, which is not the best orientation to maximize production.

Figure 6 shows a better alignment, with a square diagonal aligned with the most energetic wind direction.

**Table 2** Relationship between stability and distance amongst wind turbines

Neutral stability percentage	Distance expressed in rotor diameters (D)
Up to 70%	6D
Between 70 and 80%	7D to 8D
Between 80 and 90%	8D to 9D
Higher than 90%	9D to 10D

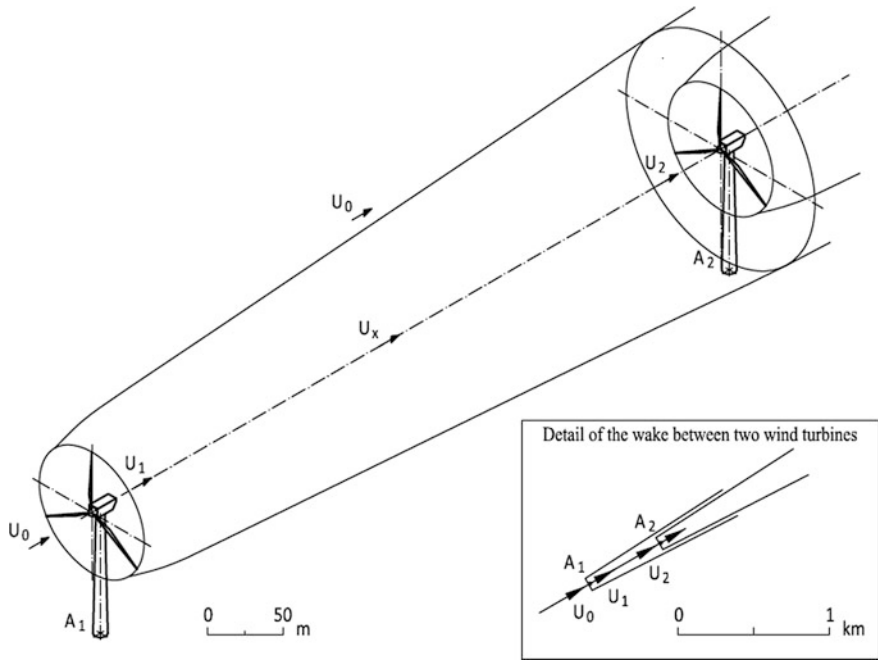


Fig. 4 Aligned interaction of a simple wake

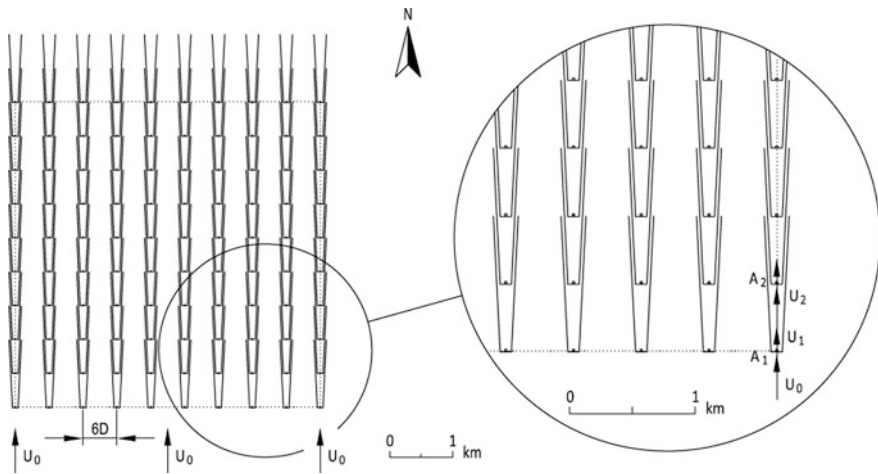


Fig. 5 Alignment along the side of a square matrix

This alignment increases to 19 the number of wind turbines that receive unperturbed wind,  $U_0$ , with the additional advantage that the distance between two wind turbines in the most energetic wind direction increases, being:

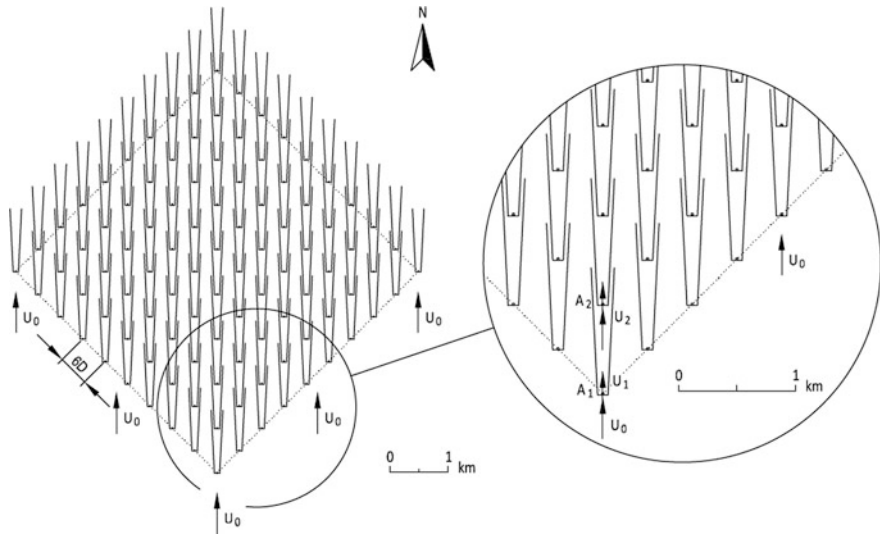


Fig. 6 Alignment along a square matrix diagonal

$$x = 6D\sqrt{2} \tag{2}$$

Thus, incident wind velocity in the second wind turbine rotor,  $A_2$ , according to the kinematic model described is:

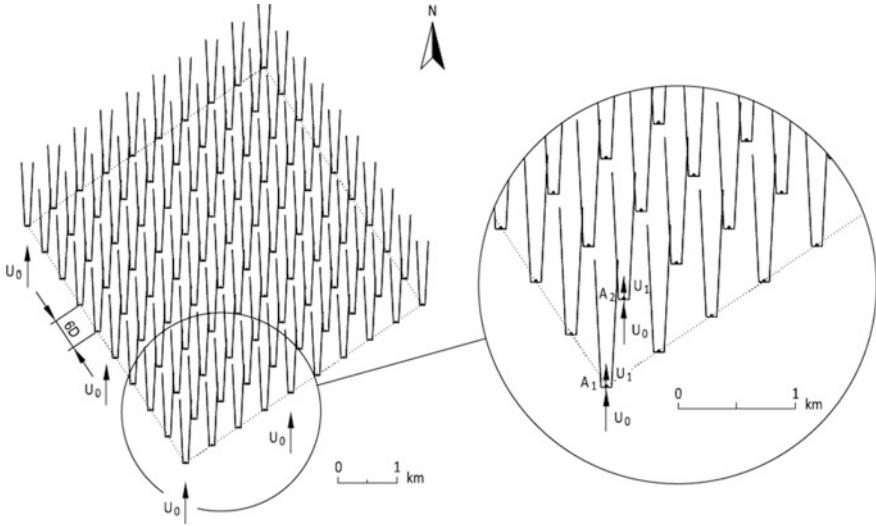
$$U_2 = U_0 \left[ 1 - \frac{(1 - \sqrt{1 - C_T})}{(1 + 12\sqrt{2}k)^2} \right] \tag{3}$$

With this reference, it is possible to optimize production when the diagonal in the sector ends becomes misaligned. It gives the central value the name wind rose with 16 directions, which in this explanatory case is south. Thus, in Fig. 7 the diagonal has a position of  $191.25^\circ$ , increasing the number of wind turbines which receive unperturbed wind,  $U_0$  and also increasing the distance between wind turbines aligned according to the incident wind, so the wake effect is diminished.

Thus, this method allows making a qualitative analysis of the best OWFs implementation, while in the design phase, based on the knowledge of atmospheric stability and the wind energetic distribution, from data measured in site.

#### 4 Results with REDEX Data, of the Gran Canaria Buoy

The Gran Canaria buoy ( $28^\circ 11.6' N$ ,  $15^\circ 48.4' W$ ), type Sea Watch, of the deep-water buoy exterior network (REDEX) of Puertos del Estado of the Ministerio de Fomento (Spanish Government), provides the meteorological and oceanographic hourly data required to present site results.



**Fig. 7** Misalignment in the diagonal direction

Also, the offshore wind turbine selected for the implementation is Vestas V90-3.0 MW, 90 m rotor diameter, with the hub 80 m over sea level.

Initially, the atmospheric stability is determined using the Richardson bulk number,  $Ri_B$ , given by the following equation:

$$Ri_B = \frac{g \cdot z \cdot (T_a - T_s)}{(273.15 + T_a) \cdot U_z^2} \tag{4}$$

being  $T_a$  the air temperature,  $T_s$  the sea surface temperature,  $g$  the gravitational acceleration,  $z$  the height over the sea level where the wind is measured, and  $U_z$  the wind velocity at that height. Depending on the obtained value, the following atmospheric stability estimations are made:

$$-0.01 \leq Ri_B \leq 0.01; \text{neutral atmosphere}$$

$$Ri_B < -0.01; \text{unstable atmosphere}$$

$$Ri_B > 0.01; \text{stable atmosphere}$$

Table 3 reviews the number of atmospheric stability cases of the superficial layer in the buoy site for a number of years, and it shows that neutral stability cases are the highest number of cases. Following the criteria proposed in Table 2, a minimum spacing of nine rotor diameters,  $9D$ , can be taken.

The next step is to determine the wind variation with height, knowing the atmospheric stability and the wind friction velocity due to the sea surface. The total wind’s energy density is then determined at 80 m over the sea level for each

direction for several years. These graphs are shown in Fig. 8. The sum of the energy density in each direction range determines the total energy density in each one of the 16 sectors. This way, it can be assessed that in this site the most energetic wind direction is NE (trade winds). The data effectiveness gives a measure of the valid data in each considered year.

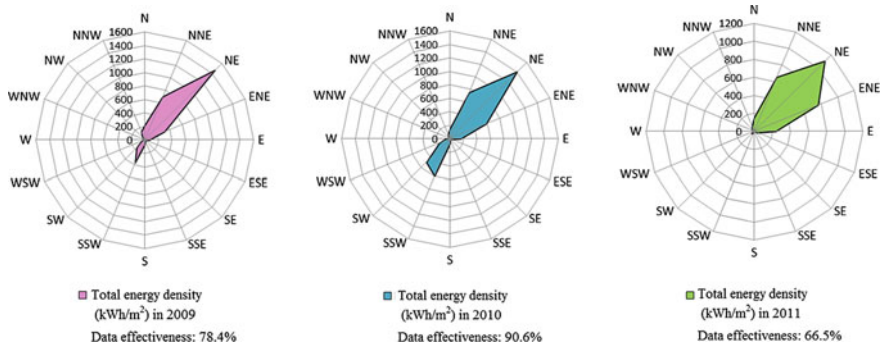
The Gran Canaria buoy data confirms that, in the absence of exceptional situations, the most wind energetic directions are systematically preserved.

Thus, as a first alternative, in Fig. 9 an implementation of  $10 \times 10$  V90-3.0 MW wind turbines with a diagonal in the Northeast direction (NE) is established.

In Fig. 10, a misalignment has been produced along the diagonal and it has been placed at the end of the central value sector NE, that is, at  $56.25^\circ$ . This way, an increase of the number of wind turbines that receive unperturbed wind,  $U_0$  can be achieved.

**Table 3** Atmospheric stability on site

Atmosphere	Year 2009		Year 2010		Year 2011	
	n	%	n	%	n	%
Neutral	6,212	90.30	6,778	85.44	5,288	90.83
Unstable	543	7.89	1,302	13.01	465	7.99
Stable	124	1.80	123	1.55	69	1.19
	6,879		7,933		5,822	



**Fig. 8** Wind energetic distribution at 80 m

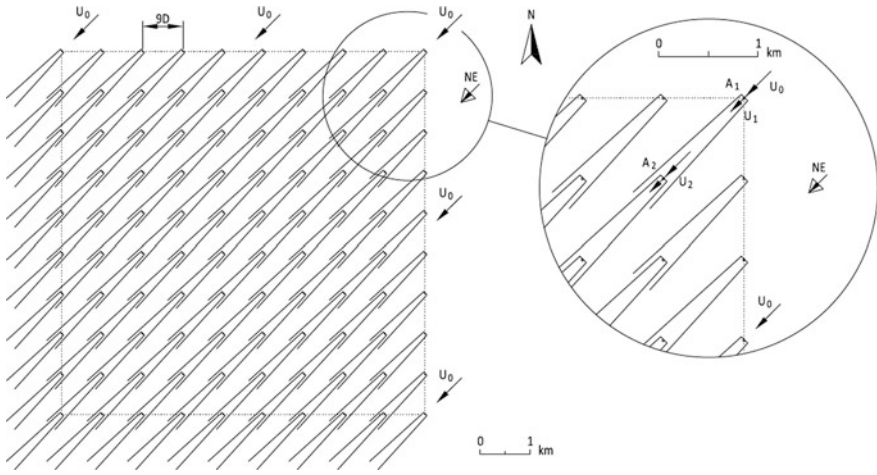


Fig. 9 Alignment along the diagonal in the Gran Canaria buoy placement

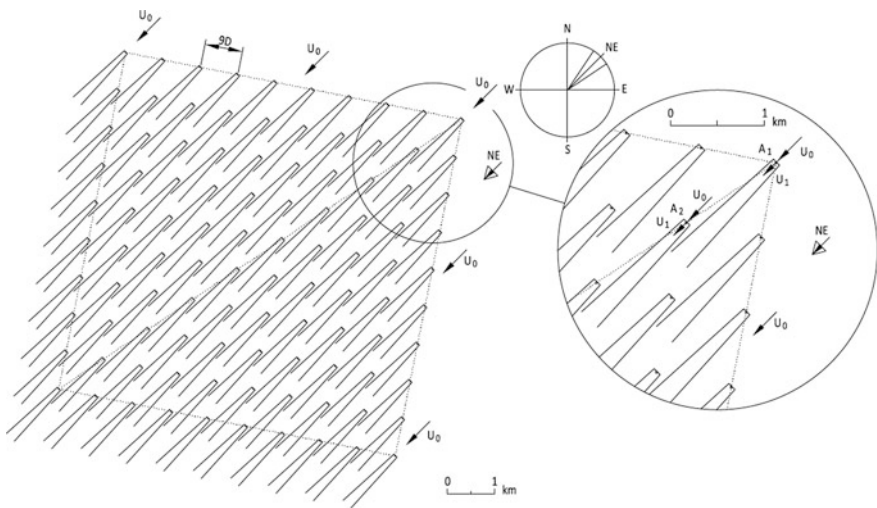


Fig. 10 Misalignment along the diagonal in the Gran Canaria buoy site



In Table 4, the energy density captured by two wind turbines aligned along the central value of the 16 directions in which the plane is divided (wind rose), is indicated. The first,  $A_1$  receives unperturbed wind  $U_0$  and the second;  $A_2$  receives wind according to the simple aligned wake  $U_2$  and, following the criteria of the studied model, is separated from the first one by:

$$x = 9D\sqrt{2} \tag{5}$$

This way, the information shown in Fig. 8 graphs is numerically verified, that is, that the wind direction which yields the larger energy production in the wind turbines is NE.

**Table 4** Overview of the energy captured by two wind turbines

Direction	Year 2009				Year 2010				Year 2011			
	Frequency		Energy density (kWh/m <sup>2</sup> )		Frequency		Energy density (kWh/m <sup>2</sup> )		Frequency		Energy density (kWh/m <sup>2</sup> )	
	n	%	A <sub>1</sub>	A <sub>2</sub>	n	%	A <sub>1</sub>	A <sub>2</sub>	n	%	A <sub>1</sub>	A <sub>2</sub>
N	535	7.8	211	158	471	5.9	147	109	328	5.6	149	113
NNE	1532	22.3	688	515	1565	19.7	739	563	1075	18.5	649	501
NE	2478	36.0	1455	1117	2400	30.3	1402	1088	1850	31.8	1095	839
ENE	666	9.7	318	242	1135	14.3	582	450	1420	24.4	767	583
E	256	3.7	78	58	421	5.3	161	125	501	8.6	231	175
ESE	96	1.4	34	25	135	1.7	27	21	110	1.9	40	30
SE	49	0.7	23	17	58	0.7	6	4	26	0.4	6	4
SSE	47	0.7	27	23	44	0.6	11	10	8	0.1	0	0
S	68	1.0	76	69	94	1.2	75	64	22	0.4	5	3
SSW	253	3.7	368	333	475	6.0	597	520	76	1.3	23	17
SW	235	3.4	165	138	458	5.8	493	430	84	1.4	36	29
WSW	115	1.7	47	39	165	2.1	170	151	53	0.9	26	22
W	40	0.6	11	9	88	1.1	64	57	25	0.4	6	5
WNW	44	0.6	20	17	59	0.7	20	17	18	0.3	14	12
NW	96	1.4	43	33	88	1.1	33	27	52	0.9	37	31
NNW	249	3.6	129	99	175	2.2	71	55	124	2.1	60	46
Calm	120	1.7	–	–	102	1.3	–	–	50	0.9	–	–
	6879				7933				5822			

## 5 Conclusions

An optimization model for large OWFs implementation has been presented, along with the most energetic wind distribution. This model takes into account the atmospheric stability conditions and the sea surface roughness. It maximizes the energy production of the wind turbine group, by minimizing the wake effect.

A square matrix has been adopted as the implementation model. This matrix can be extended to other geometrical shapes, so the shorter distance between rows and columns depends on the sea superficial layer atmospheric stability conditions, being this distance between six and ten rotor diameters (6D to 10D). However, this theoretical limit can change depending of the inherent requisites of the project, such as the power capability to be installed and the area available for the implementation.

The best orientation for the implementation of large OWFs with a predominant energetic direction is the one that misaligns one of the square matrix diagonals along the more energetic wind direction. This layout increases the number of wind turbines that receive unperturbed wind and also increases the distance between wind turbines.

## References

- Bishop ID, Miller DR (2008) Visual assessment of off-shore wind turbines: The influence of distance, contrast, movement and social variables. *Renew Energy* 32:814–831
- 4C Offshore (2015) <http://www.4coffshore.com/windfarms/>
- Crespo A, Hernández J, Frandsen S (1999) Survey of modelling methods for wind turbine wakes and wind farms. *Wind Energy* 2:1–24
- Crespo A, Migoya E, García J et al (2010) Efecto de las estelas en los parques eólicos. Ponencia en Congreso: Solar Decathlon Europe 2010. Madrid
- Esteban MD (2009) Propuesta de una metodología para la implantación de parques eólicos offshore. Tesis. Madrid: E.T.S. de Ingenieros de Caminos, Canales y Puertos
- GWEC (2016) Global wind statistics 2015. Global Wind Energy Council
- Jensen NO (1983) A note on wind generator interaction. Informe técnico. Roskilde, Dinamarca: Risø National Laboratory. Risø-M-2411.18 pp
- Manwell JF, McGowan JG, Rogers AL (2009) *Wind energy explained: theory, design and application*. 2<sup>a</sup> edición. Chichester (West Sussex): John Wiley & Sons Ltd
- Samorani M (2013) The wind farm layout optimization problem. In: Pardalos PM et al (eds) *Handbook of wind power systems*. Springer, Berlín, pp 21–38

# A Computational Study of the Aerodynamic Hiding Factor Between Panels' Arrays for the Optimization of Support Structures in Solar Parks



R. Escrivá-Pla and C. R. Sánchez-Carratalá

**Keywords** Photovoltaic solar plants · Support structures for panels  
Wind loads · Hiding between panels' arrays · Parallel computing  
Computational Fluid Dynamics

## 1 Introduction

The support structures for photovoltaic generation plants are, in general, very repetitive structures composed by steel or aluminum bars, which are very light and diaphanous; their height rarely exceeds 10 m over ground level and almost always their height is less than 5 m. For the most part, they are formed by one or two columns which support a flat matrix of lintels and straps, to which the photovoltaic modules or panels are attached. Depending on the conditions of location, construction, maintenance and production, the design may lead to propose fixed or mobile structures (this last type of structures is also known as trackers with one or two axes movement). In this communication, the case of fixed structures is addressed since it represents the predominant type of structures in large solar parks. This is due to their low costs during construction and exploitation. These cost reductions compensate for production losses derived from not following the sun in its trajectory during the day and throughout the different seasons.

Fixed structures can be founded using concrete footings supported or embedded in the ground, or through short piles—generally metallic, screwed or driven into the ground—(Sánchez-Carratalá 2012). Among the most important actions that the

---

R. Escrivá-Pla · C. R. Sánchez-Carratalá (✉)

Dpto. Mecánica de Medios Continuos y Teoría de Estructuras, E.T.S. Ingenieros de Caminos,  
Canales y Puertos, Universidad Politécnica de Valencia, Camino de Vera s/n, 46022  
Valencia, Spain  
e-mail: csanchez@mes.upv.es

R. Escrivá-Pla  
e-mail: raespl@cam.upv.es

structure has to be able to resist are the pressure (or suction) due to the wind, and the accumulation of snow or sand over the modules. With the wind acting in the direction of the sun rays, the typical failure mechanism is the collapse of the structure due to axial buckling of the columns or by a bending failure of the lintels or the straps of the framing. Also, the wind action can have an effect over the structure's global stability because it can lift the foundation, especially when it is acting in the opposite direction of the solar rays. Another structure failure mechanism when the wind is blowing from the panels' backside is due to an excessive bending deformation of the straps that produces a bar curvature such that the modules can break free from their fastening to the structure.

In professional practice, it is usual for the structural designer of photovoltaic parks, to be forced to adopt conservative hypotheses when considering the load said structures will have to withstand during their service life. These hypotheses lead to match the designed structure with cases of similar geometries which are included in the literature or in codes, adopting the corresponding values for the design loads.

The arrays or tables of photovoltaic panels are composed of installed generator modules united in the form of a matrix. They constitute one flat surface which is fixed to a single structure (more or less elongated). The wind applies most of its pressure over this surface which the support structure must withstand. Nowadays, to obtain the design loads that act over the surfaces of the panels arranged in a photovoltaic park, the planner commonly resorts to existing standards and recommendations, apart from possible physical tests at a reduced scale—wind tunnel—which are not frequent.

Within these standards, design values for the load due to the wind action are provided, based on the wind velocity on the site. For this end, pressure or surface force aerodynamic coefficients are used (e.g., Comité Técnico AEN/CTN-140 2005; Puertos del Estado 1995; Dirección General de Carreteras 2011). To determine these coefficients, normally a series of typical geometries is established—which are parameterized idealizations of the most frequent use cases—, over which analytic and/or experimental studies have been performed (Tomás and Morales 2012). The hiding effect produced by the wind action is considered in standards, either implicitly through cases of particular geometries where this effect is produced (e.g., sawtooth roofs), or explicitly, through the general treatment of a structural typology (e.g., lattices), using geometric parameters (separation, height, exposed surface). In Recommendation ROM-04/95 (Puertos del Estado 1995) a more specific treatment of the problem is found, because it considers additional parameters for the flow regime (subcritical or supercritical) with which the resultant wake of the wind passing around the body generating the disturbance is related to its development over the body, which is immersed in the wake.

It is within standards and recommendations where the possibility is opened for obtaining the design loads through a more detailed study with which to acquire application results to the specific case under study. It can be achieved by performing physical experiments to a reduced scale in a wind tunnel, or, as in this case, by performing a numerical simulation of the particular case of interest.

In this communication, the approach, methodology, models and results of a series of numerical tests are presented, carried out through Computational Fluid Dynamics techniques for the study of the influence and interaction between successive arrays or tables of a photovoltaic park, due to the wind action. Furthermore, the cases to be tested are detailed, according to the arrays' inclination and the separation between them. This is done with the aim to establish the existing correlation between the forces developed in each of the tables due to the aerodynamic hiding effect between panels' arrays.

## 2 Problem Modeling

To study reality in all its complexity is a task requiring rigor as well as engineering criterion, especially when decisions need to be taken related to problems in which knowledge has not yet advanced enough. One of the ways to address the issue consists in trying to isolate from the rest the phenomenon or parameter which is under analysis, with the aim to understand and interpret better the study results. This reality simplification process is usually at the expense of results reliability when the phenomenon studied has nonlinear characteristics. This happens in almost any type of aerodynamic test, either physical or numerical. Part of the test design is dedicated to trying to reduce imprecisions and uncertainties to a minimum. Obtaining pressure values over the surface of a submerged body in the terrestrial boundary layer is a complex problem, so the current approximation tries to simulate results in different scales (Blocken et al. 2007; Cao 2014).

### 2.1 *Adopted Simplifications*

Based on the usual scheme of a standard photovoltaic park, a series of simplifications of the reality must be assumed in the modeling process (Escrivá-Pla 2015). In this case, to go from reality to model, involves the elimination of the influence of the columns in the analysis, both in the gantry type and the monopole type of support structures, as well as the influence of the possible bracings between gantries which stand in the way of the flow. Both types of structural elements (columns and bracings) or others of a functional type present in the array of photovoltaic panels (connection boxes, electrical conduits, miscellaneous equipment, etc.) will influence the generation of turbulent patterns, but its relative minor significance leads to leave them out of the definition of the concrete geometry to be analyzed.

The grate formed by the lintels and straps that directly support the array of panels will be treated in the same way. As this grate is located just below the panels and its exposed surface is quite reduced (the total panel surface is always much greater), its elements will not be considered either in the flow transfer analysis. Regarding the ground, the roughness of the surface will be modeled through its

influence in the flow behavior. Thus, its characteristics will be defined taking into account the way in which the wind mean velocities logarithmic profile is developed, while as a boundary condition it will be considered that there is no slippage in its surface. Geometrically, the ground will be considered as a horizontal plane.

On a separate issue, this study also focuses on the numerical simulation of the behavior of a fluid—air—and its influence over a blunt body, leaving aside the body deformation, as the body is supposed to be infinitely rigid. To analyze the fluid-structure interaction is a complex problem that can be addressed through the use of response functions of the structure to the wind, whose parameters must be experimentally obtained (Nieto 2006). Another way to do it is to analyze the set of both domains through numeric simulation: on the one hand, the fluid domain, which would be addressed with a similar analysis to the one used in this communication; and on the other hand, the solid domain corresponding to the structure, which, for each time step, would be analyzed and its deformation obtained—in elastic or plastic regime—when subjected to the action of the pressures produced in its contact with the fluid domain, considering that said deformation modifies in turn the action of the pressure field over the deformed structure. The described interaction produces a highly nonlinear problem, which, despite the possibility of its resolution (Jasak and Tuković 2010), requires high calculating power for its resolution, that is not justified in common cases.

## ***2.2 Problems Associated with Turbulence***

Linear and deterministic models, such as laminar flow, are not frequent in the reality of wind fields, and they are relegated, in the majority of cases, to laboratory curiosity or to the application of simplified calculation methods. Thus, the nonlinear and/or random turbulent flow representations—which are not easily treatable in the formal plane—are the ones that prevail around us. Despite this everyday reality, which should shape our perception, there is no capability (with the current knowledge level) of understanding, modeling and predicting nature with total analytic rigor. Hence, the need and suitability of using numerical methods in certain problems, like the one addressed in this study.

In the case in hand, regarding the wind load variation due to the hiding (shadow effect) between panels for photovoltaic generation, an effort has been made to obtain conclusions useful for different structural typologies, panels' arrays, tables' arrangements and field geometries. They should even be useful for different production technologies, beyond photovoltaic, which base their operation in an arrangement of independent elements in space, following certain repetition pattern and at certain height over the ground, with the possible additional condition of having no restriction (blockage) of flow through their lower part. This way, the results obtained could be extrapolated to other similar cases, even though, to attain a higher precision, further studies will be needed to address concrete geometry and/or flow conditions.

### 3 Analysis Methodology

The problem analysis is performed by applying specific techniques of Computational Fluid Dynamics (CFD). The general CFD methodology of analysis applied in this study, can be broken down in the following stages:

1. Analysis of the problem and parameters involved.
2. Actual problem modeling.
3. Definition and processing of geometry.
4. Domain meshing.
5. Resolution through numerical algorithm.
6. Analytic and graphical post processing.
7. Results analysis.

In this particular case, open source programs are used for almost the entire process. First, the geometry is generated through the computer aided drawing program *FreeCAD* and then the geometry is exported to the meshing suite called *Salome*. Hereafter, the generated mesh is visualized and cleaned using the program *MeshLab*. Then, the fluid domain is exported to the program *OpenFOAM*, with which the differential equations of the problem are solved. In this step fluid, flow and solid contour parameters are introduced, as well as the initial and domain boundary conditions, and the simulation calculation time is established. Once the model has been executed, the analytic and graphical post process of the results is performed through various applications, among them the *ParaView* application or the Excel spreadsheet.

Regarding the numerical algorithm selected for resolution, the program *OpenFOAM* has been chosen as stated before. Besides being a collaborative open source project, it is very versatile and modular, allowing the user to access the code and also allowing to modify the code as needed, which facilitates its adaptation to any type of problems (Jasak et al. 2007). This program is widely used in the academic and scientific field, since it has a large users and developer's community, which promotes and sustains the code.

### 4 Numerical Application

This communication seeks to study the influence of spacing between alignments of successive tables, known as hiding or shadow effect, over the resulting forces in each table. It involves seeing how the interposition of the tables located upstream in the acting flow over a specific table affects the development of forces produced by the fluid pressure over this table. The results obtained can be compared to the existing recommendations in literature and standards that deal with the hiding in groups or sequences of structures. To this end, a series of five tables is simulated, considering the first table in the direction of flow travel is the one located at the edge of the field, that is, the first to receive the wind action (it does not have previous hiding).

It is considered that the main directions of the flow correspond to the wind blowing in a perpendicular direction to the superior and inferior edges of the tables, which coincide with the directions in which the support structures work. Of the two main possible directions—wind at  $0^\circ$  and wind at  $180^\circ$ —, the  $0^\circ$  direction is taken as the one with a positive attack angle (flow generates pressure over the superior face of the module). The intermediate wind directions are supposed to produce a global wind resultant over the structure of a lesser absolute value, as can be observed on the standards. For the purpose of obtaining an order of magnitude of the hiding between structures, in this communication, only the main direction corresponding to  $0^\circ$  is tested.

From the intermediate directions, at least those forming  $\pm 30^\circ$ ,  $\pm 60^\circ$ ,  $\pm 120^\circ$  and  $\pm 150^\circ$  should be studied in order to analyze the generation of vortex paths, such as those identified in recommendation PV2-12 (SEAOC 2012). However, due to the local nature of their effects over the surface in which they generate, they will only be relevant to the calculation of pressers (elements for fixing panels to the support structure) and other anchors. However, because of their limited entity, said vortices do not have a greater impact than the wind blowing in the main directions, so that their effect over the total resultants is assumed not to be decision-making.

Three cases of panels' tables with different inclinations,  $\theta$ , with respect to the horizontal ( $10^\circ$ ,  $25^\circ$  and  $40^\circ$ ), are tested, with the aim of studying the effect of this variable over hiding.

#### **4.1 Model Geometry**

The geometry used is a group of five successive tables, each one with arrays formed by a unique row of 10 modules placed in a vertical position [ $1V \times 10$ ] and separated by 20 mm gaps due to pressers. Taking into account that the modeled modules have commercial standard dimensions  $1,955 \times 995 \times 50$  mm, a total table length of 10.130 m is obtained. As can be observed in Fig. 1, the meshing of the entire array surface is considered as a unique connected surface without taking into account gaps or pressers, because if they were taken into account, the mesh would have an extremely big size for the available calculation power. This simplification is justified by the little influence that the separation between modules have over the forces on the tables, as the authors have been able to verify.

The free height under the tables is 0.800 m, being this the normal upper limit in photovoltaic parks. This value is chosen with the aim of obtaining a higher exposition (lesser hiding) of the tables placed leeward of others. This is because when the free height is lower, for the same ground roughness, less inferior flow can affect the following structures. This way, a conservative value of the resulting force on the hidden tables (a higher value) will be obtained.

The decision on the table separation in a real installation is normally taken based on a production criterion, for instance, by establishing the number of hours that it is required to have production without shadows, during the winter solstice. With the



park location (latitude) the panels' inclination is decided considering the solar ecliptic and the specific radiation in the area. With the panels' inclination and the plan area of the park, the maximum height of the arrays is obtained (by applying linear programming it is possible to obtain the maximum of photovoltaic panels' area). With the panels' inclination and the maximum height of the arrays, the separation between tables is determined.

In this case, the separation or distance between tables,  $D$ , is: for  $\theta = 10^\circ$ ,  $D = 0.940$  m; for  $\theta = 25^\circ$ ,  $D = 2.289$  m; and for  $\theta = 40^\circ$ ,  $D = 3.481$  m. On the other hand, the height of the array superior edge over the ground is: for  $\theta = 10^\circ$ ,  $H = 1.139$  m; for  $\theta = 25^\circ$ ,  $H = 1.626$  m; and for  $\theta = 40^\circ$ ,  $H = 2.057$  m. Thus, none of the ratios separation/height studied in the numerical test is higher than 2, which is the value considered in recommendation PV2-12 (SEAOC 2012). So, the sequence of structures constitutes a new boundary (like a displacement layer), which does not allow the re-adherence of the superior flow to the ground surface; thus, similar effects as those indicated in that recommendation are to be expected.

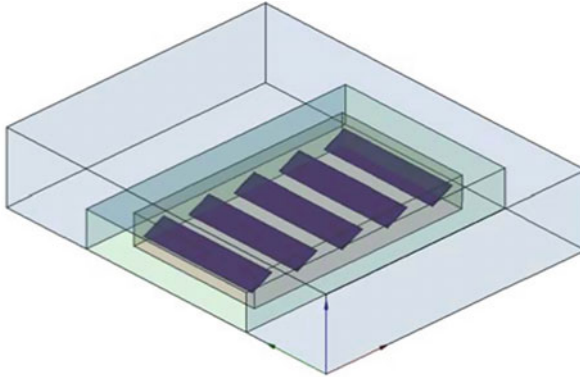
The exterior domain considered has dimensions  $A \times B \times H = A \times 30 \times 6$  m; measure  $A$  depends on the separation between tables and, thus, on the array inclination. The frontal distance to be respected from the flow entrance to the first table is set in 3 m. Taking this into account: for  $\theta = 10^\circ$ ,  $A = 17.329$  m; for  $\theta = 25^\circ$ ,  $A = 23.304$  m; and for  $\theta = 40^\circ$ ,  $A = 27.895$  m. These big dimensions of the numerical model force not to consider a finer mesh resolution in the arrays due to gaps and pressers, according with the prior reasoning, and to use strategies such as division into mesh subdomains.

The intention of the defined test is to obtain the differences between the resultant forces in tables of a same wind case, due to interferences between them and the fluid current. To this end, the reduction of the pressure integral over all the surfaces of each table hidden by other precedent tables in the flow direction will be determined, through the following hiding factor.

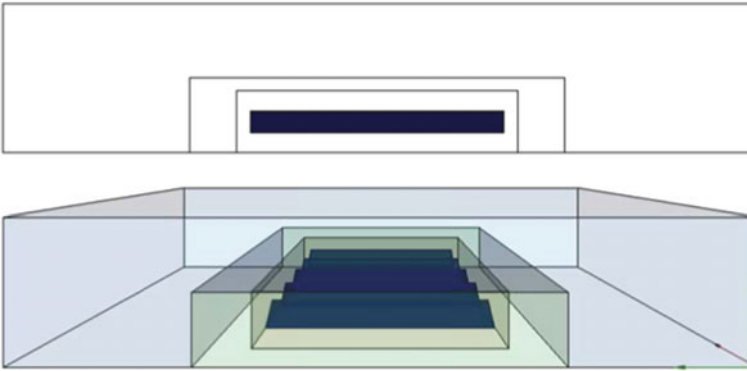
$$\lambda_h = 1 - \frac{F_i}{F_1} \quad (1)$$

where  $F_i$  is the total resultant force due to wind pressure over the  $i$ -th table in the direction of the flow, being  $F_1$  then the force corresponding to the first table exposed to the flow, which is the one with the higher load in every case. The hiding factor measures the reduction of the force due to the aerodynamic shadow effect of some tables over others. This parameter is related immediately with the exposition factor (the load calculated without hiding must be multiplied by this factor), which is normally facilitated in different standards:

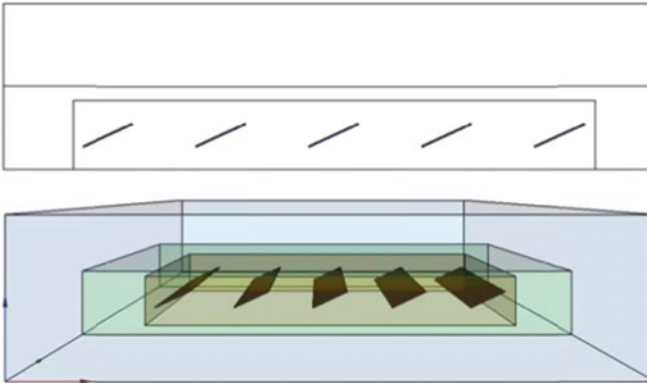
$$\lambda_e = \frac{F_i}{F_1} = 1 - \lambda_h \quad (2)$$



(a) 3D view (axonometric)



(b) Front elevation (projection and conical)



(c) Lateral elevation (projection and conical)

**Fig. 1** Geometric definition of the model for  $\theta = 25^\circ$

## 4.2 Domain Meshing

For the meshing, the package *Salome* is used, because it allows to differentiate between surfaces and subdomains, and also post processing is available from libraries for each surface of each table, and with different mesh resolutions for each subdomain, thus optimizing mesh weights.

The tables are identified as M01 to M05 in the direction of the flow. As a study parameter only the panels' inclination,  $\theta$ , will be considered, according to the above mentioned. The adopted codification is the following:

- G10: inclination  $\theta = 10^\circ$
- G25: inclination  $\theta = 25^\circ$
- G40: inclination  $\theta = 40^\circ$

In the proposed test, the meshed geometries have similar sizes (for the same meshing conditions), despite their different dimensions: between 601,000 and 634,000 nodes; between 3,237,000 and 3,433,000 cells; and mesh archives with UNV format between 414 and 438 MB.

## 4.3 Calculation Parameters

In each case, a RANS (Reynolds-Averaged Navier-Stokes equations) method is used, with a  $k$ -epsilon model for turbulence. The simulation time is set in 4.5 s, which proves to be enough to reach a stable regime in cases with a constant logarithmic profile for velocities as boundary condition, for a domain as the one provided.

The wind average velocity considered in the numerical experiment is 22.5 m/s. The velocity value used is simply a reference value which only influences the concrete value of the forces acting on the tables, but it has practically no effect over the relationship between the forces in different tables, which is the point of interest in this case.

A constant logarithmic profile is simulated as an entry condition. As a temporal variability or a spatial variability in the form of vortex structures is not introduced, this case could also be taken as a case close to the fluid field developed in a terrain with very low superficial roughness and with a flat orography windward of the tables, as in water, ice or sand surfaces. The test performed could also give an idea of the turbulent behavior in this type of terrains, considering that the turbulence distribution is concentrated in scales either very small or too big to be represented inside the domain.

#### 4.4 Results Analysis

In Figs. 2, 3 and 4, the temporal evolution of the forces acting in each table (M01 to M05, in the direction of the flow) is represented for the 3 studied inclination angles (G10, G25 and G40), differentiating in each case between the horizontal component or drag, and the vertical component or lift. The latter one is negative (downwards) in almost all cases, because only the case of wind at  $0^\circ$  is studied, which produces pressure (strictly speaking, because it is not suction) over the superior face of an isolated table. The important reduction of force due to hiding between tables is verified. This reduction tends to be slightly higher when the flow is already stabilized and the hidden table is nearer the first one in the flow direction. This is especially notable for the second table, when the arrays' inclination increases.

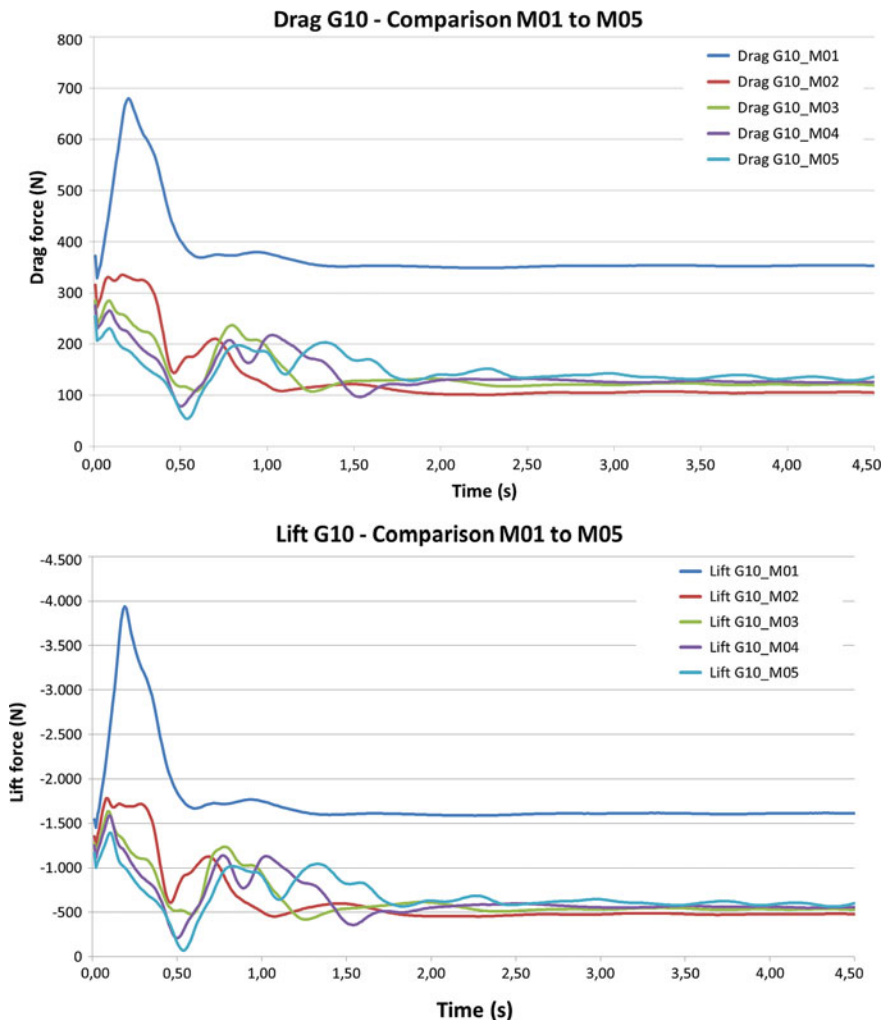


Fig. 2 Drag and lift forces in a group of tables for  $\theta = 10^\circ$

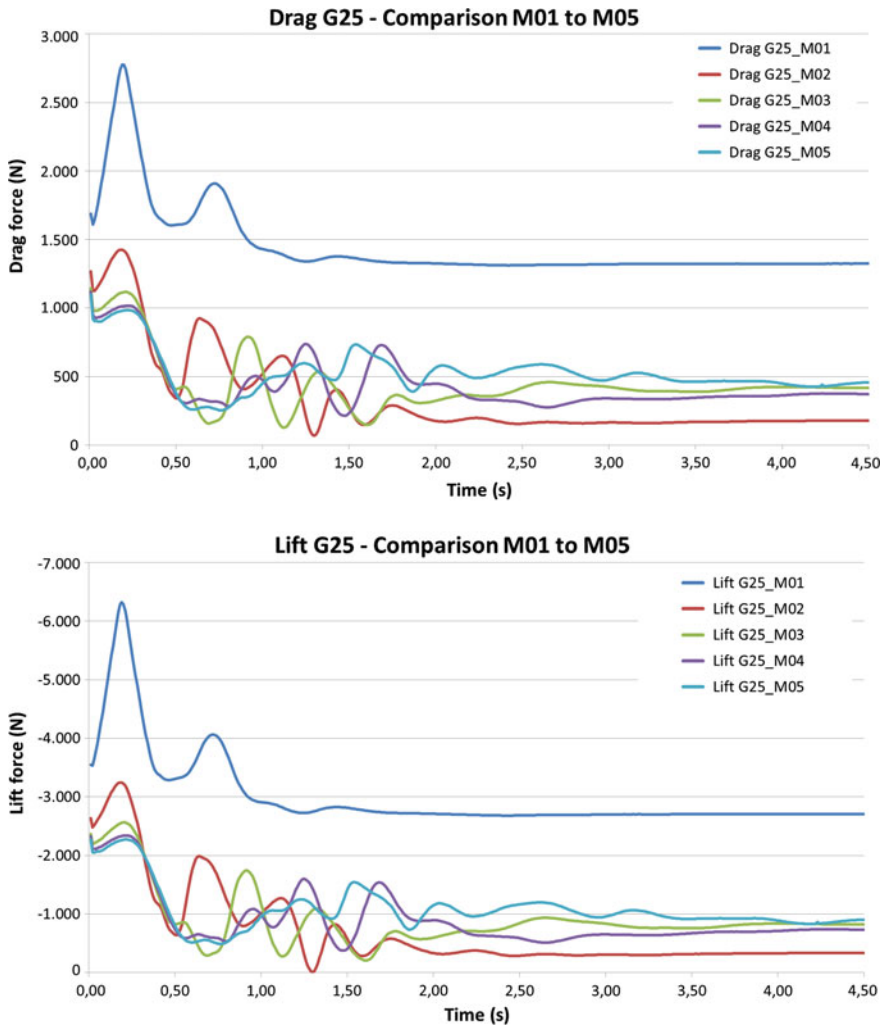


Fig. 3 Drag and lift forces in a group of tables for  $\theta = 25^\circ$

In Table 1, statistical information is provided (mean and median) of the hiding factor (total force reduction parameter) given in Eq. (1) for the total of all times saved in post process, without taking into account the acting force direction. From the obtained results, it can be noted that the hiding influence is very important in solar parks with fixed structures and the force reduction can be evaluated in at least 60–70% for tables located leeward of the first one. This happens despite the lack of blockage of the inferior flow considered in this study. The hiding factor can reach values of 80–90% in the table immediately after the first one, with inclinations higher than  $25^\circ$ . It must be taken into account that the previous values correspond to

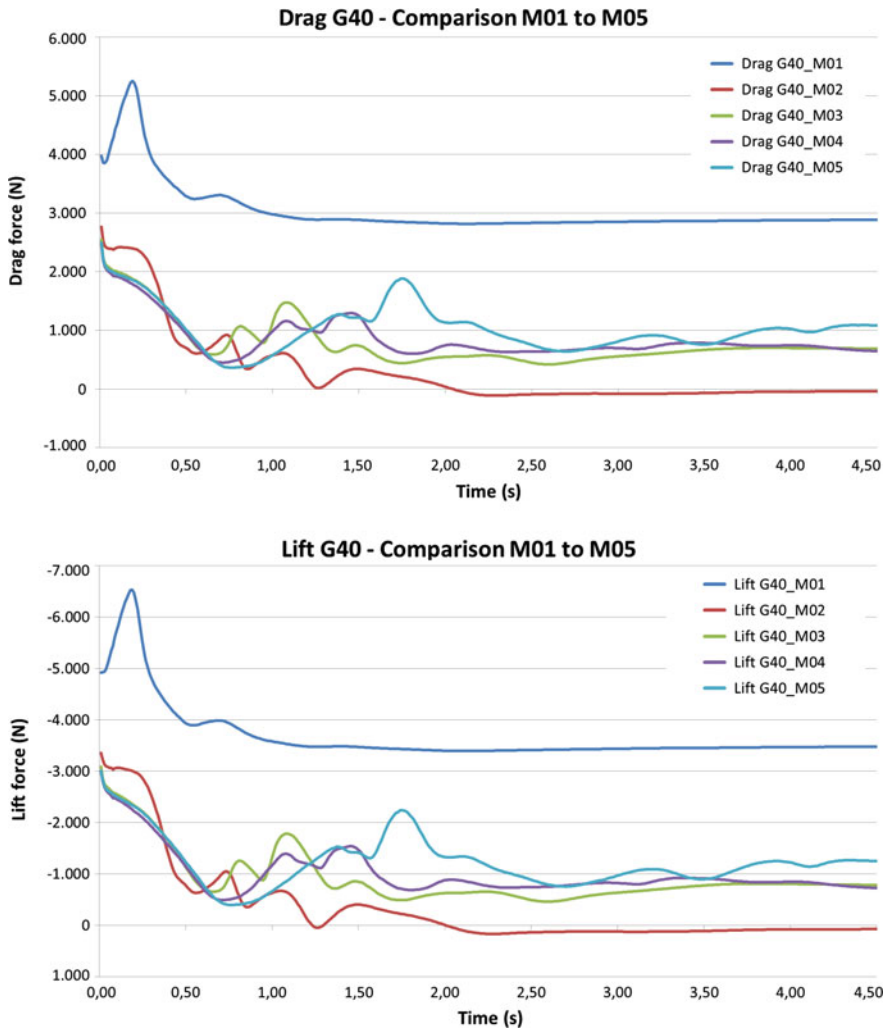


Fig. 4 Drag and lift forces in a group of tables for  $\theta = 40^\circ$

**Table 1** Hiding factor of a table located leeward of others, as a function of the panels' inclination

Table	Hiding factor, $\lambda_h$					
	$\theta = 10^\circ$		$\theta = 25^\circ$		$\theta = 40^\circ$	
	Mean	Median	Mean	Median	Mean	Median
2	0.651	0.702	0.792	0.874	0.895	0.965
3	0.630	0.666	0.705	0.702	0.755	0.771
4	0.624	0.650	0.707	0.740	0.729	0.752
5	0.603	0.619	0.639	0.639	0.668	0.666

an application case with concrete geometry, ground roughness and boundary conditions, but they clearly show the importance of the studied phenomenon.

Values obtained in this study for the exposition factor (around 30–40%, in general) are in line with the order of magnitude of those included in standards that address this phenomenon, among others Recommendation ROM 0.4/95 (Puertos del Estado 1995) and Instruction IAPC/11 (Dirección General de Carreteras 2011). However, discrepancies are observed with values of the exposition factor proposed in Eurocode EC1-1-4/07 (Comité Técnico AEN/CTN-140 2005) for constructive typologies which in occasions have been considered analogous to a succession of panel tables in the absence of other concrete data (e.g., saw tooth roofs). The values of that standard would be excessively conservative according to the results obtained in this study.

## 5 Conclusions

A series of numerical tests of Computational Fluid Dynamics has been presented for the evaluation of the aerodynamic hiding factor between successive photovoltaic panels' arrays or tables. The application to different geometries has allowed obtaining results both of scientific interest and also of engineering usefulness for the project of panels' support structures in solar parks. A specific own methodology has been developed and a versatile work flow adaptable to the hardware circumstances and the calculation context has been established, which allows optimizing the available computing resources.

The importance of hiding between successive tables has been verified, due to the shadow effect of some tables over others. Despite the absence of blockage in the inferior part of the tables, a reduction of the total force acting on an array shielded by others is at least 60–70%, taking as a reference the force corresponding to the first table in the flow direction, which behaves in a similar manner as an exempt array. The force reduction increases to 80–90% in the case of the second table in a group for inclination angles common in mid latitudes (25°–40°). Obtained results are similar in order of magnitude with the exposition factor values included in some standards.

It can be concluded that it is possible to address the calculation of fixed structures of photovoltaic parks by including the hiding effect in a systematic manner. This will be translated in an important cost reduction, both for the structures and for their foundations. The obtained results aim at the convenience of increasing to the maximum the size of the table sectors and the use of plan geometries close to rectangular, as a way to maximize the shadow effect in the entire plant.

## References

- Blocken B, Stathopoulos T, Carmeliet J (2007) CFD simulation of the atmospheric boundary layer: wall function problems. *Atmos Environ* 41(2):238–252
- Cao S (2014) Advanced physical and numerical modeling of atmospheric boundary layer. *J Civ Eng Res* 4(3A):14–19
- Comité Técnico AEN/CTN-140 (2005) UNE-EN 1991-1-4:2007. Eurocódigo 1: Acciones en estructuras. Parte 1-4: Acciones generales. Acciones de viento, EC1-1-4/07, Spanish version of EN 1991-1-4:2005. AENOR, Madrid, Spain
- Dirección General de Carreteras (2011) Instrucción sobre las acciones a considerar en el proyecto de puentes de carretera, IAPC/11. Dirección General de Carreteras, Ministerio de Fomento, Madrid, Spain
- Escrivá-Pla R (2015) Estudio aerodinámico del factor de ocultamiento para la determinación de las cargas de viento a aplicar en el proyecto de centrales fotovoltaicas de generación eléctrica. Aplicación al proyecto de planta solar de 20 MW en Beneixama (Alicante). MSc Thesis, ETSICCP, Universidad Politécnica de Valencia, Spain
- Jasak H, Jemcov A, Tuković Z (2007) OpenFOAM: A C++ library for complex physics simulations. In: Proceedings of the international workshop on coupled methods in numerical dynamics, Dubrovnik, Croatia, 20 pp
- Jasak H, Tuković Z (2010) Dynamic mesh handling in OpenFOAM applied to fluid-structure interaction simulations. In: Proceedings of the 5th European conference on computational fluid dynamics, ECCOMAS CFD 2010, Lisbon, Portugal, 19 pp
- Nieto F (2006) Análisis de sensibilidad y optimización aeroelástica de puentes colgantes en entornos de computación distribuida. PhD Thesis, ETSICCP, Universidad de La Coruña, Spain
- Puertos del Estado (1995) Recomendaciones para obras marítimas: Acciones climáticas II: Viento, ROM-0.4/95. Puertos del Estado, Ministerio de Obras Públicas, Transportes y Medio Ambiente, Madrid, Spain
- Sánchez-Carratalá CR (2012) Bases para el proyecto de cimentaciones de pilotes hincados para estructuras de apoyo de placas en parques solares fotovoltaicos. In: Proceedings of the 16th international congress on project engineering, ICPE2012, AEIPRO, Valencia, Spain, pp 1404–1415
- SEAOC (2012) Wind design for low-profile solar photovoltaic arrays on flat roofs, PV2-12. Structural Engineers Association of California, Sacramento, CA
- Tomás A, Morales M (2012) Revisión y estudio comparativo de la acción del viento sobre las estructuras empleando Eurocódigo y Código Técnico de la Edificación. *Inf Constr* 64 (527):381–390



**Part VI**  
**Safety, Labour Risks and Ergonomics**

# Assessment of the Thermal Stress Risk During the Construction of a Warehouse



J. L. Fuentes-Bargues, A. M. Revuelta-Arno  
and M. C. González-Cruz

**Abstract** The existence of extreme thermal conditions in the workplace is a source of problems affecting both the health of workers and the efficient development of labor activities. Thermal environments, where heat and humidity are too high, can become a risk to the workers' health. Similarly, the thermal discomfort in the working environment is directly reflected in productivity. The exposition to a warm environment is assessed through the evaluation or calculation of the thermal stress, i.e. determining the net heat load to which workers are exposed which is the combined contribution of environmental conditions in the work place, the physical activity performed and the characteristics of the clothes they wear. The purpose of this communication is to perform an initial assessment of the risk of thermal stress in normal workplaces during the construction of an industrial building located in Ribarroja of Turia (Valencia).

**Keywords** Thermal stress · Industrial facility · Risks evaluation  
Thermal discomfort

## 1 Introduction

The existence of extreme thermal conditions in the work environment is an important source of problems that affects both workers' health and the efficient development of labor activities.

The need to work or even live in thermal comfort conditions is an innate idea for the human being. If the environmental conditions in which the labor activity is

---

J. L. Fuentes-Bargues (✉) · M. C. González-Cruz  
GIDDP, Dpto. de Proyectos de Ingeniería, Universitat Politècnica de València,  
Camino de Vera s/n, 46022 Valencia, Spain  
e-mail: jofuebar@dpi.upv.es

A. M. Revuelta-Arno  
Escuela Técnica Superior de Ingenieros Industriales, Universitat Politècnica  
de València, Camino de Vera s/n, 46022 Valencia, Spain

developed are cold or warm, workers can be subjected to an uncomfortable situation (Diego-Mas 2015). When these conditions exceed certain limits, this discomfort can become dangerous for the health and safety of individuals.

This is the basic concept of thermal stress, that is, the heat net load to which workers are exposed. It results from the combined contribution of the work place environmental conditions, the physical activity the workers engaged in and the characteristics of the workers' clothes (INSHT 1993).

A medium or moderate thermal stress can make work performance difficult, but when the stress level approaches the human body tolerance levels, the risk of disorders resulting from cold or heat exposure increases. The main factors which determine the potential thermal stress are: air temperature, relative humidity, wind velocity, radiation, metabolic activity and type of clothing. Moreover, there are personal risk factors which affect individual tolerance to thermal stress, such as age, obesity, hydration, medicine or alcoholic beverages intake, gender or acclimatization.

Thermal stress calculation constitutes the basis for thermal environment evaluation, but it cannot anticipate in an accurate manner if the conditions on which a person works constitute a risk for his health, because it depends on individual factors which are different for each person. The physiological response of each individual is determined by the thermal overload concept. The parameters that allow to control and determine thermal overload are body temperature, heart rate and the perspiration rate.

Many studies can be found on the different ways to perform thermal stress calculation, depending on the region, the type of activities that are being analyzed, the climate of the zone or the parameters which are taken into consideration to perform the analysis (Table 1).

**Table 1** Main Thermal Stress assessment methods

Assessment index	Authors	Stress type	Data requirement, not provided by the station network
WBGT Index	Yaglou and Minard (1957)	Heat	Yes
Required sweat rate	Vogt et al. (1981)	Heat	Yes
IREQ Index	Holmer (1984)	Cold	Yes
ISC Index	Belding and Hatch (1955)	Heat and cold	Yes
Fanger method	Fanger (1970)	Heat and cold	Yes
Humidex index	Masterton and Richardson (1979)	Heat	No
Wind-Chill index	Environment Canada (2001)	Cold	No

Source Barrasa-Rioja et al. (2013)

A quantification of the thermal stress in outdoor labors, both prior and during the execution of such activities allows to stablish behavior and work patterns on extreme temperature conditions (both cold and heat) and to prevent serious health consequences (and at times fatal) for workers. In this field, studies have been performed on how to quantify thermal stresses on outdoor labors (Martínez-García 2008) and more specific ones, such as thermal stress studies on greenhouse construction labor in Almería (Callejón et al. 2011) and outdoor labor in the Pontevedra province (Barrasa-Rioja et al. 2013).

The aim of this communication is to perform an initial thermal stress risk assessment for the most frequent workstations during the construction of an industrial building, in this case located in Ribarroja of Turia (Valencia).

## 2 Methodology

The method to be applied for the thermal stress assessment depends on the zone where the industrial plant is to be located. In this case, the zone is humid and hot, so the WBGT (Wet Bulb Globe Thermometer) Index has been selected. Once the WBGT is calculated, it is determined if the thermal stress risk situation is admissible or not.

According to this situation, the thermal environment could be analyzed in a more detailed manner by using another two indexes (Fig. 1). The Fanger Method (1970) calculates the Predicted Mean Vote (PMV) Index and the Predicted Percentage Dissatisfied (PPD) Index. These indexes are useful if the thermal situation is one of

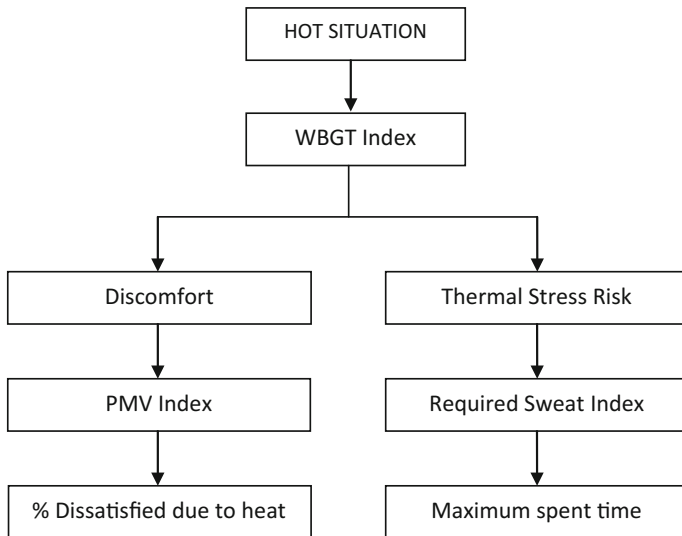


Fig. 1 Thermal environment assessment indexes Source NTP-322 (INSHT)

discomfort but it does not generate an elevated risk. It gives detailed information on the percentage dissatisfied due to heat. In case of thermal stress risks, the Required Sweat Rate method is used (Vogt et al. 1981), because it provides complementary information about the time spent under the situation causing such risk.

### 2.1 The WBGT Index

The WBGT method or index, initially developed by Yaglou and Minard in 1957, is a world-renown method and included in many countries' labor risks prevention. In Spain, this method is included in the Technical Prevention Note (TPN) TPN-322 (INSHT 1993).

In this method, the environmental dry temperature and ( $T_a$ ), the natural humid temperature ( $T_{HN}$ ) and the globe temperature ( $T_G$ ) are taken into account and the calculation is performed according to Eqs. (1) and (2):

$$WBGT = 0.7 \cdot T_{HN} + 0.3 \cdot T_G(^{\circ}C) \text{ (without sun exposure)} \quad (1)$$

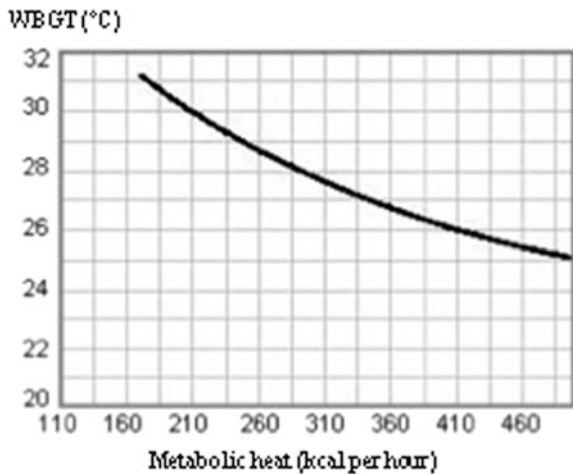
$$WBGT = 0.7 \cdot T_{HN} + 0.2 \cdot T_G + 0.1 \cdot T_a(^{\circ}C) \text{ (with sun exposure)} \quad (2)$$

This index must not exceed a certain limit value which depends on the metabolic heat that each individual generates during work ( $M$ ). The maximum value that the WBGT index can reach, according to the value  $M$  adopts, is determined in Fig. 2, which is described in TPN 322 (INSHT 1993).

The WBGT adds an Eq. (3) with which the appropriate regime of work and rest can be determined:

$$f_i = \frac{(A - B)}{(C - D) \cdot (A - B)} \cdot 60 \quad (3)$$

**Fig. 2** Limit values of the WBGT index *Source* TPN-322 (INSHT)



For an acclimated person who remains in the work place during the entire break, this expression simplifies to (4):

$$f_t = \frac{33 - B}{33 - D} \cdot 60 \quad (4)$$

where

- $f_t$  work time fraction with respect to total time (min/hour)
- A limit WBGT during rest ( $M < 100$  kcal/h)
- B WBGT in the resting zone
- C WBGT in the work zone
- D WBGT limit during work

This equation allows establishing the amount of time a person must work per hour so the organism is capable to reestablish its thermal balance. This way, it makes sure that the resting zone environment (B) is lower than the WBGT allowed limit in this zone. Otherwise, rest will not fulfil its function due to the absence of a more pleasant thermal environment which allows workers to recover before going back to work.

## 2.2 The Required Sweat Method

The Required Sweat Method is a more complex index, but its use, usually as a complement of the WBGT index, allows obtaining very accurate results. The methodology is based on the comparison between skin humidity and sweat production necessary under specific work conditions. To this end, a series of intermediate parameters are determined: the required evaporation ( $E_{req}$ ) to maintain the organism' thermal balance, maximum evaporation allowed by environmental conditions and the skin' required humidity ( $SW_{req}$ ), according to the expression (5) (INSHT 1994).

$$SW_{req} = E_{req} / r_{req} \quad (5)$$

where:  $SW_{req}$  is the required sweating expressed in  $W/m^2$ . Its equivalence in water loss by sweating is  $(W/m^2)/0.68 = SW_{req}$  ( $gr/m^2$  h). The term  $r_{req}$  is the sweat fraction that drips due to the skin local humidity.

The required evaporation ( $E_{req}$ ) is the amount necessary to maintain the body' thermal balance and, consequently, to make the heat storage equal to zero. It is obtained with the Eq. (6):

$$E_{req} = M - C - R - C_{res} - E_{res} \quad (6)$$

where:

- M is the metabolic energy production
- C is the heat exchanged by convection

- R is the heat exchanged by radiation  
 C<sub>res</sub> is the heat exchanged by respiratory convection  
 E<sub>res</sub> is the latent heat exchanged through breathing

### 2.3 The Fanger Method

The Fanger Method is one of the more extended for thermal comfort estimation. This method calculates two indexes: the Predicted Mean Vote (PMV) and the Predicted Percentage Dissatisfied (PPD) (AENOR 2006). Both indexes provide information on the thermal environment, from the individual clothing characteristics, the metabolic rate, air temperature, mean radiant temperature, wind velocity, or the relative humidity.

The predicted mean vote reflects the mean thermal sensation of a large group of people in a seven level scale (cold, fresh, slightly fresh, neutral, slightly warm, warm and hot), while the predicted percentage dissatisfied takes into account those people whose thermal sensation differs from the predicted mean value.

The predicted mean vote calculation is achieved using the “comfort equation” developed by Fanger which is shown in Fig. 3.

$$PMV = [0.303 * \exp(-0,036 M) + 0,028] * \left\{ \begin{aligned} &(M - W) - 3,05 * 10^{-3} * [5733 - 6,99 * (M - W) - p_a] - 0,42 * [(M - W) - 58,15] \\ &- 1,7 * 10^{-5} * M * (5867 - p_a) - 0,0014 * M * (34 - t_a) \\ &- 3,96 * 10^{-8} * f_{cl} * \left[ (t_{cl} + 273)^4 - (\bar{t}_r + 273)^4 \right] - f_{cl} * h_c * (t_{cl} - t_a) \end{aligned} \right\}$$

Donde:

$$t_{cl} = 35,7 - 0,028 * (M - W) - I_{cl} * \left\{ 3,96 * 10^{-8} * f_{cl} * \left[ (t_{cl} + 273)^4 - (\bar{t}_r + 273)^4 \right] - f_{cl} * h_c * (t_{cl} - t_a) \right\}$$

$$h_{cl} = \begin{cases} 2,38 * |t_{cl} - t_a|^{0,25} & \text{para } 2,38 * |t_{cl} - t_a|^{0,25} > 12,1\sqrt{v_{ar}} \\ 12,1\sqrt{v_{ar}} & \text{para } 2,38 * |t_{cl} - t_a|^{0,25} < 12,1\sqrt{v_{ar}} \end{cases}$$

$$f_{cl} = \begin{cases} 1,00 + 1,290 * I_{cl} & \text{para } I_{cl} \leq 0,078 m^2 k / w \\ 1,05 + 0,645 * I_{cl} & \text{para } I_{cl} > 0,078 m^2 k / w \end{cases}$$

M is the metabolic rate in W/m<sup>2</sup>  
 W is the effective mechanical power in W/m<sup>2</sup> (it can be estimated as zero)  
 I<sub>cl</sub> is the clothing insulation in m<sup>2</sup>K/W  
 F<sub>cl</sub> is the clothing surface factor  
 t<sub>a</sub> is the air temperature in C°  
 t<sub>r</sub> is the radiant mean temperature in C°  
 v<sub>ar</sub> is the air relative velocity in m/s  
 p<sub>a</sub> is the water vapor partial pressure in Pa  
 p<sub>a</sub> = RH/100 \* exp(16,6536 - 4040,183 / (t<sub>a</sub> + 235))  
 where RH is the air relative humidity measured in percentage  
 h<sub>c</sub> is the convection heat transfer coefficient in W/(m<sup>2</sup>K)  
 t<sub>cl</sub> is the temperature in the clothing surface in C°

Fig. 3 Fanger equation Source Diego-Mas (2015)

**Table 2** Thermal sensation classification according to PMV values

PMV values range	Thermal sensation
+3	Hot
+2	Warm
+1	Slightly warm
0	Neutral
-1	Slightly cool
-2	Cool
-3	Cold

From PMV, the value for the environmental thermal sensation is established studied according to Table 2.

This value is completed by the Predicted Percentage Dissatisfied (PPD) (expression 7) calculated from the PMV, where those votes scattered around the mean value obtained are analyzed. It represents the number of persons who would consider the thermal sensation as unpleasant, too cold or too hot.

$$PPD = 100 - 95 * \exp(-0.03353 * PMV^4 - 0.2179 * PMV^2) \tag{7}$$

If the Predicted Mean Vote value is in the range between -0.5 and 0.5, it will reflect a pleasant thermal situation, comfortable for most workers. In other case, the situation will be considered inadequate and corrective measures should be taken to improve the thermal sensation. It must be highlighted that if the results for PMV exceed the range between -2 (cool environment) and +2 (warm environment), it is advisable to use other thermal stress assessment methods to obtain more accurate results. Furthermore, values of Predicted Percentage Dissatisfied (PPD) up to 10% will reflect a satisfactory situation for most people (90% satisfied), while higher values could indicate a thermal discomfort situation, and their possible causes must be analyzed.

### 3 Case Study

The aim of this work is to perform an initial assessment of the thermal stress risk that workers could suffer during the construction of an industrial facility (Fig. 4), located in Ribarroja de Turia (Valencia). Based on the construction project of the industrial plant carried out by Fuentes-Bargues et al. (2014) the following work positions have been identified in order to perform the thermal stress assessment: Earth movements, Foundation, Structures, Forging, Enclosures, Covering, Sanitation network, Paving, Masonry, Electrical installations, Plumbing and Fire protection installations, and Metallic carpentry and locksmith.

For the WGBT index calculation, it is necessary to know the globe temperature, as well as the natural humid temperature. These temperatures are measured in situ, but as the objective is to perform an initial evaluation of the work, some





**Fig. 4** Industrial plant images *Source* Elaborated by the authors

approximations are established. The dry air temperature  $T_a$  is obtained from the data gathered by the nearest weather station (Valencia-Airport) of the Agencia Estatal de Meteorología (AEMET 2015). It has been considered that the globe temperature  $T_G$  is higher than  $T_a$  inside a range from 7 to 9 °C and the natural humid temperature ( $T_{HN}$ ) can be considered lower than  $T_a$  in a range between -3 and -5 °C. Specifically for this study, an increase of +9 °C over the  $T_a$  has been considered, for  $T_{Gmáx}$ , +8 °C for  $T_{Gmean}$ , +7 °C for  $T_{Gmin}$ , -3 °C for  $T_{HNmáx}$ , -4 °C for  $T_{HNmean}$  and -5 °C for  $T_{HNmin}$ . With these data, WBGT values are obtained for the place where work will be developed (Table 3).

**Table 3** WBGT index for the case study

	WBGT					
	In the building interior or exterior without solar radiation			Exterior with solar radiation		
	WBGT <sub>max</sub>	WBGT <sub>mean</sub>	WBGT <sub>min</sub>	WBGT <sub>max</sub>	WBGT <sub>mean</sub>	WBGT <sub>min</sub>
January	16.4	10.8	5.1	15.5	10	4.4
February	17.4	11.7	5.9	16.5	10.9	5.2
March	19.9	13.9	7.8	19	13.1	7.1
April	21.7	15.8	10	20.8	15	9.3
May	24.7	19	13.4	23.8	18.2	12.7
June	28.4	23	17.5	27.5	22.2	16.8
July	31.2	31.2	25.8	20.5	30.3	25
August	31.4	31.4	26.2	20.9	30.5	25.4
September	28.6	28.6	23.3	18	27.7	22.5
October	24.7	24.7	19.3	13.9	23.8	18.5
November	19.9	19.9	14.5	9.2	19	13.7
December	16.8	16.8	11.5	6.1	15.9	10.7

*Source* Elaborated by the authors

For PMV, PPD and the required sweat indexes calculation, it is considered that workers are acclimated to the Valencia climate. In case there are workers who are not acclimated, they will have a prior period of 5–6 days to achieve a progressive acclimation. For metabolic consumption calculation of each work station, the durations of the work stations’ different tasks has been estimated in one hour cycles, assuming that the working day is 8 h. Another initial necessary factor for the index calculation (PPD, PMV, Required sweat) is the clothing insulation. All workers are required to wear a coverall and safety boots. The rest of the clothing will vary depending on the season. Based on the insulation data from table C.2 of the Appendix C of the UNE-EN ISO 7730 standard, the workers insulation has been estimated for every month of the year (Table 4).

The metabolic consumption depends on the individual metabolism (although it has been assumed that the worker is acclimated, so this aspect is of lesser importance), on the activity type and the activity duration time. The metabolic consumption is estimated from the values on Table 5 (AENOR 2005; INSHT 1993) always adding the basal metabolism (1 kcal/min).

Once all prior data is available, the WGBT, PPV, PPD and the Required Sweat indexes are calculated for each one of the identified work stations. As an example, the task Structure is shown here. In this work station, workers perform the welding and assembling of the beams on the floor and subsequently they assemble pillars, beams and other elements using a crane (Fig. 5). As the different parts are assembled, welders do their work, using for both tasks, either scissors or basket articulated platforms, according to the specific case. To this work station the

**Table 4** Workers insulation due to the clothes used

MES	Underwear	Undershirt	Trousers	Sweaters and Jackets	Shoes and socks	Coveralls	Safety boots	I <sub>cl</sub> (clo)
January	0.03	0.04	0.25	0.35	0.1	0.55	0.1	1.42
February	0.03	0.04	0.25	0.35	0.1	0.55	0.1	1.42
March	0.03	0.04	0.06	0.2	0.1	0.55	0.1	1.08
April	0.03	0.04	0.06	0.2	0.1	0.55	0.1	1.08
May	0.03	0.04	0	0	0.02	0.55	0.1	0.74
June	0.03	0.04	0	0	0.02	0.4	0.1	0.59
July	0.03	0.04	0	0	0.02	0.4	0.1	0.59
August	0.03	0.04	0	0	0.02	0.4	0.1	0.59
September	0.03	0.04	0	0	0.02	0.55	0.1	0.74
October	0.03	0.04	0.06	0	0.02	0.55	0.1	0.8
November	0.03	0.04	0.06	0.12	0.1	0.55	0.1	1
December	0.03	0.04	0.25	0.35	0.1	0.55	0.1	1.42

Source Elaborated by the authors

**Table 5** Values for the metabolic consumption calculation

Body position and movement		Work type			
	Kcal/min			Mean (Kcal/min)	Range (Kcal/min)
Seated	0.3	Manual work	Light	0.4	0.2–1.2
			Heavy	0.9	
Standing	0.6	Work with one arm	Light	1	0.7–2.5
			Heavy	1.7	
Walking	2.0–3.0	Work with both arms	Light	1.5	1.0–3.5
			Heavy	2.5	
Walking up a slope	Add 0.8 per meterwalked on the slope	Work with the body	Light	3.5	2.5–15.0
			Moderate	5	
			Heavy	7	
			Very heavy	9	

Source TPN-322 (INSHT)



**Fig. 5** Structure Works *Source* Elaborated by the authors

insulation value obtained in Table 4 will be added, corresponding to the apron, globes and for the safety goggles or welding helmet. This adds an additional insulation of 0.45clo. Table 6 shows the calculation of the metabolic consumption for the work station Structure.

With the value of M, the limit WBGT index can be calculated. In this case, this value is 28.78 °C. If this value is compared with the WBGT value calculated for external values with solar radiation (Table 3), the results show that in July and August there is risk for thermal stress. With this limit value and assuming that workers take their brake in the work site or very near, with expression (4) it is

**Table 6** Metabolic consumption for the Structure work station

Activity		Metabolic rate	Time (min)	Time (%)	M (Kcal/min)
Assembling and unloading materials	Standing	0.6	10	16.67	0.35
	Working with two arms—Light	1.5			
Assembly	Standing	0.6	20	33.33	1.87
	Working with the body—Moderate	5			
Welding	Standing	0.6	30	50.00	1.05
	Working with two arms—Light	1.5			
Basal metabolism					1.0
Total metabolic consumption M					4.27

Source Elaborated by the authors

**Table 7** PMV and PPD indexes for the structure work station

Station	Month	M(W/m <sup>2</sup> )	tr (°C)	to (°C)	PMV	PPD
3.- Structure	January	163.84	29.25	19.87	1.69	61.22
	February	163.84	30.15	20.77	1.69	61.22
	March	163.84	32.35	22.97	1.38	44.45
	April	163.84	34.25	24.87	1.38	44.45
	November	163.84	32.95	23.57	1.38	44.45
	December	163.84	29.95	20.57	1.69	61.22

Source Elaborated by the authors

**Table 8** Estimated overload Index for structure work

Station	Month	E <sub>req</sub>	E <sub>max</sub>	w <sub>req</sub>	r <sub>eq</sub>	SW <sub>req</sub>
3.- Structure	January	107.10	644.84	0.55	0.85	125.96
	February	107.89	644.10	0.28	0.96	112.20
	March	108.20	765.13	0.24	0.97	111.27
	April	110.08	763.09	0.24	0.97	113.24
	November	108.33	799.52	0.23	0.97	111.38
	December	107.71	644.26	0.28	0.96	112.11

Source Elaborated by the authors

**Table 9** Thermal stress risk summary for cold months

	Jan	Feb	Mar	Apr	May	Jun	Jul	Aug	Sep	Oct	Nov	Dec
1	Orange				Grey	Grey	Grey	Grey	Grey	Grey	Orange	
2	Grey	Grey	Grey	Grey	Grey	Grey	Grey	Grey	Grey	Grey	Grey	Grey
3	Orange		Yellow	Yellow	Grey	Grey	Grey	Grey	Grey	Grey	Yellow	Orange
4	Orange				Grey	Grey	Grey	Grey	Grey	Grey	Orange	Orange
5	Yellow	Yellow	Yellow	Yellow	Grey	Grey	Grey	Grey	Grey	Grey	Yellow	Yellow
6	Orange				Grey	Grey	Grey	Grey	Grey	Grey	Orange	
7	Yellow	Yellow	Yellow	Yellow	Grey	Grey	Grey	Grey	Grey	Grey	Yellow	Yellow
8	Grey	Grey	Grey	Grey	Grey	Grey	Grey	Grey	Grey	Grey	Grey	Grey
9	Orange				Grey	Grey	Grey	Grey	Grey	Grey	Orange	
10	Yellow	Yellow	Yellow	Yellow	Grey	Grey	Grey	Grey	Grey	Grey	Yellow	Yellow
11	Yellow	Yellow	Yellow	Yellow	Grey	Grey	Grey	Grey	Grey	Grey	Yellow	Yellow
12	Orange	Orange	Orange	Orange	Grey	Grey	Grey	Grey	Grey	Grey	Orange	Orange
1. Earth Movements; 2.Foundation ; 3. Structure; 4. Forging; 5. Enclosures; 6. Covering; 7. Sanitation network.; 8. Paving; 9. Masonry; 10. Electrical installations; 11. Plumbing and Fire protection installations; 12. Metallic carpentry and locksmith.												
	There is an important risk for the workers to suffer from thermal stress						Situation is very near to the limit for thermal stress risk.					
	There is no risk, but workers have a hot thermal sensation						Workers are in an acceptable thermal situation.					
	Calculation has not been possible. It should be analyzed by other methods.											

obtained that in July a break should be allowed every 51 min and in August, every 44 min. Subsequently, the thermal stress risk is determined for the structure assembly for the colder months, with the PMV and PPD indexes (Table 7) and with the estimated overload index (Table 8).

PMV values for January, February and December indicate that operators work in a hot thermal situation, with a 61.22% of dissatisfied people. However, the estimated thermal overload index reflects that the required sweat and the required skin humidity do not reach alarm or danger levels. It allows concluding that, in spite of an important percentage of dissatisfied people, there is no risk for thermal stress, but the workers have a thermal discomfort sensation due to their activity. In Tables 9 and 10 a summary is presented of the initial assessment of the thermal stress risk for cold months, according to the PMV index and the Estimated Thermal Overload Index, and for the hot months with the WGBT index.

**Table 10** Thermal stress risk summary for hot months

	Jan	Feb	Mar	Apr	May	Jun	Jul	Aug	Sep	Oct	Nov	Dec
1												
2												
3												
4												
5												
6												
7												
8												
9												
10												
11												
12												
1. Earth Movements; 2.Foundation; 3. Structure; 4. Forging; 5. Enclosures; 6. Covering; 7. Sanitation network.; 8. Paving; 9. Masonry; 10. Electrical installations; 11. Plumbing and Fire protection installations; 12. Metallic carpentry and locksmith.												
	There is an important risk for the workers to suffer from thermal stress						Situation is very near to the limit for thermal stress risk.					
	There is no risk, but workers have a hot thermal sensation						Workers are in an acceptable thermal situation.					
	Calculation has not been possible. It should be analyzed by other methods.											

## 4 Conclusions

An initial thermal stress assessment for outdoor works and for inside works that will be performed during an industrial plant construction, allows identifying those works and times of the year that can represent thermal stress risks, both for heat and for cold. This information allows to adopt organizational decisions during the execution of the work (work hours, break times, etc.) and also to have the adequate individual protection equipment. These initial studies should be complemented with an in situ measurement during the work execution, with the aim of verifying the assumed theoretical climatological data. This measurement will also allow to verify the influence of the worker who hold each one of the evaluated positions in this initial assessment.

## References

- Agencia Estatal de Meteorología (AEMET) (2015) Datos abiertos\Catálogo de Datos. In: AEMET. [www.aemet.es/es/datos\\_abiertoscatalogo](http://www.aemet.es/es/datos_abiertoscatalogo). Accessed. 31 Jan 2016
- Asociación Española de Normalización y Certificación (AENOR) (2005) UNE-EN ISO 8996:2005. Ergonomía del ambiente térmico. Determinación de la tasa metabólica (ISO 8996:2004)
- Asociación Española de Normalización y Certificación (AENOR) (2006) UNE-EN ISO 7730:2006. Ergonomía del ambiente térmico. Determinación analítica e interpretación del bienestar térmico mediante el cálculo de los índices PMV y PPD y los criterios de bienestar térmico local
- Barrasa-Rioja M, Lamosa-Quinteiro S, Álvarez-Díaz M (2013) Estudio del riesgo de estrés térmico en trabajos al aire libre en la provincia de Pontevedra (Galicia). In: AEIPRO (Ed.) Libro de Actas of 17th international congress on project management and engineering, Logrono, pp 1218–1229
- Belding HS, Hatch TF (1955) Index for evaluating heat stress in terms of resulting physiological strains. *Heating Pip, Air Conditioning* 27:129–136
- Callejón AJ, Manzano F, Diaz M, Carreño J (2011) Improving the climate safety of workers in Almería-type greenhouses in Spain by predicting the periods when they are most likely to suffer thermal stress. *Appl Ergon* 42:391–396
- Diego-Mas JA (2015) Evaluación del confort térmico con el método de Fanger. In: Ergonautas, Universitat Politècnica de València. <http://www.ergonautas.upv.es/metodos/fanger/fanger-ayuda.php>. Accessed 16 May 2016
- Environment Canada (2001) Canada's new windchill index. <http://www.ec.gc.ca/meteo-weather/default.asp?lang=n&n=5F816A-1>. Accessed 31 Jan 2016
- Fanger PO (1970) *Thermal comfort*. Mc Graw Hill, New York
- Fuentes-Bargues JL, Fuentes-Bargues D, Sanchis-Llopis A (2014) Proyecto de Ejecución de Nave Industrial sin uso específico en Ribarroja del Turia (Valencia)
- Holmér I (1984) Required clothing insulation (IREQ) as an Analytical Index of Cold Stress. *ASHRAE Trans* 90(1)
- Instituto Nacional de Seguridad e Higiene en el Trabajo (INSHT) (1993) TPN 322: Valoración del riesgo de estrés térmico: Índice WBGT
- Instituto Nacional de Seguridad e Higiene en el Trabajo (INSHT) (1994) TPN 350: Evaluación del estrés térmico. Índice de sudoración requerida
- Martínez-García A (2008) Cómo cuantificar el estrés térmico en trabajos al aire libre: Tasas metabólicas. *Gestión práctica de riesgos laborales: Integración y desarrollo de la gestión de la prevención* 46:46–51
- Masterton J, Richardson FA (1979) Humidex, a method of quantifying human discomfort due to excessive heat and humidity. Environment Canada, Downsview, Ontario
- Vogt JJ, Candas V, Libert JP, Daull F (1981) Required sweat rate as an index of thermal strain in industry. In: Cena K, Clark JA (eds) *Bioengineering, thermal physiology and comfort*. Elsevier, Amsterdam, pp 99–110
- Yaglou CP, Minard D (1957) Control of heat casualties at military training centers. *AMA Arch Ind Health* 16:302–316